

# FOREWORD

Dear Customer,

Thank you for selecting your new Kia vehicle.

As a global car manufacturer focused on building high-quality vehicles with exceptional value, Kia is dedicated to providing you with a customer service experience that exceeds your expectations.

This Owner's Manual is valid for all variants of your model, and describes all options, features, and equipment available, along with the maintenance needs. Therefore, this manual may also describe optional equipment not purchased on your vehicle, country specifications, and functions and features not available in your region. Please always keep this manual in the vehicle for your and any subsequent owner's reference.

Authorized Kia Dealerships provide factory-trained technicians, utilized recommended special service tools, and supply genuine Kia replacement parts to help you maintain and service your vehicle during your ownership.

All information contained in this Owner's Manual was accurate at the time of publication. However, as Kia continues to make improvements to its products, the company reserves the right to make changes to this manual or any of its vehicles at any time without notice and without incurring any obligations.

Please drive safely, and enjoy your Kia vehicle!

© 2022 Kia Canada Inc.

All rights reserved. Reproduction by any means, electronic or mechanical, including photocopying, recording, or by any information storage and retrieval system or translation in whole or part is not permitted without written authorization from Kia Canada Inc.

Printed in Korea



## How to use this manual

We want to help you get the greatest possible driving experience from your vehicle. Your Owner's Manual can assist you in many ways.

We strongly recommend that you read the entire manual. In order to minimize the chance of death or injury, you must read the WARNING and CAUTION sections in the manual.

Illustrations complement the words in this manual to best explain how to enjoy your vehicle. By reading your manual, you learn about features, important safety information, and driving tips under various road conditions.

The general layout of the manual is provided in the Table of Contents. Use the index when looking for a specific area or subject, it has an alphabetical listing of all information in your manual.

Chapters: This manual has nine chapters plus an index. Each chapter begins with a brief list of contents so you can tell at a glance if that chapter has the information you want.

You will find various WARNINGS, CAUTIONS, and NOTICES in this manual. These WARNINGS were prepared to enhance your personal safety. You should carefully read and follow ALL procedures and recommendations provided in these WARNINGS, CAUTIONS and NOTICES.

### **WARNING**

A WARNING indicates a situation in which harm, serious bodily injury or death could result if the warning is ignored.

---

### **CAUTION**

A CAUTION indicates a situation in which damage to your vehicle could result if the caution is ignored.

---

### **NOTICE**

A NOTICE indicates interesting or helpful information is being provided.

---



# Table of Contents

Hybrid system overview	①
Introduction	②
Your vehicle at a glance	③
Safety features of your vehicle	④
Features of your vehicle	⑤
Driving your vehicle	⑥
What to do in an emergency	⑦
Maintenance	⑧
Specifications & Consumer information	⑨
Abbreviation	Ⓐ
Index	Ⓛ



# Hybrid system overview

1

<b>PHEV (Plug-in Hybrid Electric Vehicle) system .....</b>	<b>1-2</b>
<b>HEV (Hybrid Electric Vehicle) system.....</b>	<b>1-3</b>
<b>Charging the plug-in hybrid vehicle .....</b>	<b>1-4</b>
• Charging information.....	1-4
• Charging time.....	1-4
• Charging types.....	1-4
• Charging status.....	1-5
• AC charging connector lock.....	1-6
• Scheduled charging.....	1-6
• Charging precautions.....	1-7
• AC charger.....	1-9
• Trickle charger (portable charging cable).....	1-11
• Charging cable storage.....	1-17
• How to disconnect charging connector in emergency.....	1-17
<b>Driving the hybrid/plug-in hybrid vehicle .....</b>	<b>1-18</b>
• Starting the vehicle.....	1-18
• Changing plug-in hybrid mode (Plug-in hybrid vehicle).....	1-18
• Special features .....	1-20
• Hybrid system gauge.....	1-21
• Warning and indicator lights.....	1-22
• LCD display messages.....	1-23
• Energy flow.....	1-29
<b>Components of the hybrid/plug-in hybrid vehicle .....</b>	<b>1-33</b>
• Plug-in hybrid vehicle components .....	1-33
• Hybrid vehicle components.....	1-36
• High voltage service interlock connector.....	1-38
• If an accident occurs.....	1-39
• When the hybrid vehicle shuts off.....	1-39

## Hybrid system overview

### PHEV (Plug-in Hybrid Electric Vehicle) system

The Kia Plug-in Hybrid Electric Vehicle (PHEV) shares the characteristics of both a conventional hybrid electric vehicle and an all-electric vehicle.

When used as a conventional hybrid electric vehicle, the HEV computer selectively operates between the engine and the electric motor or even both at the same time.

When it is operating in the electric vehicle mode, the vehicle is driven only using the electric motor over a certain distance until the hybrid battery becomes low. The driving distance in EV mode depends on customer driving style and road conditions.

Aggressive driving maneuvers may at times temporarily enable the engine to operate.

The engine power could be limited during emission reduction control period at cold engine condition.

The hybrid battery can be fully charged by connecting a plug to an external electric power source.

An engine can be turned on due to factors such as heater and a frequent operation of the accelerator pedal by a driver in CD mode.

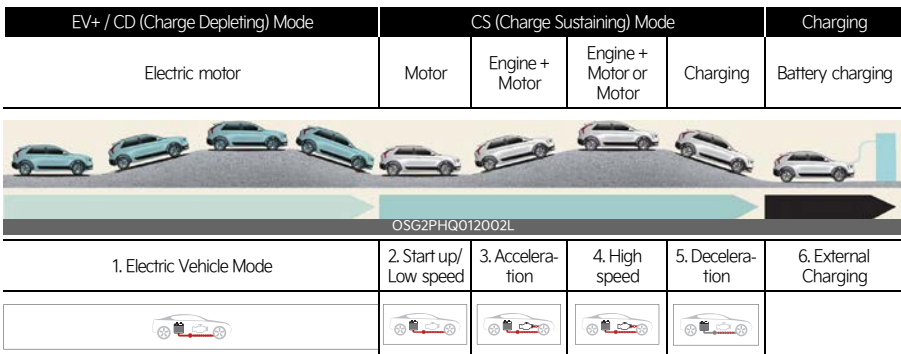



## HEV (Hybrid Electric Vehicle) system

The Kia Hybrid Electric Vehicle (HEV) uses both the gasoline engine and the electric motor for power. The electric motor is run by a high-voltage HEV battery.

Depending on the driving conditions, the HEV computer selectively operates between the engine and the electric motor or even both at the same time.

Fuel efficiency increases when the vehicle is driven by the electric motor with the HEV battery.

The HEV battery charge must be maintained, so at times the engine will come on even at idle to act as a generator. Charging also occurs when decelerating or by regenerative braking.

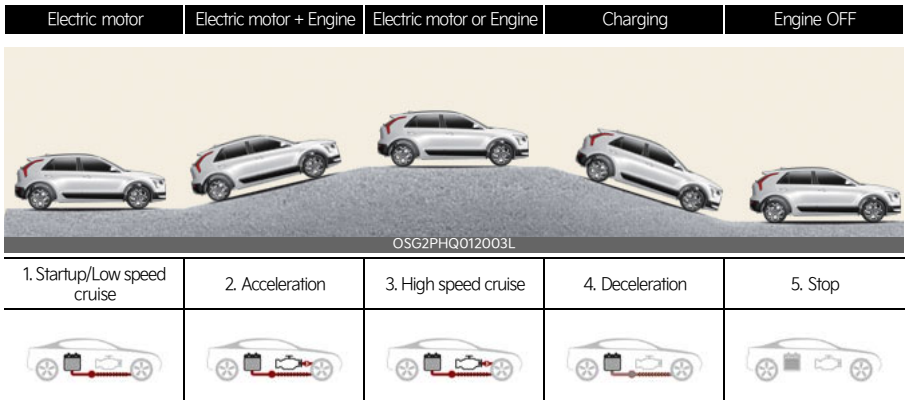

## Charging the plug-in hybrid vehicle

### Charging information





- AC Charger: The plug-in hybrid vehicle is charged by plugging into a AC charger installed in your home or a public charging station. (For further details, refer to "AC charger" on page 1-9.)
- Trickle Charger: The plug-in hybrid vehicle can be charged by using household electricity.

The electrical outlet in your home must comply with regulations and can safely accommodate the Voltage/Current (Amps)/Power (Watts) ratings specified on the trickle charge. Use only as a backup charger.

### Charging time

- AC Charger: Takes about 2 hours 45 minutes at room temperature (Can be charged to 100%). Depending on the condition and durability of the high-voltage battery, charger specifications, and ambient temperature, the time required for charging the high-voltage battery may vary.
- Trickle Charger: For charging at home. Please note that the Trickle Charger is slower than the AC Charger.

### Charging types

Category	Charging Inlet (Vehicle)	Charging Connector	Charging Outlet	Charging Method	Charging Time
AC Charger	 OSG2PHQ012021N	 OCVQ011060	 OCVQ011007L	AC charger installed in homes or public charging stations	Approximately 2 hours 45 minutes (to fully charge, 100%)
Trickle Charger	 OSG2PHQ012021N	 OCVQ011060	 OCVQ011009L	Household current	For charging at home. Please note that the Trickle Charger is slower than the AC Charger

- Depending on the condition and durability of the high voltage battery, charger specifications, and ambient temperature, the time required for charging the high voltage battery may vary.
- Actual charger image and charging method may vary in accordance with the charger manufacturer.

### **⚠ CAUTION**

- Risk of Electric Shock, Do Not Disconnect Under Load.
- Suitable For Use On A Circuit Capable Of Delivering Not More Than 5000 rms Symmetrical Amperes, 250 Volts Maximum.

## Charging status



You can check the charging status at the outside of vehicle when charging or using (it is not driving status) the high-voltage battery.

It takes about 2 ~ 3 hours or more to complete charging.

Classification		Details		Operation of charging indicator lamp	
Mode	Status			Charging inlet	Charging button
A	READY	Non-charging state	0 ~ 65 %	On (Yellow)	Off
			65 ~ 100 %	On (Green)	Off
B	Aux. Battery Saver/High voltage warning	Charging the 12V auxiliary battery / High voltage warning state		On (Red)	Off
C	Charging	Charging	0 ~ 65 %	Blinking (Yellow)	Off
			65 ~ 100 %	Blinking (Green)	Off
D	Charging complete	Charging completed (turns off in 5 seconds)	100 %	On (Green) > OFF	Off
E	Charging failed	Error while charging		Blinking (Red)	Off
F	Scheduled charging standby	Reserved charging is operating (turns OFF after 3 minutes)		Off	On
G	Error	CAN communication error status		On (Green) > On (Orange) > On (Red)	Off

## Checking charging status



You can check the charging status at the outside of vehicle when charging or using (it is not driving status) the high-voltage battery.

It takes about 2 ~ 3 hours or more to complete charging.

For more information about charging status indicator, refer to "Charging status" on page 1-5.

## AC charging connector lock

This AC charging connector lock function prevents an outsider from removing the charging connector from the charging inlet.

### Connector lock

	Always lock	Lock while charging	Do not lock Mode
Before charging	○	×	×
While charging	○	○	×
After charging	○	×	×

### Always lock

The connector locks when the charging connector is plugged into the charging inlet. The connector is locked until all doors are unlocked by the driver. This mode can be used to prevent charging cable theft.

- If the charging connector is unlocked when all doors are unlocked, but the

charging cable is not disconnected within 15 seconds, the connector will be automatically locked again.

- If the charging connector is unlocked when all doors are unlocked, but all doors are locked again, immediately, the connector will be automatically locked again.

### Lock while charging

The connector locks when charging starts. The connector unlocks when charging is complete.

### Do not lock

The locking device for charging inlet is kept unlocked regardless of charging status. The locking device is kept unlocked during charging and you can separate the connector by pressing the button of the charging connector. Please be careful about potential theft of the charging cable when selecting this mode.

### Scheduled charging (if equipped)

- You can set reserved charging using the infotainment system. Refer to the infotainment system for detailed information about setting reserved charging.
- Scheduled charging can only be done when using a AC charger or the portable charging cable (ICCB: In-Cable Control Box).
- When scheduled charging is set and the AC charger or the portable charging cable (ICCB: In-Cable Control Box) is connected for charging, the scheduled charge release button is illuminated (for 3 minutes) to indicate that scheduled charging is set.

- When scheduled charging is set, charging is not initiated immediately when the AC charger or portable charging cable (ICCB: In-Cable Control Box) is connected.
- If charging is required immediately, turn off the scheduled charge using the infotainment system or press the vehicle's scheduled charge release button (  ) more than 2 seconds.



- When the scheduled charge is set, the charge start time is calculated by itself. In some cases, charging may start immediately after connecting the charger.
- If you press the scheduled charging deactivation (  ) button to immediately charge the battery, charging must be initiated 3 minutes after the charging cable has been connected.



When you press the scheduled charging deactivation (  ) button for immediate charging, the scheduled charge setting is not completely deactivated. If you need to completely deactivate the scheduled charge set-

ting, use the infotainment system to finalize the deactivation. Refer to "AC charger" on page 1-9 or "Trickle charger (portable charging cable)" on page 1-11 for details about connecting the AC charger and the portable charger (ICCB: In-Cable Control Box).

## Charging precautions

### AC Charger



### **WARNING**

#### Fires caused by dust or water

Do not connect the charging cable connector plug to the vehicle if there is water or dust on the charging inlet. Connecting while there is water or dust on the charging cable connector and plug may cause a fire or electric shock. There may be a risk of fire and injury when using old worn out public electrical outlets.

### **WARNING**

#### Old or Worn out Electric Outlets

Do not use old or worn out electric outlets to charge your vehicle. There may be a risk of fire and injury when using old worn out public electrical outlets.

**⚠ WARNING****Interference with electronic medical devices**

When using medical electric devices such as an implantable cardiac pacemaker, make sure to ask the medical team and manufacturer whether charging your electric vehicle will impact the operation of the medical devices. In some instances, electromagnetic waves that are generated from the charger can seriously impact medical electric devices such as an implantable cardiac pacemaker.

**⚠ WARNING****Touching the charging connector**

Do not touch the charging connector, charging plug, and the charging inlet when connecting the cable to the charger and the charging inlet on the vehicle. Doing so may result in electrocution.

- Comply with the following in order to prevent electrical shock when charging:
  - Use a waterproof charger
  - Make sure to not touch the charging connector and charging plug when your hand is wet
  - Do not charge when there is lightning
  - Do not charge when the charging connector and plug is wet

**⚠ WARNING****Charging cable**

- Immediately stop charging when you find abnormal symptoms. (smell, smoke, etc.)
- Replace the charging cable if the cable coating is damaged to prevent electrical shock.
- When connecting or removing the charging cable, make sure to hold the charging connector handle and charging plug.

If you pull the cable itself (without using the handle), the internal wires may disconnect or get damaged. This may lead to electric shock or fire.

**⚠ WARNING****Cooling fan**

Do not touch the cooling fan while vehicle is charging. When the vehicle is switched OFF while charging, the cooling fan inside the motor compartment may automatically operate.

**⚠ WARNING**

Make sure to use the designated charger for charging the vehicle. Using any other charger may cause failure or lead to electric shock or fire.

- Always keep the charging connector and charging plug in clean and dry condition. Be sure to keep the charging cable in a condition where there is no water or moisture.
- Make sure to use the designated charger for charging the vehicle. Using any other charger may cause failure.

- Before charging the battery, turn the vehicle OFF.
- Be careful not to drop the charging connector. The charging connector can be damaged.
- Always inspect the charging connector terminals for damage or overheating. Do not use if damaged, as this may damage the vehicle side charge connector and is not a warrantable repair.

### AC charger

AC Charger



AC charger cable



You can charge your vehicle by plugging into a public charger at a charging station.

### How to connect AC charger



1. Depress the brake pedal and apply the parking brake.
2. Turn OFF all switches, move the shift lever or dial to P (Park), and turn OFF the vehicle.
3. Open the charging door by pressing rear center edge of the charging door.
4. Remove any dust on the charging connector and charging inlet.
5. Hold the charging connector handle.



Then, insert the charger into the charging inlet, until you hear a click sound. If it is not fully connected, a bad connection between the charging connector and the charging terminals may cause a fire.

6. Check if the charging cable connection indicator (⚡) of the high voltage battery in the instrument cluster is turned ON.

Charging does not occur when the indicator is OFF. When the charging connector is not connected properly, reconnect the charging cable to charge.

## \* NOTICE

- The charging is in progress only with the shift lever or dial is in P (Park). Charging the battery with the ENGINE START/STOP button in the ACC position is possible. However, it may discharge the 12-V battery. Thus, if possible, charge the battery with the ENGINE START/STOP button in the OFF position.
- Moving the shift lever or dial from P (Park) to R (Reverse)/N (Neutral)/D (Drive) stops the charging process. To restart the charging process, move the shift lever or dial to P (Park), press the ENGINE START/STOP button to the OFF position, and disconnect the charging cable. Then, connect the charging cable.

## Charging connector lock mode

When the charging connector is plugged into the charging inlet, the connector lock timing varies with the modes selected by the user settings menu or the infotainment screen menu.

- Always lock: The connector locks when the charging connector is plugged into the charging inlet.
- Lock while charging: The connector locks when charging starts. The connector unlocks when charging is completed.
- Do not lock: The locking device for charging inlet is kept unlocked regardless of charging status.

For more details, refer to "AC charging connector lock" on page 1-6.

## How to disconnect AC charger

1. The vehicle doors must be unlocked in order to be able to disconnect the charging connector. A lock system prevents charger cable disconnection when the vehicle's doors are locked.

## \* NOTICE

In order to disconnect the charging connector, unlock the doors to unlatch the charging connector lock system. If not, the charging connector and the vehicle's charging inlet may be damaged.

2. Hold the charging connector handle and pull it out.



To prevent charging cable theft, the charging connector cannot be disconnected from the inlet when the doors are locked.

However, if the vehicle is in the charging connector AUTO mode, the charging connector automatically unlocks from the inlet when charging is completed.

If the connector is not automatically unlocked after charging is completed in AUTO mode, the connector is unlocked when all of the doors are unlocked.

For more details, refer to "AC charging connector lock" on page 1-6.



**\* NOTICE**

When disconnecting the charging connector, do not try to disconnect it by force while not pressing the release button. This may damage the charging connector and vehicle charging inlet.

3. Close the charging door by pressing the rear center edge of the charging door.



OSG2PHQ012024N

\* The charging door does not have a locking system.

**⚠ WARNING**

Do not modify or disassemble the charging cable components. It may cause a fire or an electric shock with personal injury.

**\* NOTICE**

- If you cannot open the charging door due to freezing weather, tap lightly or remove any ice near the charging door. Do not try to forcibly open the charging door. If you open it by force, the charging door may be damaged.
- Keep the charging connector and the charging plug clean and dry. The charging cable should be also kept dry.
- Use an air gun to blow any foreign substances from the charging connector and the charging plug.

**Trickle charger (portable charging cable)**



OCVQ011020L

Trickle charger can be used if AC Charger is unavailable.

- 1 Plug and cable
- 2 Control box (ICCB)
- 3 Charging connector/cable

**How to connect portable charger (ICCB: In-Cable Control Box)**

1. Turn OFF all switches, move the shift lever or dial to P (Park), and turn OFF the vehicle.
2. Connect the plug to a household electric outlet.

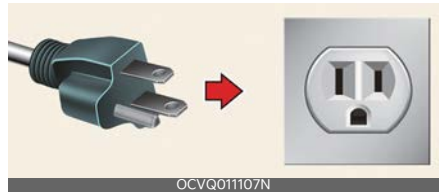

OCVQ01107N

3. Check if the power lamp (green) illuminates on the control box.



OCVQ011024

4. Depress the brake pedal and apply the parking brake.

5. Turn OFF all switches, shift to P (Park), and turn OFF the vehicle. If charging is initiated without the gear in P (Park), the charging will start after the gear is automatically shifted to P (Park).
6. Open the charging door.  
For more details, refer to "Fuel filler door" on page 5-51.
7. Open the protection caps of the charging connector and the charging plug. Check if there are any foreign substances or dust.
8. Hold the charging connector handle and connect it to the vehicle charging inlet. Push the connector all the way in. If the charging connector and charging terminal are not connected properly, this may cause a fire.
9. Charging starts automatically (charging lamp illuminates).

11. After charging has started, the estimated charging time is displayed on the instrument cluster for about 1 minute.



**A: Remaining Time**

If you open the driver seat door while charging, the estimated charging time is also displayed on the instrument cluster for about 1 minute. When scheduled charging or scheduled air conditioner/heater is set, the estimated charging time is displayed as "-".

**How to Set the Charge Level of the Portable Charger**



10. Check if the charging indicator light (⚡) of the high voltage battery in the instrument cluster is turned ON. Charging is not active when the charging indicator light (⚡) is OFF. When the charging connector is not connected properly, reconnect the charging cable to charge it again.



1. Check the rated current of the electric outlet prior to connecting the plug to the outlet.
2. Connect the plug to a household electric outlet.
3. Check the display window on the control box.
4. Press the button (1) on the front of the control box for 2 to 8 seconds to adjust the charge level. (Refer to charging cable type and example for setting the ICCB charge level.)



5. The charge level on the display window of the control box changes every time you press the button (1).
6. When setting the charge level is complete, start charging according to the portable charge procedure.

### Example for setting the ICCB charge level

The example is only for reference and may vary according to the surrounding environment.



Outlet current	ICCB charge level
14~16 A	12 A
12~13 A	10 A
10~11 A	8 A
8~9 A	6 A

### **CAUTION**

Please make sure that charge level selection matches the capacity of your circuit breaker to avoid blown fuse.

## Charging status indicator lamp for portable charger



Indicator		Details
<b>POWER</b>		On: Power on
<b>CHARGE</b>		On: Charging Blink: Current limit due to high plug temperature or high internal temperature
<b>FAULT</b>		Blink: Charging interrupted
CHARGE LEVEL	12	12 A
	10	10 A
	08	8 A
	06	6 A
	<p>The charging current changes whenever the button (1) is pressed for less than 1 sec with the charger plugged into an electrical outlet but not the vehicle.</p> <p style="text-align: center;">Control box</p>	

### Status/Diagnosis/Countermeasure



- Charging connector plugged into vehicle (POWER Green ON)
- Plug connected to an electric outlet (POWER Green ON)

### Plugged into vehicle (POWER Green ON, FAULT Red Blink)



- Diagnostic device failure
- Current leakage
- Abnormal temperature

### While charging



- Charge indicator (POWER Green ON/ CHARGE Blue ON)
- Charging current

### Leakage current failure (POWER Green ON, FAULT Red Blink)



- Disconnect and reconnect the power plug to clear the error.

### Before plugging charging connector into vehicle (POWER Green ON, FAULT Red blink)



- Abnormal temperature
- ICCB (In-Cable Control Box) failure

### Power saving mode



- Charge level indicator is turned off if there is no status change for more than 1 minute.

## How to disconnect portable charging cable (ICCB: In-Cable Control Box)

1. Before disconnecting the charging connector, make sure the doors are unlocked. When the door is locked, the charging connector lock system will not allow disconnection. To prevent charging cable theft, the charging connector cannot be disconnected from the inlet when the doors are locked. However, if the vehicle is in the charging connector AUTO mode, the charging connector automatically unlocks from the inlet when charging is completed.

### \* NOTICE

In order to disconnect the charging connector, unlock the doors to unlatch the charging connector lock system. If not, the charging connector and the vehicle's charging inlet may be damaged.

2. Hold the charging connector handle and pull it out.



3. Make sure to securely close the charging door.
4. Disconnect the plug from the household electric outlet. Do not pull the cable when disconnecting the plug.



5. Close the protective cover for the charging connector so that foreign material cannot get into the terminal.
6. Put the charging cable inside the cable compartment to protect it.

## Precautions for portable charging cable (ICCB: In-Cable Control Box)

- Use the portable charging cable that is certified by Kia.
- Do not try to repair, disassemble, or adjust the portable charging cable.
- Do not use an extension cord or adapter.
- Stop using immediately if failure warning light occurs.
- Do not touch the plug and charging connector with wet hands.
- Do not touch the terminal part of the AC charging connector and the AC charging inlet on the vehicle.
- Do not connect the charging connector to voltage that does not comply with regulations.
- Do not use the portable charging cable if it is worn out, exposed, or there exists any type of damage on the portable charging cable.
- If the ICCB case and AC charging connector is damaged, cracked, or the wires are exposed in any way, do not use the portable charging cable.
- Do not let children operate or touch the portable charging cable.
- Keep the control box free of water.

- Keep the AC charging connector or plug terminal free of foreign substances.
- Do not step on the cable or cord. Do not pull the cable or cord and do not twist or bend it.
- Do not charge when there is lightning.
- Do not drop the control box or place a heavy object on the control box.
- Do not place an object that can generate high temperatures near the charger when charging.
- Charging with the worn out or damaged household electric outlet can result in a risk of electric shock. If you are in doubt to the household electric outlet condition, have it checked by a licensed electrician.
- Stop using the portable charging cable immediately if the household electric outlet or any components is overheated or you notice burnt odors.

### Actions to be taken for electric vehicle charging issues

When you cannot charge the high voltage battery after connecting the charger, check the following:

1. Check the charging settings for the vehicle.  
(e.g. when scheduled charging is set, charging is not initiated immediately when the AC charger or portable charger is connected.)
2. Check the operation status of the AC charger, portable charger.  
(Status of portable charger)  
\* Actual method for indicating the charging status may vary in accordance with the charger manufacturer.
3. When the vehicle does not charge and a warning message appears on the

instrument cluster, check the corresponding message.

4. If the vehicle is properly charged when charged with another normally working charger, contact the charger manufacturer.
5. If the vehicle does not charge when charged with another normally working charger, have your vehicle inspected by an authorized Kia dealer.

### Charging cable storage



We recommend that the trickle charger cable should be put in the storage box after use.

### How to disconnect charging connector in emergency



If the charging connector does not disconnect due to battery discharge and/or failure of the electric system, open the luggage board (1), remove the storage box and slightly pull the emergency cable (2). The charging connector will then disconnect.

## Driving the hybrid/plug-in hybrid vehicle

### Starting the vehicle

#### Vehicles with smart key system

1. Carry the smart key or leave it inside the vehicle.
2. Make sure the parking brake is firmly applied.
3. Place the shift lever or dial in P (Park). With the shift lever or dial in N (Neutral), you cannot start the vehicle.
4. Depress the brake pedal.
5. Press the ENGINE START/STOP button. If the hybrid system starts, the **READY** indicator will come on.

Whether the engine is cold or warm, it should be started without depressing the accelerator.

After following the start procedures, **READY** indicator on the instrument cluster will turn on. For more details, please refer to "Starting the vehicle" on page 1-18.

#### Economical and safe operation of Hybrid system

- Drive smoothly. Accelerate at a moderate rate and maintain a steady cruising speed. Do not make "jackrabbit" starts. Do not race between stoplights.  
Avoid heavy traffic whenever possible. Always maintain a safe distance from other vehicles so you can avoid unnecessary braking. This also reduces brake wear out.
- The regenerative brake generates energy when the vehicle decelerates.
- When the hybrid battery power is low, the hybrid system automatically recharges the hybrid battery.

- When the engine is running with the shift lever or dial in N (Neutral), the hybrid system cannot generate electricity. The hybrid battery cannot recharge with the shift lever or dial in N (Neutral).

#### \* NOTICE

In the hybrid system, the engine automatically runs and stops. When the hybrid system operates, the **READY** indicator is illuminated.

In the following situation, the engine may operate automatically.

- When the engine is ready to run.
- When the hybrid battery is being charged.
- Depending on the temperature condition of the hybrid battery.

### Changing plug-in hybrid mode (Plug-in hybrid vehicle)

#### EV button



Whenever you press the [EV] button, Plug-in hybrid system drive mode will be changed in sequential as:

Automatic (AUTO) mode - Hybrid (CS) mode - Electric (CD) mode.

And you press and hold the EV button will be changed to EV+ mode.

Each time the mode is changed a corresponding LED is displayed on the instrument cluster as follows.



### Automatic (AUTO) mode

Type A



Type B



### Electric (CD) mode

Type A



Type B

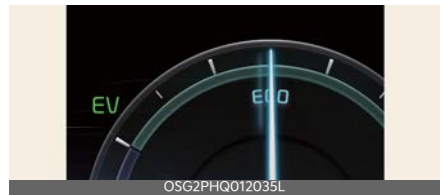

### Hybrid (CS) mode

Type A



Type B

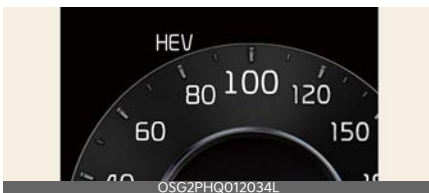

### EV + mode

Type A



Type B



### Plug-in hybrid mode indicator

- CD (Charge Depleting, Electric) mode: The high-voltage (hybrid) battery is used to drive the vehicle.
- AUTO mode: CD mode and CS mode are selected automatically depending on road conditions.

- CS (Charge Sustaining, Hybrid) mode: The high-voltage (hybrid) battery and gasoline engine is used to drive the vehicle.
- EV+ mode: The high voltage battery is only used for vehicle driving. (except completely press the accelerator pedal)

### Special features

Hybrid vehicles sound different than gasoline engine vehicles. When the hybrid system operates, you may hear a sound from the hybrid battery system behind the rear seat. If you apply the accelerator pedal rapidly, you may hear an unconventional sound. When you apply the brake pedal, you may hear a sound from the regenerative brake system. When the hybrid system is turned off or on, you may hear a sound in the engine compartment. If you depress the brake pedal repeatedly when the hybrid system is turned on, you may hear a sound in the engine compartment. None of these sounds indicate a problem. These are normal characteristics of hybrid vehicles.

It is a normal condition if you hear a motor sound in the engine compartment in any of the following situations:

- The brake pedal is released after turning off the hybrid system.
- The brake pedal is applied when the hybrid system is turned off.
- When the driver door is opened.

When the hybrid system is turned ON, the gasoline engine may run or may not. In this situation, you may feel a vibration. This does not indicate a malfunction. When the **READY** indicator illuminates, the hybrid system is ready to begin driving. Even if the engine is off, you can

operate the vehicle as long as the **READY** indicator is illuminated.

### \* NOTICE

The hybrid system contains many electronic components. High voltage components, such as cables and other parts, may emit electromagnetic waves. Even when the electromagnetic cover blocks electromagnetic emissions, electromagnetic waves may have an effect on electronic devices. When your vehicle is not used for a long period of time, the hybrid system will discharge. You need to drive the vehicle several times a month. We recommend driving at least for 1 hour or 16 km (10 miles). When the hybrid battery is discharged, or when it is impossible to jump start the vehicle, contact your authorized Kia dealer.

When you start the hybrid system with the shift lever or dial in P (Parking), the **READY** indicator illuminates on the instrument cluster. The driver can drive the vehicle, even when the gasoline engine is off.

### ⚠ WARNING

When you leave the vehicle, you should turn OFF the hybrid system or locate the shift lever or dial in P (Park). When you depress the accelerator pedal by mistake, or when the shift lever or dial is not in P (Park), the vehicle will abruptly move, possibly resulting in serious injury or death.

## Virtual Engine Sound System (VESS)

Virtual Engine Sound System generates engine sound for pedestrians to hear vehicle sound because there is limited sound while motor power is used.

- If the vehicle is moving at low speed, the VESS will operate.
- When the gear is shifted to R (Reverse), an additional warning sound will be heard.

## What does regenerative braking do?

It uses an electric motor when decelerating and when braking and transforms kinetic energy to electrical energy in order to charge the high voltage battery.

## Battery

- The vehicle is composed of a high voltage battery that drives the motor and air conditioner, and an integrated 12V lead battery with the HEV battery that drives the lamps, wipers, and audio system.
- The integrated 12V battery is automatically charged when the vehicle is in the ready (**READY**) mode.

## Hybrid system gauge

### Power gauge

Type A



Type B

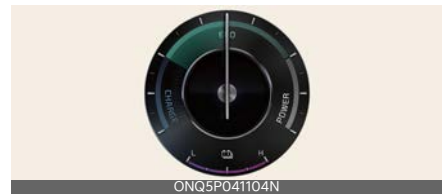

The hybrid system gauge indicates whether the current driving condition is fuel efficient or not.

- **CHARGE:**  
Shows that the energy made by the vehicle is being converted to electrical energy. (Regenerated energy)
- **ECO:**  
Shows that the vehicle is being driven in an Eco-friendly manner.
- **POWER:**  
Shows that the vehicle is exceeding the Eco-friendly range.

## Hybrid battery SOC (State of Charge) gauge

Type A

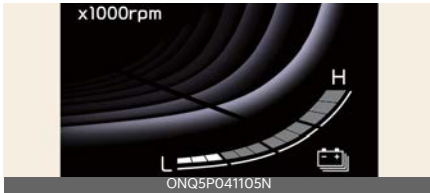

Type B



This gauge indicates the remaining hybrid battery power. If the SOC is near the "L (Low)" level, the vehicle automatically operates the engine to charge the battery.

However, if the Service Indicator (🔧) and Malfunction Indicator Lamp (MIL) (🚗) turn on when the SOC gauge is near the "L (Low)" level, have your vehicle inspected by an authorized Kia dealer.

### Warning and indicator lights

#### Ready indicator READY

##### This indicator illuminates:

When the vehicle is ready to be driven.

- ON: Normal driving is possible.
- OFF: Normal driving is not possible, or a problem has occurred.
- Blinking: Emergency driving.

When the ready indicator goes OFF or blinks, there is a problem with the sys-

tem. If this occurs, have your vehicle inspected by an authorized Kia dealer.

#### Service warning light 🛠️

##### This warning light illuminates:

- When you set the ENGINE START/STOP button to the ON position.
  - The service warning light illuminates for approximately 3 seconds and then turns off when all checks have been performed.
- When there is a problem with the hybrid vehicle control system or hardware.

When the warning light illuminates while driving, or does not go OFF after starting the vehicle, have your vehicle inspected by an authorized Kia dealer.

#### EV mode indicator EV

##### This indicator illuminates:

When the vehicle is driven by the electric motor.

- "EV" indicator ON: Vehicle is driven using the electric motor or the gasoline engine is stopped.
- "EV" indicator OFF: Vehicle is driven using the gasoline engine.

#### Regenerative brake warning light

⚠️ (red color) ⚠️ (yellow color)

##### This warning light illuminates:

When the regenerative brake does not operate and the brake does not perform well. This causes the brake warning light (red) and regenerative brake warning light (yellow) to appear simultaneously.

If this occurs, drive safely and have your vehicle inspected by an authorized Kia dealer. The operation of the brake pedal may be more difficult than normal and the braking distance may increase.

### Charging cable connection indicator (Plug-in hybrid vehicle)

This indicator illuminates in red when the charging cable is connected.

## LCD display messages

### Ready to drive

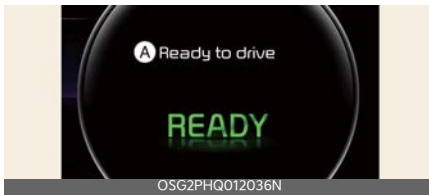

#### A: Ready to drive

This message is displayed when the vehicle is ready to be driven.

### Check regenerative brakes



#### A: Check regenerative brakes

This message is displayed when the brake performance is low or the regenerative brake does not work properly due to a failure in the brake system.

If this occurs, it may take longer for the brake pedal to operate and the braking distance may become longer.

### Stop vehicle and check regenerative brakes

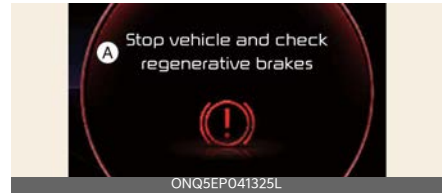

#### A: Stop vehicle and check regenerative brakes

This message is displayed when a failure occurs in the brake system.

If this occurs, park the vehicle in a safe location tow your vehicle to the nearest authorized Kia dealer and have the vehicle inspected.

### Check Hybrid system

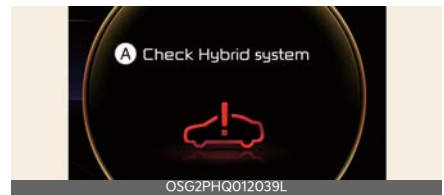

#### A: Check Hybrid system

This message is displayed when there is a problem with the hybrid control system. Refrain from driving when the warning message is displayed.

If this occurs, have your vehicle inspected by an authorized Kia dealer.

### Check Hybrid system. Stop safely



**A: Check Hybrid system. Stop safely**

This message is displayed when there is a problem with the hybrid control system. The **READY** indicator will blink and a warning chime will sound until the problem is solved. Refrain from driving when the warning message is displayed. If this occurs, have your vehicle inspected by an authorized Kia dealer.

### Stop vehicle and check power supply



**A: Stop vehicle and check power supply**

This message is displayed when a failure occurs in the power supply system. If this occurs, park the vehicle in a safe location and tow your vehicle to the nearest authorized Kia dealer and have the vehicle inspected.

### Check Hybrid system. Do not start engine

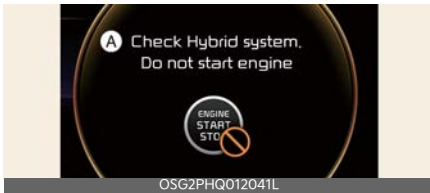

**A: Check Hybrid system. Do not start engine**

This message is displayed when the hybrid battery power (SOC) level is low. A warning chime will sound until the problem is solved. Refrain from driving when the warning message is displayed. If this occurs, park the vehicle in a safe location and tow your vehicle to the nearest authorized Kia dealer and have the vehicle inspected.

### Check Virtual Engine Sound System

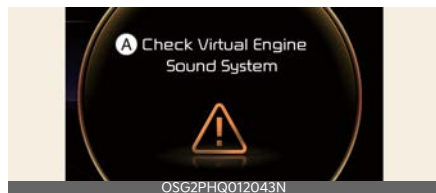

**A: Check Virtual Engine Sound System**

This message is displayed when there is a problem with the Virtual Engine Sound System (VESS). If this occurs, have your vehicle inspected by an authorized Kia dealer.

## Refill inverter coolant



### A: Refill inverter coolant

This message is displayed when the inverter coolant is nearly empty. You should refill the inverter coolant.

## Park with engine On to charge battery

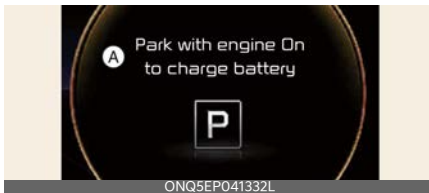

### A: Park with engine On to charge battery

This message is displayed when the hybrid battery power (SOC) level is low. If this occurs, park the vehicle in a safe location and wait until the hybrid battery is charged.

## Start engine to avoid battery discharge

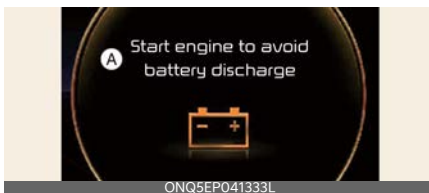

### A: Start engine to avoid battery discharge

This message is displayed to inform the driver the 12V battery may be discharged if the ENGINE START/STOP button is in ON position (without the **READY** indicator ON).

Set the vehicle to the ready (**READY**) mode to prevent the 12V battery from being discharged.

## Coasting guide



### A: Coast

A chime will sound and the coasting guide indicator will be displayed to inform the driver when to take the foot off the accelerator by anticipating a decelerating event\* based on the analysis of driving routes and road conditions stored in the navigation system. It encourages the driver to remove the foot from the pedal and allow coasting down the road with EV motor only. This helps preventing unnecessary fuel consumption and increases fuel efficiency.

\* Example of a deceleration event is going down an extended hill, slowing down approaching a toll booth, and approaching reduced speed zones.

- User settings

Press the ENGINE START/STOP button and put the shift lever or dial in P (Park). In the User Settings Mode, select Driver assistance, Coasting Guide, and then On to turn on the system. Cancel the selection of coasting guide to turn off the system. For the

explanation of the system, press and hold the [OK] button.

• Operation conditions

To activate the system, take the following procedures. Enter your destination information on the navigation and select the driving route. Select the ECO mode in the Integrated Driving Control System. Then, satisfy the following:

- The driving speed should be between 30 km/h (19 mph) and 160 km/h (99 mph).

\* The operating speed may vary due to difference between instrument cluster and navigation effected by tire inflation level.

**CD (Charge Depleting, Electric) mode (Plug-in hybrid vehicle)**



**A: Electric mode**

The high-voltage (hybrid) battery is used to drive the vehicle.

**EV+ (Electric +) mode (Plug-in hybrid vehicle)**



**A: EV + Mode**

The high-voltage (hybrid) battery is only used to drive the vehicle. (Except completely depressing the accelerator pedal).

**AUTO (Automatic) mode (Plug-in hybrid vehicle)**



**A: Automatic mode**

The drive mode will be automatically selected from either Electric (CD) mode or Hybrid (CS) mode by the system according to the driving condition.

**CS (Charge Sustaining, Hybrid) mode (Plug-in hybrid vehicle)**



**A: Hybrid mode**

The high-voltage (hybrid) battery and gasoline engine is used to drive the vehicle.



## Remaining charge time (Plug-in hybrid vehicle)



### A: Remaining Time

The message is displayed to notify the remaining time to fully charge the battery.

## Charging stopped. Check the AC charger (Plug-in hybrid vehicle)

This message is displayed when the charging failed by external charger error.

The purpose of this message is to let you know the error has occurred in the charger itself, not in the vehicle.

## Charging stopped. Check the cable connection (Plug-in hybrid vehicle)

This message is displayed when charging is stopped because the charging connector is not correctly connected to the charging inlet. If this occurs, separate the charging connector and reconnect it and check whether there is any problem (external damage, foreign substances, etc.) with the charging connector and charging inlet. If the same problem occurs when charging the vehicle with a replaced charging cable or genuine Kia portable charger, have the vehicle inspected by a professional workshop. Have your vehicle inspected by an authorized Kia dealer.

## Low/High System Temp. Maintaining Hybrid mode (Plug-in hybrid vehicle)

This message is displayed when the temperature of the high-voltage (hybrid) battery is too low or too high.

This warning message is to protect the battery and the hybrid system.

## Low/High System Temp. Switching to Hybrid mode (Plug-in hybrid vehicle)

This message is displayed when the temperature of the high-voltage (hybrid) battery is too low or high. This warning message is to protect the battery and the hybrid system.

## Switching to Hybrid mode to allow heating (Plug-in hybrid vehicle)

- When the outdoor temperature is lower than  $-13\text{ }^{\circ}\text{C}$  ( $9\text{ }^{\circ}\text{F}$ ) and the coolant temperature is lower than  $40\text{ }^{\circ}\text{C}$  ( $104\text{ }^{\circ}\text{F}$ ), you turn the climate control On for heating, the above message will be displayed in the cluster. Then, the vehicle will automatically switch to HEV mode and EV mode will not be activated (although EV button is pressed)
- When the outdoor temperature is higher than  $-10\text{ }^{\circ}\text{C}$  ( $14\text{ }^{\circ}\text{F}$ ), or the coolant temperature is higher than  $80\text{ }^{\circ}\text{C}$  ( $176\text{ }^{\circ}\text{F}$ ) or you turn the climate control Off, the vehicle will automatically return to EV mode.

### **Wait until fuel door unlocks (Plug-in hybrid vehicle)**

The message is displayed when you attempt to unlock the fuel filler door with the fuel tank pressurized. Wait until the fuel tank is depressurized.

#### **\* NOTICE**

- It may take up to 20 seconds to unlock fuel filler door.
- If the fuel filler door does not open because ice has formed around it, tap lightly or push on the door to break the ice and release the door.
- Do not pry on the door. If necessary, spray around the door with an approved de-icer fluid (do not use radiator anti-freeze) or move the vehicle to a warm place and allow the ice to melt.

### **Fuel door unlocked (Plug-in hybrid vehicle)**

This message is displayed when the fuel filler door is unlocked.

Also means "Ready to refuel".

Please press the rear center edge of fuel filler door to open.

### **Check fuel door (Plug-in hybrid vehicle)**

This message is displayed when the fuel filler door is open while driving or an abnormality has occurred.

### **Charging door open (Plug-in hybrid vehicle)**

This message indicates that the charging door is open while in driving ready state to encourage you to inspect and close the door.

(Driving with the charging door open may result in moisture inflow or damage. This message is used to prevent such occurrences.)

### **Unplug vehicle to start (Plug-in hybrid vehicle)**

The message is displayed when you start the engine without unplugging the charging cable. Unplug the charging cable, and then start the vehicle.

### **Maintaining Hybrid mode to continue heating (Plug-in hybrid vehicle)**

A message is displayed when heating is in operation and the HEV mode is maintained to meet the heating operating conditions when attempting to switch to EV mode by pressing the EV button.

### **EV/HEV modes (Plug-in hybrid vehicle)**

A corresponding message is displayed when a mode is selected by pressing the EV button.

## PHEV infotainment system (Plug-in hybrid vehicle)

Press [PHEV] on the [Home screen].



### 1 PHEV

The Plug-in Hybrid menu consists of five sections: [EV range], [Energy information], [Charge management], [ECO driving], [Energy flow].

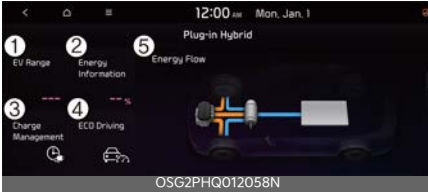

### 1 EV range

### 2 Energy information

### 3 Charge management

### 4 ECO driving

### 5 Energy flow

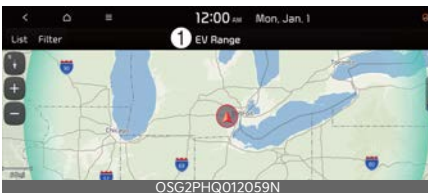

### 1 EV range

## \* INFORMATION

The infotainment system may change after software updates. For more information, refer to the user's manual provided in the infotainment system and the quick reference guide.

## Energy flow

The hybrid system informs the drivers its energy flow in various operating modes. While driving, the current energy flow is specified in 11 modes.

## Vehicle stop



### A: Idle Mode

The vehicle is stopped. (No energy flow)

## EV propulsion



### A: Electric Mode

Only the motor power is used to drive the vehicle. (Battery → Wheel)

### Power assist



**A: Hybrid Mode**  
 Both the motor and the engine power are used to drive the vehicle.  
 (Battery & Engine → Wheel)

### Regeneration



**A: Charging**  
 The high-voltage battery is charged up by the regenerative brake system.  
 (Wheel → Battery)

### Engine only propulsion



**A: Engine Mode**  
 Only the engine power is used to drive the vehicle.  
 (Engine → Wheel)

### Engine brake



**A: Engine Braking**  
 The engine braking is used to decelerate the vehicle.  
 (Wheel → Engine)

### Engine generation



**A: Charging**  
 When the vehicle is stopped, the high-voltage battery is charged up by the engine.  
 (Engine → Battery)

### Power reserve



**A: Charging**  
 The engine is simultaneously used to drive the vehicle and to charge up the high-voltage battery.  
 (Engine → Wheel & Battery)

### Engine generation/motor drive



#### A: Charging

The engine charges up the high-voltage battery. The motor power is used to drive the vehicle.  
(Engine → Battery → Wheel)

### Engine generation/regeneration

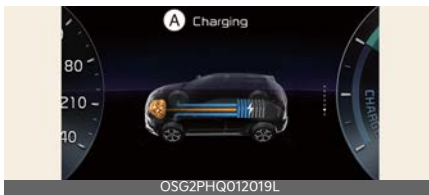

#### A: Charging

The engine and regenerative brake system charges up the high-voltage battery.  
(Engine & Wheel → Battery)

### Engine brake/regeneration

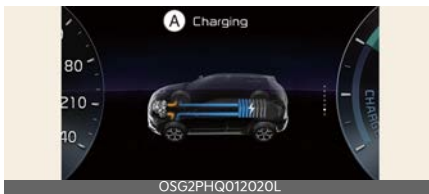

#### A: Charging

The engine braking is simultaneously used to decelerate the vehicle and to charge up the high-voltage battery.  
(Wheel → Engine & Battery)

### Start engine to avoid battery discharge

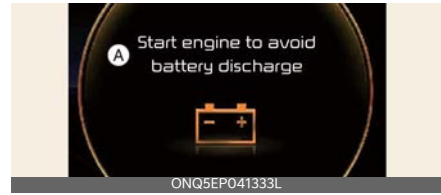

#### A: Start engine to avoid battery discharge

If the engine is not turned on with the ENGINE START/STOP button in ACC or ON for a while, the battery can be discharged. Please turn on the engine to prevent 12V battery from discharge.

1

## Aux. Battery Saver+

The Aux. Battery Saver+ is a function that monitors the charging status of the 12V auxiliary battery. If the auxiliary battery level is low, the main high voltage battery charges the auxiliary battery.

### \* NOTICE

The Aux. Battery Saver+ function will be ON when the vehicle is delivered.

## Mode

- Cycle Mode: When the vehicle is OFF with all doors, hood and liftgate closed, the Aux. Battery Saver+ periodically activates according to the auxiliary battery status.
- Automatic Mode: When the ENGINE START/STOP button is in the ON position with the charging connector plugged in, the function activates according to the auxiliary battery status to prevent over-discharge of the auxiliary battery.

### ⚠ CAUTION

- The Aux. Battery Saver+ activates for a maximum of 20 minutes. If the Aux. Battery Saver+ function activates more than 10 times consecutively, in the Automatic Mode the function will stop activating, judging that there is a problem with the auxiliary battery. In this case, drive the vehicle for some period of time. The function will start activating if the auxiliary battery returns to normal.
- The Aux. Battery Saver+ function cannot prevent battery discharge if the auxiliary battery is damaged, worn out, used as a power supply or unauthorized electronic devices are used.

## System setting

The driver can activate the Aux. Battery Saver+ function by placing the ENGINE START/STOP button to the ON position.

### ⚠ WARNING

When the function is activated the charging indicator lamp will quickly blink and high voltage electricity will be flowing in the vehicle. Do not touch the high voltage electric wire (orange), connector, and all electric components and devices. This may cause electric shock and lead to injuries. Also, do not modify your vehicle in any way. This may affect your vehicle performance and lead to an accident.

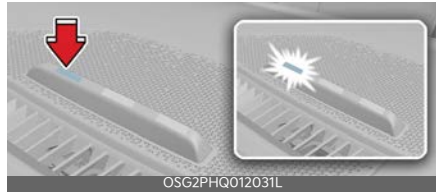

## Components of the hybrid/plug-in hybrid vehicle

### Plug-in hybrid vehicle components

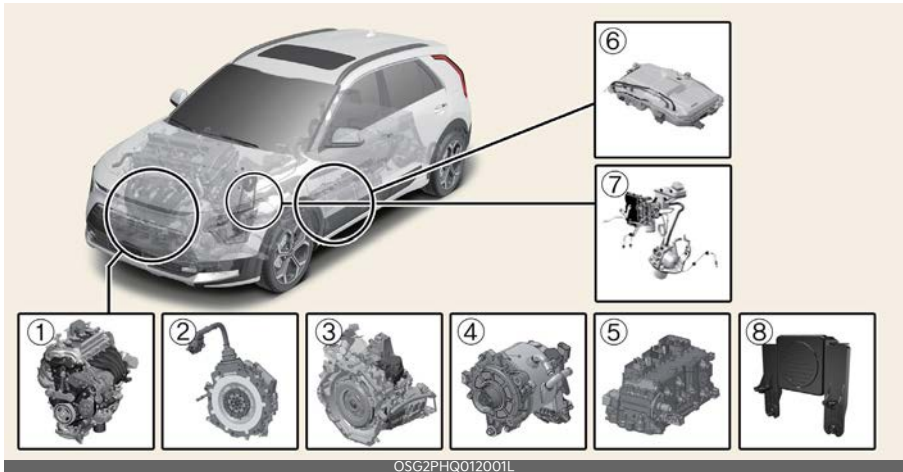

\* The actual shape may differ from the illustration.

- 1 Engine: 1.6L
- 2 Motor: 62kW
- 3 Transmission: 6DCT
- 4 Hybrid starter generator (HSG)
- 5 HPCU (Hybrid Power Control Unit)
- 6 High voltage battery system
- 7 Regenerative brake system
- 8 Virtual Engine Sound System (VESS)

The Hybrid battery uses high voltage to operate the electric motor and other components. High voltage is dangerous if touched.

Your vehicle is equipped with orange colored insulation and covers over the high voltage components to protect people from electric shock. High voltage warning labels are attached to some system components as additional warnings. Have your vehicle serviced by a professional workshop. Have your vehicle inspected by an authorized Kia dealer.

HPCU (Hybrid Power Control Unit) \*1

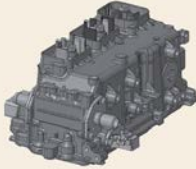

OSG2HQ011019

High voltage battery system \*2



OSG2PHQ012053L

\* 1: Located in the engine compartment

\* 2: Located underfloor

**⚠ WARNING**

**High voltage components**

Never touch orange colored or high voltage labeled components, including wires, cables, and connections. When the insulators or covers are damaged or removed, severe injury or death from electrocution may occur.

**⚠ WARNING**

**Avoid Touching Hybrid Power Control Unit**

While replacing the fuses in the engine compartment, never touch the HPCU. The HPCU carries high voltage. Touching the HPCU may result in electrocution, serious injury, or death.

**⚠ CAUTION**

**High Voltage Battery Damage**

When loading your vehicle, be careful of transporting items in a manner that could damage the high voltage battery. Do not store items on top of the high voltage battery or overload the trunk area. Such actions may ultimately damage the high voltage battery unit.

**⚠ WARNING**

In the hybrid system, the hybrid battery uses high voltage to operate the motor and other components. This high voltage hybrid battery system can be very dangerous.

Never touch the hybrid system. When you touch the hybrid battery system, serious injury or death may occur.

**⚠ CAUTION**

Be careful when loading flammable liquid in the passenger compartment. It could cause operational and safety degradation if the liquid leaks and flows in the high voltage battery.

Drive motor \*3



OSG2HQ011017

\* 3: Located in the engine compartment



**⚠ WARNING****Battery electrolyte**

As with all batteries, avoid fluid contact with the hybrid battery. If the battery is damaged and if electrolyte comes in contact with your body, clothes or eyes, immediately flush with a large quantity of fresh water.

**⚠ WARNING****After market battery charger**

Do not use an after-market battery charger to charge the hybrid battery. Doing so may result in death or serious injury.

**⚠ WARNING****High waters**

- Avoid high waters as this may result in your vehicle becoming saturated with water and could compromise the high voltage components.
- Do not touch the any of the high voltage components within your vehicle if your vehicle has been submerged in water equal to half of the vehicle height. Touching high voltage components once submerged in water could result in severe burns or electric shock that could result in death or serious injury.

**⚠ CAUTION****Carrying liquids in liftgate**

Do not load large amounts of water in open containers into the vehicle. If the water spills onto the HEV battery, it may cause a short and damage the battery.

**⚠ CAUTION****Cleaning engine**

When you clean the engine compartment, do not wash using water. Water may cause electric arcing to occur and damage electronic parts and components.

**⚠ WARNING****Exposure to high voltage**

- High voltage in the hybrid battery system is very dangerous and can cause severe burns and electric shock. This may result in serious injury or death.
- For your safety, never touch, replace, dismantle or remove any portion of the hybrid battery system including components, cables and connectors.

**⚠ WARNING****Use of water or liquids**

If water or liquids come into contact with the hybrid system components, and you are also in contact with the water, severe injury or death due to electrocution may occur.

**⚠ WARNING****Hot components**

When the hybrid battery system operates, the HEV battery system can be hot. Heat burns may result from touching even insulated components of the HEV system.

**⚠ CAUTION**

**Prolonged parking**

Prolonged parking might cause battery discharge and operation failure due to natural discharge. Driving the vehicle approximately once every 2 months, more than 15 km (9 miles) is recommended. The battery will be charged automatically when driving the vehicle.

**Hybrid vehicle components**

**High voltage battery system**

HPCU (Hybrid Power Control Unit) \*1



High voltage battery system \*2



\* 1: Located in the engine compartment

\* 2: Located under the 2nd row seats

**⚠ WARNING**

Never touch orange colored or high voltage labeled components, including wires, cables, and connections. When the insulators or covers are damaged or removed, severe injury or death from electrocution may occur.

**⚠ WARNING**

While replacing the fuses in the engine compartment, never touch the HPCU. The HPCU carries high voltage. Touching the HPCU may result in electrocution, serious injury, or death.

**⚠ WARNING**

In the hybrid system, the hybrid battery uses high voltage to operate the motor and other components. This high voltage hybrid battery system can be very dangerous.

Never touch the hybrid system. When you touch the hybrid battery system, serious injury or death may occur.

**⚠ CAUTION**

Be careful when loading flammable liquid in the luggage compartment. It could cause operational and safety degradation if the liquid leaks and flows in the high voltage battery.

Drive motor \*3



\* 3: Located in the engine compartment

**⚠ WARNING**

- Do not disassemble the high voltage motor connector. The high voltage motor connector may contain residual high voltage. Coming in contact with high voltage may result in death or serious injury.

- Your vehicle's hybrid system should only be inspected or repaired by an authorized Kia dealer.

**⚠ WARNING**

- Do not disassemble or assemble the high voltage battery system. Doing so may result in electric shock, causing death or serious injury.
- If you disassemble or assemble hybrid system components improperly, it may damage the performance and reliability of your vehicle.
- If electrolyte comes in contact with your body, clothes or eyes, immediately flush with a large quantity of fresh tap water. Have your eyes examined by a doctor as soon as possible.

**⚠ WARNING**

Never assemble or disassemble the high voltage battery system.

- If you assemble or disassemble the high voltage battery system, the durability and performance of the vehicle may be damaged.
- When you want to check the high voltage battery system, have the vehicle inspected by an authorized Kia dealer.
- Do not touch the high voltage battery and high voltage cable connected to motor (orange color). Severe burns and electric shock may occur. For your safety, do not touch the cover of electronic components and electronic cable. Do not remove the cover of electronic components and electronic cable. In particular, never touch the high voltage battery system when the

hybrid system in operation. It may result in death or serious injury.

**⚠ WARNING**

- Never use the package modules (high voltage battery, inverter and converter) for any other purpose.
- Do not use an unauthorized battery charger to charge the high voltage battery. Doing so may result in death or serious injury.
- Never locate the high voltage system near or in a fire.
- Never drill into or strike the package module. Otherwise, it may be damaged. An electric shock may occur, resulting in serious injury or death.

**\* NOTICE**

- When the vehicle is paint baked, do not bake over 30 minutes in 70°C (158 °F) or 20 minutes in 80 °C (176 °F) degree.
- Do not wash the engine compartment, using water. Water may cause an electric shock and damage the electronic components.

**⚠ WARNING**

This hybrid vehicle uses the hybrid battery system inverter and converter to generate high voltage. High voltage in the hybrid battery system is very dangerous and may cause severe burns and electric shock. This may result in serious injury or death.

- For your safety, never touch, replace, disassemble or remove the hybrid battery system including components, cables and connectors. Severe burns or electric shock may result in serious

injury or death when you fail to follow this warning.

- When the hybrid battery system operates, the hybrid battery system can be hot. Always be careful because burns or electric shock may be caused by high voltage.
- Do not spill liquid on the HPCU, HSG, motor and fuses. If the hybrid system components come in contact with liquid, it may result in electric shock.

### Hybrid battery cooling duct (Hybrid vehicle)

Under the rear seats



The hybrid battery cooling duct is located under the rear seats. The cooling duct cools down the hybrid battery. When the hybrid battery cooling duct is blocked, the hybrid battery may be overheated.

Clean the cooling duct for the hybrid battery with a dry cloth on a regular basis.

### ⚠ WARNING

#### Air Intake

- Blocking the air intake behind the rear seats may damage the HEV battery.
- Do not allow any water into the air intake even when cleaning. If any water enters the air intake, the Hybrid battery may cause an electric shock which can cause serious injury or death due to electrocution.

### ⚠ WARNING

#### Interference with electronic medical devices

- Electromagnetic waves that are generated from the charger can impact medical electric devices such as an implantable cardiac pacemaker. When using such medical electric devices, ask your medical professional and the device manufacturer whether charging your electric vehicle will impact the operation of the medical electric devices.

### High voltage service interlock connector

### ⚠ DANGER

Hybrid



Plug-in Hybrid

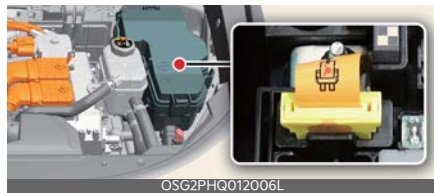

In case of emergency, pull the yellow lever in the service interlock connector to isolate the high voltage of the battery. Service interlock connector is not completely removed.

**⚠ WARNING**

Never disconnect the service interlock connector except in an emergency situation. Serious problems may occur, such as the vehicle will not start.

**If an accident occurs****⚠ WARNING**

- For your safety, do not touch the high voltage cables, connectors and package modules. High voltage components are orange in color.
- Exposed cables or wires may be visible inside or outside of the vehicle. Never touch the wires or cables, because an electrical shock, an injury, or a death may occur.
- Any gas or electrolyte leakage from your vehicle is not only poisonous but also flammable. Upon witnessing one of those, open the windows, and remain a safe distance from the vehicle out of the road.  
Immediately call an emergency services or contact an authorized Kia dealer and advise them that a hybrid vehicle is involved.
- When the vehicle is severely damaged, remain a safe distance of 15 m (49 ft.) or more between your vehicle and other vehicles/ flammables.

**\* NOTICE**

If a fire occurs:

- If a small scale fire occurs, use a fire extinguisher (ABC, BC) that is meant for electrical fires.  
If it is impossible to extinguish the fire in the early stage, remain a safe distance from the vehicle and immediately call your local fire emergency

responders. Also, advise them that a hybrid vehicle is involved.

If the fire spreads to the high voltage battery, large amount of water is needed to put out the fire.

Using small amount of water or fire extinguishers not meant for electrical fires could cause serious injury or death from electrical shocks.

- Upon witnessing any sparks, gases, flames, or fuel leakage of your vehicle, immediately call emergency services or contact an authorized Kia dealer. Also, advise them that a hybrid vehicle is involved.

**⚠ WARNING**

When a submersion in water occurs:

When your vehicle is flooded in water, a high-voltage battery may cause shock or fires. Thus, turn the hybrid system OFF, take the key in your possession and escape to a safe place. Never attempt physical contact with your flooded vehicle.

Immediately contact an authorized Kia dealer and advise them that a hybrid vehicle is involved.

**When the hybrid vehicle shuts off**

When the high voltage battery or 12 volt battery is discharged, or when the fuel tank is empty, the hybrid system may not operate while driving. When the Hybrid system does not operate, do the followings:

1. Gradually reduce the vehicle speed.  
Pull over your vehicle off the road in a safe area.
2. Locate the shift lever or dial in P (Park).
3. Turn ON the hazard warning flashers.

4. Turn OFF the vehicle, and try to start the hybrid system again, while depressing the brake pedal and turning on the ENGINE START/STOP button.
5. When the hybrid system still does not operate, refer to "Emergency starting" on page 7-5.

Before jump-starting the vehicle, check the fuel level and the exact procedure to jump start. When the fuel level is low, do not attempt to drive the vehicle only with the battery power. The high voltage battery may be discharged, and the hybrid system will turn OFF.

### **WARNING**

#### **Vehicle accident**

Never touch electric wires or cable. If exposed electric wires or cables are visible inside or outside of your vehicle, an electric shock may occur.

---

### **WARNING**

#### **Putting out fire**

Never use a small quantity of water to put out a fire in your vehicle. If a fire occurs, evacuate the car immediately and contact the fire department.

---

<b>Fuel requirements .....</b>	<b>2-2</b>
<b>Vehicle modifications.....</b>	<b>2-5</b>
<b>Vehicle break-in process .....</b>	<b>2-5</b>
<b>Risk of burns when parking or stopping vehicle .....</b>	<b>2-6</b>
• Vehicle handling instructions.....	2-6
• Open Source Software Notice.....	2-6
<b>Vehicle data collection and Event Data Recorders.....</b>	<b>2-7</b>
<b>HEV/PHEV powertrain .....</b>	<b>2-8</b>

## Introduction

### Fuel requirements

Your new vehicle is designed to use only unleaded fuel having a pump octane number  $((R+M)/2)$  of 87 (Research Octane Number 91) or higher. (Do not use methanol blended fuels.)

Your new vehicle is designed to obtain maximum performance with UNLEADED FUEL, as well as minimize exhaust emissions and spark plug fouling.

Never add any fuel system cleaning agents to the fuel tank other than what has been specified. (Consult an authorized Kia dealer for details.)

- Tighten the cap until it clicks one time, otherwise the Check Engine light will appear.

#### WARNING

#### Refueling

- Do not "top off" after the nozzle automatically shuts off. Attempts to force more fuel into the tank can cause fuel overflow onto you and the ground, causing a risk of fire.
- Always check that the fuel cap is installed securely to prevent fuel spillage, especially in the event of an accident.

### Gasoline containing alcohol and methanol

Gasohol, a mixture of gasoline and ethanol (also known as grain alcohol), and gasoline or gasohol containing methanol (also known as wood alcohol) are being marketed along with or instead of leaded or unleaded gasoline.

Do not use gasohol containing more than 15% ethanol, and do not use gaso-

line or gasohol containing any methanol. Either of these fuels may cause drivability problems and damage to the fuel system, engine control system and emission control system.

Discontinue using gasohol of any kind if drivability problems occur.

Vehicle damage or drivability problems may not be covered by the manufacturer's warranty if they result from the use of:

1. Gasoline or gasohol containing methanol.
2. Leaded fuel or leaded gasohol.
3. Gasohol containing more than 15% ethanol.

"E85" fuel is an alternative fuel comprised of 85% ethanol and 15% gasoline, and is manufactured exclusively for use in Flexible Fuel Vehicles. "E85" is not compatible with your vehicle. Use of "E85" may result in poor engine performance and damage to your vehicle's engine and fuel system. Kia recommends that customers do not use fuel with an ethanol content exceeding 15%.

#### NOTICE

Your New Vehicle Limited Warranty does not cover damage to the fuel system or any performance problems caused by the use of "E85" fuel.

#### NOTICE

Never use any fuel containing methanol. Discontinue use of any methanol containing products which may inhibit proper drivability.



## Other fuels

Using fuels that contain Silicone (Si), MMT (Methylcyclopentadienyl Manganese Tricarbonyl), Manganese (Mn) contained fuel, and other metallic additives, may cause vehicle and engine damage or cause misfiring, poor acceleration, engine stalling, catalyst melting, clogging, abnormal corrosion, life cycle reduction, etc.

Also, the Malfunction Indicator Lamp (MIL) may appear.

### \* NOTICE

Damage to the fuel system or performance problems caused by the use of these other fuels may not be covered by your New Vehicle Limited Warranty.

(Methylcyclopentadienyl Manganese Tricarbonyl). Kia does not recommend the use of gasoline containing MMT. This type of fuel can reduce vehicle performance and affect your emission control system. The Malfunction Indicator Lamp (MIL) on the cluster may come on.

2

## Use of MTBE

Kia recommends avoiding fuels containing MTBE (Methyl Tertiary Butyl Ether) over 15.0% vol. (Oxygen Content 2.7% weight) in your vehicle.

Fuel containing MTBE over 15.0% vol. (Oxygen Content 2.7% weight) may reduce vehicle performance and produce vapor lock or hard starting.

### \* NOTICE

Your New Vehicle Limited Warranty may not cover damage to the fuel system and any performance problems that are caused by the use of fuels containing methanol or fuels containing MTBE (Methyl Tertiary Butyl Ether) over 15.0% vol. (Oxygen Content 2.7% weight.)

## Gasoline containing MMT

Some gasoline contains harmful manganese-based fuel additives Such as MMT

## Do not use methanol

Fuels containing methanol (wood alcohol) should not be used in your vehicle. This type of fuel can reduce vehicle performance and damage components of the fuel system, engine control system and emission control system.

## Fuel Additives

Kia recommends that you use good quality gasolines treated with detergent additives such as TOP TIER Detergent Gasoline, which help prevent deposit formation in the engine. These gasolines will help the engine run cleaner and enhance performance of the emission control system.

For more information on TOP TIER Detergent Gasoline, please go to the website ([www.toptiergas.com](http://www.toptiergas.com)) For customers who do not use TOP TIER Detergent Gasoline regularly, and have problems starting or the engine does not run smoothly, additives that you can buy separately may be added to the gasoline.

If TOP TIER Detergent Gasoline is not available, one bottle of additive should be added to the fuel tank at every 13,000 km (8,000 miles) or every engine oil change is recommended. Additives are available from your authorized Kia dealer along with information on how to use them. Do not mix other additives.

## Operation in foreign countries

If you are going to drive your vehicle in another country, be sure to:

- Observe all regulations regarding registration and insurance.

- Determine that acceptable fuel is available.

## Vehicle modifications

This vehicle should not be modified. Modification of your vehicle could affect its performance, safety or durability and may even violate governmental safety and emissions regulations.

### \* NOTICE

Damage or performance problems resulting from any modification may not be covered under warranty.

### ⚠ CAUTION

If you use unauthorized electronic devices, it may cause the vehicle to operate abnormally, wire damage, battery discharge and fire. For your safety, do not use unauthorized electronic devices.

## Vehicle break-in process

By following a few simple precautions for the first 1,000 km (600 miles) you may add to the performance, economy and life of your vehicle.

- Do not race the engine.
- While driving, keep your engine speed (rpm, or revolutions per minute) between 2,000 rpm and 4,000 rpm.
- Do not maintain a single engine speed for long periods of time, either fast or slow. Varying engine speeds is needed to properly break-in the engine.
- Avoid hard stops, except in emergencies, to allow the brakes to seat properly.
- Don't tow a trailer during the first 2,000 km (1,200 miles) of operation.
- Fuel economy and engine performance may vary depending on vehicle break-in process and be stabilized after 6,000 km (4,000 miles). New engines may consume more oil during the vehicle break-in period.

## Risk of burns when parking or stopping vehicle

- Do not park or stop the vehicle near flammable items such as leaves, paper, oil, and tire. Such items placed near the exhaust system can become a fire hazard.
- When an engine idles at a high speed with the rear side of the vehicle touching the wall, heat of the exhaust gas can cause discoloration or fire. Keep enough space between the rear part of the vehicle and the wall.
- Be sure not to touch the exhaust/catalytic systems while engine is running or right after the engine is turned off. There is a risk of burns since the systems are extremely hot.

## Vehicle handling instructions

As with other vehicles of this type, failure to operate this vehicle correctly may result in loss of control, an accident or vehicle rollover.

Specific design characteristics (higher ground clearance, track, etc.) give this vehicle a higher center of gravity than other types of vehicles. In other words they are not designed for cornering at the same speeds as conventional 2-wheel drive vehicles.

Avoid sharp turns or abrupt maneuvers. Again, failure to operate this vehicle correctly may result in loss of control, an accident or vehicle rollover.

**Be sure to read the "Reducing the risk of a rollover" on page 6-185.**

## Open Source Software Notice

This vehicle contains software with open source licenses.

Open source software information including the source code, copyright

notices and referred license terms may be obtained on the website <http://worldwide.kia.com/int/opensource>

Kia Corporation will provide the open source code to you in storage medium such as CD-ROM for minimum charge covering the cost of performing source distribution upon email request to [opensource@kia.com](mailto:opensource@kia.com)

within a period of 3 years from the date of product purchase.

## Vehicle data collection and Event Data Recorders

This vehicle is equipped with an Event Data Recorder (EDR). The main purpose of an EDR is to record, in certain crash or near crash-like situations, such as an air bag deployment or hitting a road obstacle, data that will assist in understanding how a vehicle's systems performed. The EDR is designed to record data related to vehicle dynamics and safety systems for a short period of time, typically 30 seconds or less. The EDR in this vehicle is designed to record such data as:

- How various systems in your vehicle were operating;
- Whether or not the driver and passenger safety belts were buckled/ fastened;
- How far (if at all) the driver was depressing the accelerator and/or brake pedal; and,
- How fast the vehicle was traveling.

These data can help provide a better understanding of the circumstances in which crashes and injuries occur.

**NOTE:** EDR data are recorded by your vehicle only if a non-trivial crash situation occurs; no data are recorded by the EDR under normal driving conditions and no personal data (e.g., name, gender, age, and crash location) are recorded. However, other parties, such as law enforcement, could combine the EDR data with the type of personally identifying data routinely acquired during a crash investigation.

To read data recorded by an EDR, special equipment is required, and access to the vehicle or the EDR is needed. In addition to the vehicle

manufacturer, other parties, such as law enforcement, that have the special equipment, can read the information if they have access to the vehicle or the EDR.

## HEV/PHEV powertrain

By following a few simple precautions for the first 1,000 km (600 miles) you may increase the performance economy and life of your vehicle.

- Do not race the engine.
- Avoid hard stops, except in emergencies, to allow the brakes to seat properly.

# Your vehicle at a glance **3**

Exterior overview .....	3-2
Interior overview .....	3-4
Instrument panel overview .....	3-6
Engine compartment.....	3-8

# Your vehicle at a glance

## Exterior overview

Front view



OSG2PH012001L

\* The actual shape may differ from the illustration.

- |                                  |                    |
|----------------------------------|--------------------|
| 1. Hood                          | 5-49               |
| 2. Head lamp                     | 5-113, 8-55        |
| 3. Wheel and tire                | 8-31, 9-5          |
| 4. Outside rear view mirror      | 5-72               |
| 5. Sunroof                       | 5-56               |
| 6. Front windshield wiper blades | 5-119, 8-25        |
| 7. Windows                       | 5-45               |
| 8. Front ultrasonic sensor       | 6-157              |
| 9. Front radar                   | 6-68, 6-118, 6-172 |
| 10. Front view camera            | 6-58               |
| 11. Front fog lamp               | 5-116, 8-55        |



- |                                               |       |
|-----------------------------------------------|-------|
| 12.Roof rack                                  | 5-154 |
| 13.Charging door (For plug-in hybrid vehicle) | 1-4   |

## Rear view



OSG2PH012002L

\* The actual shape may differ from the illustration.

- |                           |             |
|---------------------------|-------------|
| 1. Doors                  | 5-16        |
| 2. Fuel filler door       | 5-51        |
| 3. Rear combination lamp  | 5-114, 8-55 |
| 4. High mounted stop lamp | 5-114, 8-55 |
| 5. Liftgate               | 5-35        |
| 6. Antenna                | 5-156       |
| 7. Wide-rear view camera  | 6-146       |
| 8. Rear ultrasonic sensor | 6-157       |
| 9. Rear wiper             | 5-119, 8-25 |
| 10.Backup lamp            | 5-114, 8-55 |

## Interior overview



OSG2PH012003N\_2

\* The actual features in your vehicle may not necessarily be available due to the selected options or regions.

1. Inside door handle	5-18
2. Seat position memory system	5-33
3. Outside rearview mirror folding switch	5-72
4. Outside rearview mirror control switch	5-72
5. Central door lock/unlock switch	5-19
6. Power window switches (Front)	5-46
7. Power window switches (Rear)	5-46
8. Power window lock button	5-48
9. Steering wheel tilt/telescopic lever	5-60
10. Steering wheel	5-59
11. Instrument panel illumination control switch	5-77
12. Power liftgate open/close button	5-39
13. 12V battery reset button	7-5

**Your vehicle at a glance**

**Interior overview**

14.ESC OFF button	6-48
15.Hood release lever	5-49
16.Instrument panel fuse	8-44
17.Seat	4-5
18.shift lever or dial	6-22, 6-22
19.Brake pedal	6-38
20.Fuel door open button	5-51

## Instrument panel overview

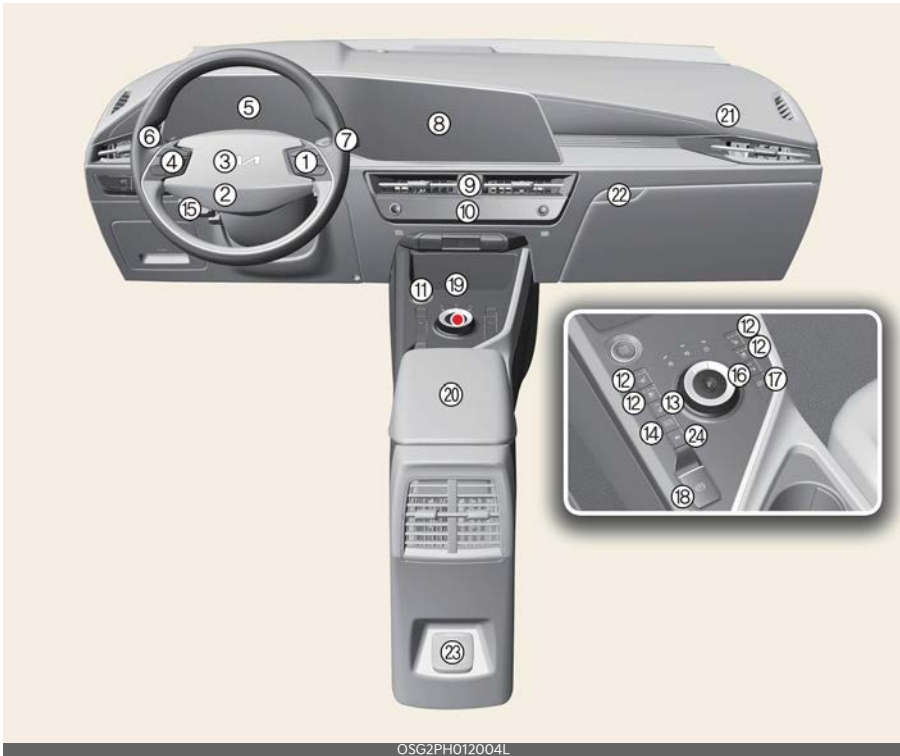

\* The actual features in your vehicle may not necessarily be available due to the selected options or regions.

- |                                                       |       |
|-------------------------------------------------------|-------|
| 1. Audio remote control button                        | 5-59  |
| 2. Driver's front air bag                             | 4-43  |
| 3. Horn                                               | 5-62  |
| 4. Driving Assist button                              | 6-118 |
| 5. Instrument cluster                                 | 5-75  |
| 6. Light control/turn signals lever                   | 5-113 |
| 7. Wiper and washer control lever                     | 5-119 |
| 8. Infotainment system                                | 5-155 |
| 9. Hazard warning flasher switch                      | 7-3   |
| 10. Infotainment/climate switchable controller        | 5-155 |
| 11. ENGINE START/STOP button                          | 6-11  |
| 12. Front seat warmer and air ventilation seat button | 5-143 |
| 13. Heated steering wheel                             | 5-61  |

14.AUTO HOLD button	6-44
15.Drive mode integrated control system	6-55
16.Parking Safety button	6-157, 6-160, 6-166
17.Parking/View button	6-146, 6-172
18.EPB button	6-40
19.Wireless smartphone charging system	5-147
20.Center console storage box	5-141
21.Passenger's front air bag	4-43
22.Glove box	5-141
23.115V Inverter	5-146
24.EV Button	1-18

# Engine compartment

Smartstream G1.6 GDi HEV

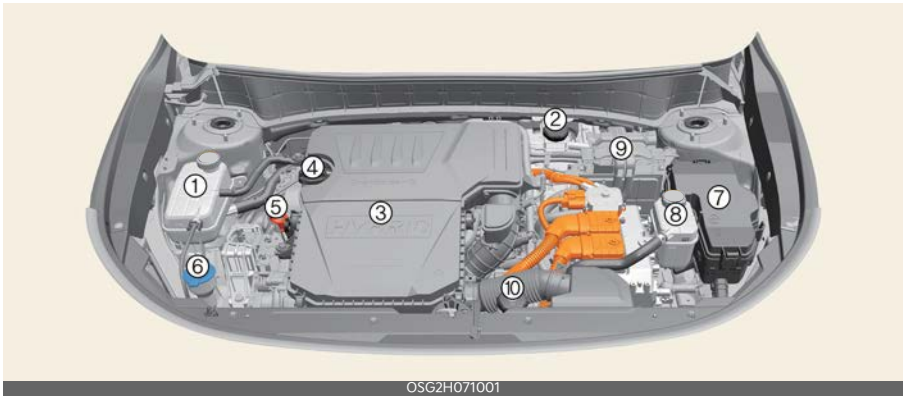

Smartstream G1.6 GDi PHEV

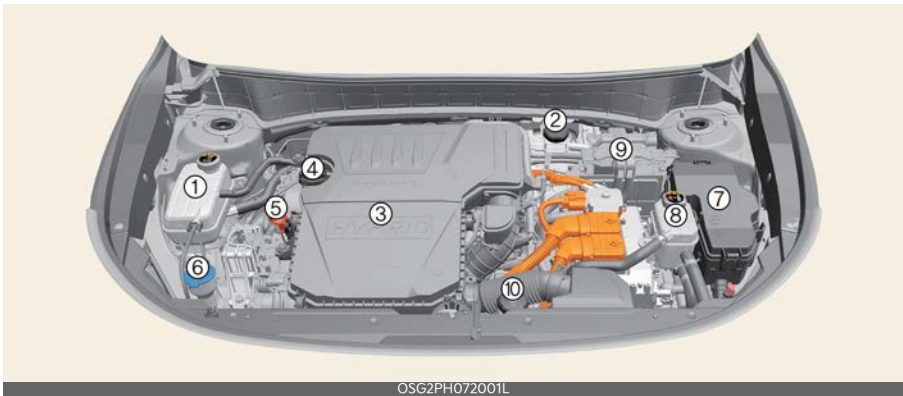

\* The actual engine room in the vehicle may differ from the illustration.

- |                                      |      |
|--------------------------------------|------|
| 1. Engine coolant reservoir          | 8-17 |
| 2. Brake fluid reservoir             | 8-21 |
| 3. Air cleaner                       | 8-13 |
| 4. Engine oil filler cap             | 8-15 |
| 5. Engine oil dipstick               | 8-15 |
| 6. Windshield washer fluid reservoir | 8-23 |
| 7. Fuse box                          | 8-42 |
| 8. Inverter coolant reservoir        | 8-18 |
| 9. Electric Control Unit (ECU)       | 7-5  |
| 10. Engine actuator reservoir tank   | 8-22 |

<b>Important safety precautions .....</b>	<b>4-3</b>
<b>Seat .....</b>	<b>4-5</b>
• Feature of Seat Leather.....	4-7
• Infotainment system (if equipped).....	4-8
• Front seat adjustment for manual seat.....	4-8
• Front seat adjustment for power seat .....	4-9
• Headrest for front seat .....	4-11
• Seatback pocket.....	4-13
• Headrest for rear seat.....	4-14
• Armrest.....	4-14
• Folding the rear seat.....	4-14
<b>Seat belts .....</b>	<b>4-17</b>
• Seat belt restraint system.....	4-17
• Seat belt warning .....	4-18
• Seat belt - Driver's 3-point system with emergency locking retractor .....	4-19
• Seat belts - Front passenger and rear seat 3-point system with combination locking retractor.....	4-20
• Pre-tensioner seat belt .....	4-22
• Seat belt precautions.....	4-23
• Care of seat belts .....	4-24
<b>Child Restraint System (CRS).....</b>	<b>4-25</b>
• Children always in the rear.....	4-25
• Selecting a CRS.....	4-26
• Installing a CRS .....	4-28
<b>Air bag - advanced Supplemental Restraint System .....</b>	<b>4-33</b>
• How does the air bag system operate?.....	4-34
• Do not install a child restraint on the front passenger's seat.....	4-35
• Air bag warning light .....	4-35
• Supplemental Restraint System (SRS) components and functions.....	4-36

# 4 Safety features of your vehicle

- Occupant Detection System (ODS).....4-38
- Driver's and passenger's front air bag .....4-43
- Side air bag..... 4-45
- Curtain air bag ..... 4-46
- Air bag collision sensors ..... 4-48
- Why didn't my air bag go off in a collision? (Inflation and non-inflation conditions of the air bag)..... 4-49
- Supplemental Restraint System (SRS) care ..... 4-51
- Additional safety precautions.....4-52
- Adding equipment to or modifying your air bag-equipped vehicle.....4-53
- Air bag warning labels.....4-53



## Safety features of your vehicle

For the safety of the driver and vehicle passengers, you should become familiar with the vehicle's safety features.

### Important safety precautions

You will find many safety precautions and recommendations throughout this section, and throughout this manual.

The safety precautions in this section are among the most important.

### Always wear your seat belt

A seat belt is your best protection in all types of accidents. Air bags are designed to supplement seat belts, not replace them. So even though your vehicle is equipped with air bags, ALWAYS fasten your seat belt and make sure all of your passengers have properly fastened their seat belts or restraints before placing vehicle in motion.

### Restrain all children

All children under age 13 should ride in your vehicle properly restrained in a rear seat, not the front seat. Infants and small children should be restrained in an appropriate child restraint. Larger children should use a booster seat with the lap/shoulder belt until they can use the seat belt properly without a booster seat.

### Air bag hazards

While air bags can save lives, they can also cause serious or fatal injuries to occupants who sit too close to them, or who are not properly restrained. Infants, young children, and shorter adults are at the greatest risk of being injured by an

inflating air bag. Follow all instructions and warnings in this manual.

### Driver distraction

Driver distraction presents a serious and potentially deadly danger, especially for inexperienced drivers. Safety should be the first concern when behind the wheel and drivers need to be aware of the wide array of potential distractions, such as drowsiness, reaching for objects, eating, personal grooming, other passengers, and using cellular phones.

Drivers can become distracted when they take their eyes and attention off the road or their hands off the wheel to focus on activities other than driving. To reduce your risk of distraction or getting into an accident:

- ALWAYS set up your mobile devices (i.e., MP3 players, phones, navigation units, etc.) when your vehicle is parked or safely stopped.
- ONLY use your mobile device when allowed by laws and when conditions permit safe use. NEVER text or email while driving. Most countries have laws prohibiting drivers from texting. Some countries and cities also prohibit drivers from using handheld phones.
- NEVER let the use of a mobile device distract you from driving. You have a responsibility to your passengers and others on the road to always drive safely, with your hands on the wheel as well as your eyes and attention on the road.

## **Control your speed**

Excessive speed is a major factor in crash injuries and deaths. Generally, the higher the speed, the greater the risk, but serious injuries can also occur at lower speeds. Never drive faster than is safe for current driving conditions, regardless of the maximum speed posted.

## **Keep your vehicle in safe condition**

Having a tire blowout or a mechanical failure can be extremely hazardous. To reduce the possibility of such problems, check your tire pressures and conditions frequently, and perform all regularly scheduled maintenance.

## Seat



4

### Front seat

1. Sliding: Forward and Backward
2. Reclining: Back angle
3. Seat cushion height
4. Seat cushion tilt
5. Lumbar support
6. Driver position memory system
7. Headrest

### Rear seat

8. Seat back folding
9. Armrest
10. Headrest
11. Seatback folding

**⚠ WARNING**

**Loose objects**

Loose objects in the driver's foot area could interfere with the operation of the foot pedals, possibly causing an accident. Do not place anything under the front seats.

**⚠ WARNING**

**Uprighting seat**

Do not press the release lever on a manual seatback without holding and controlling the seatback. The seatback will spring upright, possibly impacting you or other passengers.

**⚠ WARNING**

**Driver responsibility for passengers**



The driver must advise the passengers to keep the seatback in an upright position whenever the vehicle is in motion. If a seat is reclined during an accident, the restraint system's ability to restrain the passenger will be greatly reduced.

**⚠ WARNING**

**Seat cushion**

Occupants should never sit on aftermarket seat cushions or sitting cushions. The Passenger Occupant Detection System may not operate properly, or the passenger's hips may slide under the lap

portion of the seat belt during an accident or a sudden stop.

**⚠ WARNING**

**Driver's seat**

- Never attempt to adjust the seat while the vehicle is moving. This could result in loss of control of your vehicle.
- Do not allow anything to interfere with the normal position of the seatback. For example, storing items against the seatback could result in serious or fatal injury in a sudden stop or collision.
- Sit as far back as possible from the steering wheel while still maintaining comfortable control of the your vehicle. A distance of at least 25 cm (10 inches) from your chest to the steering wheel is recommended. Failure to do so can result in air bag inflation injuries to the driver.

**⚠ WARNING**

**Rear seatbacks**

Always lock the rear seatback before driving. Failure to do so could result in passengers or objects being thrown forward, injuring vehicle occupants.

**⚠ WARNING**

**Unexpected Seat Movement**

After adjusting a manual seat, always check that it is locked by shifting your weight to the front and to the back. Sudden or unexpected movement of the driver's seat could cause you to lose control of the vehicle.

**⚠ WARNING****Seat adjustment**

- Do not adjust the seat while wearing seat belts. Moving the seat forward will cause strong pressure on the abdomen.
- Do not place your hand near the seat bottom or seat track while adjusting the seat. Your hand could get caught in the seat mechanism.

**⚠ WARNING****Luggage and Cargo**

Do not stock pile or stack luggage or cargo higher than the seatback in the cargo area. In an accident the cargo could strike and injure a passenger. If objects are large, heavy or must be piled, they must be secured in the cargo area.

**⚠ WARNING****Cargo Area**

Do not allow passengers to ride in the cargo area under any circumstance. The cargo area is solely for the purpose of transporting luggage or cargo.

**⚠ WARNING****Small Objects**

Use extreme caution when picking up small objects trapped under the seats or between the seat and the center console. Your hands might be cut or injured by the sharp edges of the seats mechanism.

**⚠ CAUTION****Precautions with seat covers**

Use caution when working on the seat cover. A short circuit or disconnection may occur, which could lead to noise, damage the ventilation system.

**⚠ WARNING****Seat short circuit risk**

Be aware of wires or air vents when placing a seat cover or covering the seat with plastic cover. A short circuit may occur, which could lead to fire.

**Feature of Seat Leather (if equipped)**

- Our car seats are upholstered with a combination of artificial and genuine leather. The genuine leather is made from the outer skin of an animal, which goes through a special process to be available for use. Since it is a natural substance, each part differs in thickness or density. Also, wrinkles could appear depending on the temperature and humidity.
- The seat cover is made of stretchable material to improve comfort of passengers.
- The parts contacting the body are curved and the side supporting area is high which provides driving comfort and stability.
- Wrinkles may appear naturally from usage. It is not a fault of the product.

**⚠ CAUTION**

- Belts with metallic accessories, zippers or keys inside the back pocket may damage the seat fabric.

- Make sure not to wet the seat. It may change the leather.
- Jeans or clothes which could bleach may contaminate the surface of the seat covering fabric.

**\* NOTICE**

Wrinkles or abrasions may appear naturally from usage. It is not a fault of product. Wrinkles or abrasions are not covered by warranty.

**Infotainment system (if equipped)**



**A: Vehicle settings**

- 1 Seat**
- 2 Seat change alert**
- 3 Seating Easy Access**

Select **Setting** → **Vehicle** → **Seat** from the Settings menu in the infotainment system screen, you may use various convenience functions.

- **Seat Position Change Alert:** When the seat position changes, details of the change are shown with a seat image.
- **Seating Easy Access**
  - **Seat Slide Easy Access (Normal/Extended/Off)** the seat automatically moves when the driver enters or leaves the vehicle may be selected.

The information provided may differ according to which functions are applicable to your vehicle.

**\* INFORMATION**

The infotainment system may change after software updates. For more information, refer to the user's manual provided in the infotainment system and the quick reference guide.

**Front seat adjustment for manual seat**

The front seat can be adjusted by using the control levers located on the outside of the seat cushion.

**Moving forward and backward**



Adjust the seat before driving, and make sure the seat is locked securely by trying to move forward and backward without using the lever. If the seat moves, it is not locked properly.

To move the seat forward or backward:

1. Pull the seat slide adjustment lever up and hold it.
2. Slide the seat to the position you desire.
3. Release the lever and make sure the seat is locked in place.

## Reclining seatback



To recline the seatback:

1. Lean forward slightly and lift up the seatback recline lever.
2. Carefully lean back on the seat and adjust the seatback of the seat to the position you desire.
3. Release the lever and make sure the seatback is locked in place. (The lever MUST return to its original position for the seatback to lock.)

### **⚠ WARNING**

#### Reclining seatback

Sitting in a reclined position when the vehicle is in motion can be dangerous. Even when buckled up, the protections of your restraint system (seat belts and/or air bags) are greatly reduced by reclining your seatback.

Seat belts must be snug against your hips and chest to work properly. When the seatback is reclined, the shoulder belt cannot do its job because it will not be snug against your chest. Instead, it will be in front of you. During an accident, you could be thrown into the seat belt, causing neck or other injuries.

The more the seatback is reclined, the greater chance the passenger's hips will slide under the lap belt or the passen-

ger's neck will strike or become entangled in the shoulder belt.

## Changing seat cushion height (if equipped)



To change the height of the seat cushion, push the lever upwards or downwards.

- To lower the seat cushion, push down the lever several times.
- To raise the seat cushion, pull up the lever several times.

## Front seat adjustment for power seat (if equipped)

The front seat can be adjusted by using the control switches located on the outside of the seat cushion.

Before driving, adjust the seat to the proper position so you can easily control the steering wheel, pedals and switches on the instrument panel.

### **⚠ WARNING**

#### Unattended children

Never leave children unattended in a vehicle. Children might operate features of the vehicle that could injure them.

**⚠ CAUTION**

**Power seating adjustments**

- The power seating controls function by electronic motor. Excessive operation may cause damage to the electrical equipment.
- Do not operate two or more power seat control switches at the same time. Doing so may damage the power seat motor or electrical components.

**Moving forward and backward**



To move the seat forward or backward:

1. Push the control switch forward or backward to move the seat to the desired position.
2. Release the switch once the seat reaches the desired position.

**Reclining seatback**



To recline the seatback:

1. Push the control switch forward or backward to move the seatback to the desired angle
2. Release the switch once the seat reaches the desired position.

**Changing seat cushion tilt and height (if equipped)**

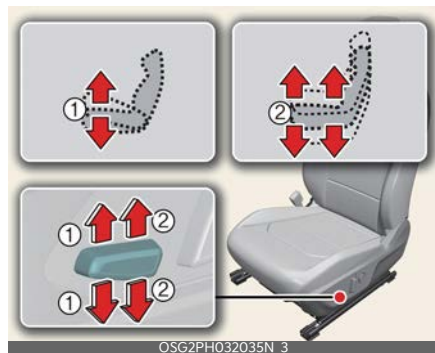

To change the height of the seat:

1. Pull the front portion (1) of the control switch up to raise or press down to lower the front part of the seat cushion.
2. Pull the rear portion (2) of the control switch up to raise or press down to lower the back part of the seat cushion.



3. Release the switch once the seat reaches the desired position.

### Adjusting lumbar support for driver's seat (if equipped)



The lumbar support can be adjusted by pressing the lumbar support switch on the side of the seat.

1. Press the front portion (1) of the switch to increase support or the rear portion (2) of the switch to decrease support.
2. Release the switch once it reaches the desired position.

### Headrest for front seat

The driver's and front passenger's seats are equipped with a headrest for the occupant's safety and comfort.



The headrest not only provides comfort for the driver and front passenger, but also helps protect the head and neck in the event of a rear collision.

For maximum effectiveness in case of an accident, the headrest should be

adjusted so the middle of the headrest is as high as the center of gravity of an occupant's head. Generally, the center of gravity of most people's head is similar with the height of the top of their eyes. Also, adjust the headrest as close to your head as possible. For this reason, the use of a cushion that holds the body away from the seatback is not recommended.

### ⚠ WARNING

#### Headrest removal/adjustment

- Do not operate the vehicle with the headrests removed. Headrests can provide critical neck and head support in a crash.
- Do not adjust the headrest height while the vehicle is in motion. Driver may lose control of the vehicle.

### ⚠ CAUTION

Excessive pulling or pushing may damage the headrest.

### Adjusting the height up and down



To raise the headrest:

- Pull it up to the desired position (1).
- To lower the headrest, push and hold the release button (2) on the headrest support.
- Lower the headrest to the desired position (3).

**\* NOTICE**

If you recline the seatback towards the front with the headrest and seat cushion raised, the headrest may come in contact with the sun visor or other parts of the vehicle.



**Forward and backward adjustment (for front seats)**



The headrest may be adjusted forward to 3 different positions by pulling the headrest forward to the desired position. To adjust the headrest to it's furthest backwards position, pull it fully forward to the farthest position and release it. Adjust the headrest so that it properly supports the head and neck.

**Removing headrest**

Type A

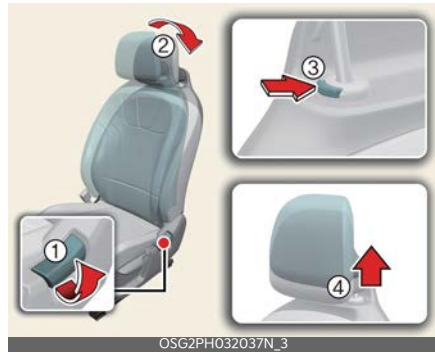

Type B



To remove the headrest:

1. Recline the seatback (2) with the recline lever or switch (1).
2. Raise headrest as far as it can go.
3. Press the headrest release button (3) while pulling the headrest up (4).

**⚠ WARNING**

**Removing headrest**

NEVER allow anyone to ride in a seat with the headrest removed or reversed. Headrests can provide critical neck and head support in a crash.

## Reinstalling headrest

Type A

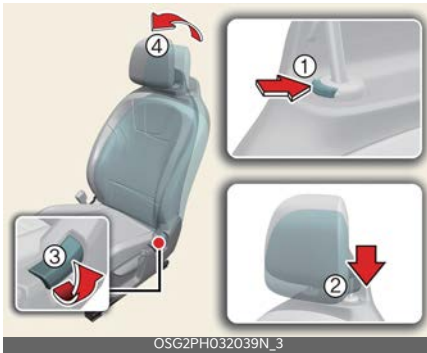

Type B



To reinstall the headrest:

1. Put the headrest poles (2) into the holes while pressing the release button (1).
2. Recline the seatback (4) with the recline lever or switch (3).
3. Adjust the headrest to the appropriate height.

### **⚠ WARNING**

#### **Headrest Reinstallation**

To reduce the risk of injury to the head or neck, always make sure the headrest is locked into position and adjusted properly after reinstalling.

## Seatback pocket (if equipped)

There is a pocket (1) in the front seat back for storing simple books or atlases, and USB charger (2) (if equipped) for rear passengers.



### **⚠ WARNING**

#### **Seatback pockets**

Do not put heavy or sharp objects in the seatback pockets. In an accident they could come loose from the pocket and injure vehicle occupants.

## Headrest for rear seat

The rear seat is equipped with headrests in all the seating positions for the occupant's safety and comfort.



The headrest not only provides comfort for passengers, but also helps protect the head and neck in the event of a collision.

To maximize the effectiveness in case of accidents, the headrest should be adjusted so the middle of the headrest is as high as the center of gravity of an occupant's head. Generally, the center of gravity of most people's heads is similar with the height as the top of their eyes.

Also, adjust the headrest as close to your head as possible. For this reason, the use of a cushion that holds the body away from the seatback is not recommended.

## Adjusting the height up and down



- To raise the headrest, pull it up to the desired position (1).
- To lower the headrest, push and hold the release button (2) on the headrest support and lower the headrest to the desired position (3).

## Removal and reinstallation



- To remove the headrest, raise it as far as it can go then press the release button (1) while pulling the headrest upward (2).
- To reinstall the headrest, put the headrest poles (3) into the holes while pressing the release button (1).

Then adjust it to the appropriate height and ensure that it locks in position.

## Armrest (if equipped)



To use the armrest, pull it forward from the seatback.

## Folding the rear seat

The rear seatbacks may be folded to facilitate carrying long items or to increase the luggage capacity of the vehicle.

## Folding down the rear seatback

1. Set the front seatback to the upright position and, if necessary, slide the front seat forward.
2. Lower the rear headrests to the lowest position.

**⚠ WARNING**

**Objects**

Objects carried on the folded down seatback should not extend higher than the top of the front seatbacks. Otherwise, cargo may slide forward and cause injury or damage during sudden stops.

- When folding the seatback, insert the rear seat belt buckle in the pocket between the rear seatback and cushion. Make sure both seat belts do not interfere with stowed luggage and cargo. Then, the seat belt webbing should be placed in the webbing guide to prevent the seat belt from being damaged by loaded cargo, etc. If the seat belt is loose, it may cause damage or noise. In that case, return the seatback to the upright position and put the webbing out from the guide to realign it.

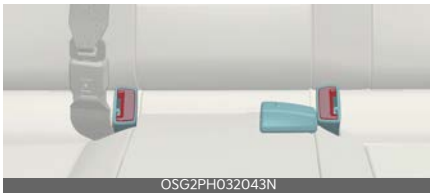

- Pull on the seatback folding lever, then fold the seat toward the front of the vehicle.



**Unfolding the rear seat**



- To use the rear seat, lift and pull the seatback backward while pulling on the seatback folding lever. Pull the seatback firmly until it clicks into place. Make sure the seatback is locked in place. When you return the seatback to its upright position, always be sure it has locked into position by pushing on the top of the seatback.
- Return the rear seat belt to the proper position.
- When the seatback is completely installed, check the seatback folding lever again.

**⚠ WARNING**

**Uprighting seat**

When you return the seatback to its upright position, hold the seatback and return it slowly. If the seatback is returned without holding it, the back of the seat could spring forward, resulting in injury caused by being struck by the seatback.

**⚠ WARNING****Rear seatback**

To ensure maximum protection in the event of an accident or sudden stop, when returning the rear seat to the upright position:

- Be careful not to damage the seat belt webbing or buckle.
- Do not allow the seat belt webbing or buckle to become pinched or caught in the rear seat.
- Ensure the seatback is completely locked into its upright position by pushing on the top of the seatback. Failure to adhere to any of these instructions could result in serious injury or death in the event of a crash.

**⚠ CAUTION****Damaging rear seat belt buckles**

When you fold the rear seatback, insert the buckle between the rear seatback and cushion. Doing so can prevent the buckle from being damaged by the rear seatback.

**⚠ CAUTION****Rear seat belts**

When returning the rear seatbacks to the upright position, remember to return the rear shoulder belts to their proper position.

**⚠ WARNING**

Unless the driver's position is properly set according to the driver's physical figure, do not fold the rear seat. It may increase bodily injuries in a sudden stop or collision.

**⚠ CAUTION**

Be careful when loading cargo through the rear passenger seats to prevent damage to the vehicle interior.

**⚠ WARNING****Cargo**

Cargo should always be secured to prevent it from being thrown about the vehicle in a collision and causing injury to the vehicle occupants. Do not place objects in the rear seats, since they cannot be properly secured and may hit the front seat occupants in a collision.

**Cargo loading**

Make sure the engine is off, the transmission is in P (Park) and the parking brake is securely applied whenever loading or unloading cargo. Failure to take these steps may allow the vehicle to move if the shifter dial is inadvertently moved to another position.

## Seat belts

Seat belts are designed to bear upon the bony structure of the body, and should be worn low across the front of the pelvis, chest and shoulders.

### Seat belt restraint system

For maximum restraint system protection, the seat belts must always be used whenever the vehicle is moving.

- A properly positioned shoulder belt should be positioned midway over your shoulder, across your collarbone.
- Never allow children to ride in the front passenger seat. See "Child Restraint System (CRS)" on page 4-25 for further discussion.

#### **⚠ WARNING**

### Twisted seat belt

Make sure your seat belt is not twisted when worn. A twisted seat belt may not properly protect you in an accident and could even cut into your body.

#### **⚠ WARNING**

### Shoulder Belt

- Never wear the shoulder belt under your arm or behind your back. An improperly positioned shoulder belt cannot protect the occupant in the event of a crash.
- Always wear both the shoulder portion and lap portion of the lap/shoulder belt.

#### **⚠ WARNING**

### Damaged seat belt

Any damage in webbing or hardware may lead to serious injury or death in a crash. For your safety, replace the entire seat belt assembly when any part of the webbing or hardware is damaged.

Seat belts are designed to bear upon the bony structure of the body, and should be worn low across the front of the pelvis, chest and shoulders, as applicable; wearing the lap section of the belt across the abdominal area must be avoided.

Seat belts should be adjusted as firmly as possible, consistent with comfort, to provide the protection for which they have been designed.

A slack belt will greatly reduce the protection afforded to the wearer.

Care should be taken to avoid contamination of the webbing with polishes, oils and chemicals, and particularly battery acid. Cleaning may safely be carried out using mild soap and water. The belt should be replaced if webbing becomes frayed, contaminated or damaged.

- No modifications or additions should be made by the user which would either prevent the seat belt adjusting devices from operating to remove slack, or prevent the seat belt assembly from being adjusted to remove slack.
- When you fasten the seat belt, be careful not to latch the seat belt in buckles of other seats. It is very dangerous and you may not be protected by the seat belt properly.
- Do not unfasten the seat belt and do not fasten and unfasten the seat belt repeatedly while driving. This could result in loss of control, and an acci-

dent causing death, serious injury, or property damage.

- When fastening the seat belt, make sure that the seat belt does not pass over objects that are hard or can break easily.

### **⚠ WARNING**

#### **Seat belt buckle**

Do not allow foreign material (gum, crumbs, coins, liquids, etc.) to obstruct the seat belt buckle. This may prevent the seat belt from fastening securely.

#### **Seat belt warning**



The seat belt warning light and warning chime operate under the following conditions.

#### **Driver's seat belt warning**

As a reminder to the driver, the seat belt warning light will appear for approximately 6 seconds each time you turn the ENGINE START/STOP button ON regardless of belt fastening. If the seat-belt is not fastened, the warning chime will sound for about 6 seconds.

If you start to drive without the seat belt fastened over approximately 9 km/h (5 mph) and less than approximately 20 km/h (12 mph), the corresponding warning light will appear. The warning light will turn off when the vehicle speed drops below approximately 9 km/h (5 mph).

If you start to drive without the seat belt fastened or you unfasten the seat belt

when you drive approximately 20 km/h (12 mph) and faster, the warning light will blink and warning chime will sound for approximately 100 seconds. When the seat belt is unfastened during driving, the warning light will appear when the speed is under approximately 20 km/h (12 mph). When the speed is approximately 20 km/h (12 mph) and faster, the warning light will blink and warning chime will sound for approximately 100 seconds.

#### **Front passenger's seat belt warning**

As a reminder to the front passenger, the seat belt warning light will appear for approximately 6 seconds each time you turn the ENGINE START/STOP button ON regardless of belt fastening. If you start to drive without the passenger seat belt fastened when you drive over approximately 9 km/h (5 mph) and less than approximately 20 km/h (12 mph), the corresponding warning light will appear. The warning light will turn off when the vehicle speed drops approximately below 9 km/h (5 mph).

If you start to drive without the passenger seat belt fastened or you unfasten the seat belt when you drive approximately 20 km/h (12 mph) and faster, the warning light will blink and warning chime will sound for approximately 100 seconds. When the passenger seat belt is unfastened during driving, the warning light will appear when the speed is approximately under 20 km/h (12 mph). When the speed is approximately 20 km/h (12 mph) and faster, the warning light will blink and warning chime will sound for approximately 100 seconds.



**\* NOTICE**

- Even if the front passenger seat is not occupied, the seat belt warning light will appear for approximately 6 seconds.
- The front passenger's seat belt warning may operate when luggage is placed on the front passenger seat.

**Seat belt - Driver's 3-point system with emergency locking retractor**

The following explains how to fasten and adjust the driver's seat belt.

**Fastening the your seat belt**



- Pull it out of the retractor and insert the metal tab (1) into the buckle (2).  
There will be an audible "click" when the tab locks into the buckle.

**⚠ WARNING**

You should place the lap belt portion as low as possible and snugly across your hips. If the lap belt is located too high on your waist, it may increase the chance of injury in the event of a collision.



The arm closest to the seat belt buckle should be over the belt while the other arm should be under the belt as shown

in the illustration. Never wear the seat belt under the arm closest to the door.

The seat belt automatically adjusts to the proper length only after the lap belt portion is adjusted manually so that it fits snugly around your hips. If you lean forward in a slow, easy motion, the belt will extend and let you move around. If there is a sudden stop or impact, however, the belt will lock into position. It will also lock if you try to lean forward too quickly.

**\* NOTICE**

If you are not able to pull out the seat belt from the retractor, firmly pull the belt out and release it. Then you will be able to pull the belt out smoothly.

**Adjusting the height of shoulder belt**

You can adjust the height of the shoulder belt anchor to one of the 4 positions for maximum comfort and safety.



The height of the adjusting seat belt should not be too close to your neck. The shoulder portion should be adjusted so that it lies across your chest and mid-way over your shoulder near the door and not your neck.

To adjust the height of the seat belt anchor, lower or raise the height adjuster into an appropriate position.

- To raise the height adjuster, pull it up (1).

- To lower it, push it down (3) while pressing the height adjuster button (2).

Release the button to lock the anchor into position. Try sliding the height adjuster to make sure that it has locked into position.

Improperly positioned seat belts can cause serious injuries in an accident.

### **⚠ WARNING**

#### **Shoulder belt positioning**

Verify the shoulder belt anchor is locked into position at the appropriate height. Never position the shoulder belt across your neck or face. Improperly positioned seat belts can cause serious injuries in an accident.

### **⚠ WARNING**

#### **Seat belt replacement**

After a collision, the seat belt system should be inspected to ensure it is operating normally. Replace any belts that are not functioning appropriately.

#### **Seat belts - Front passenger and rear seat 3-point system with combination locking retractor**

The following explains how to fasten the passenger's and rear seat belts.

##### **Fastening your seat belt:**

Combination retractor type seat belts are installed in the rear seat positions to help accommodate the installation of Child Restraint System. Although a combination retractor is also installed in the front passenger seat position, it is strongly recommended that children always be seated in the rear seat. NEVER place any infant restraint system in the front seat of the vehicle.

This type of seat belt combines the features of both an emergency locking retractor seat belt and an automatic locking retractor seat belts.

- Pull it out of the retractor and insert the metal tab into the buckle. There will be an audible "click" when the tab locks into the buckle. When not securing a child restraint, the seat belt operates in the same way as the driver's seat belt (emergency locking retractor type).

It automatically adjusts to the proper length only after the lap belt portion of the seat belt is adjusted manually so that it fits snugly around your hips.

When the seat belt is fully extended from the retractor to allow the installation of a Child Restraint System, the seat belt operation changes to allow the belt to retract, but not to extend (automatic locking retractor type). Refer to "Securing a child restraint with a lap/shoulder belt" on page 4-31.

### **\* NOTICE**

Although the combination retractor provides the same level of protection for seated passengers in either emergency or automatic locking modes, have the seated passengers use the emergency locking feature for improved convenience. The automatic locking function is intended to facilitate child restraint installation. To convert from the automatic locking feature to the emergency locking operation mode, allow the unbuckled seat belt to fully retract.

### **⚠ CAUTION**

Do NOT fold down the left portion of the rear seatback when the rear center seat belt is buckled. ALWAYS UNBUCKLE the

rear center seat belt before folding down the left portion of the rear seatback. If the rear center seat belt is buckled when the left portion of the rear seatback is folded down, distortion and damage to the top portion of the seatback and seat belt garnish may result, causing the seatback to lock into the folded down position.

The seat belt should be locked into the buckle on each seat cushion to be properly fastened.



- 1 Rear right seat belt fastening buckle
- 2 Rear center seat belt fastening buckle
- 3 Rear left seat belt fastening buckle

**⚠ WARNING**

Prior to fastening the rear seat belts, ensure the latch matches the seat belt buckle. Forcefully fastening the left or right seat belt to the center buckle can result in an improper fastening scenario that will not protect you in an accident.

When using the rear center seat belt, the buckle with the "CENTER" mark must be used.

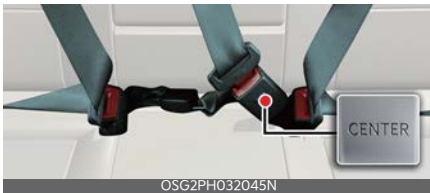

**Stowing the rear seat belt**

The rear seat belt buckles can be stowed in the pocket between the rear seatback and cushion when not in use.



1. Route the seat belt webbing through the rear seat belt guides. It will help keep the belts from being trapped behind or under the seats.
2. After inserting the seat belt, tighten the belt webbing by pulling it up.

**⚠ CAUTION**

When pulling out to wear the seat belt, the tongue should be slowly pulled out of the seat belt guide so that the seat belt guide does not come off the trim.

**Releasing the seat belt**



- The seat belt is released by pressing the release button (1) on the locking buckle.

When it is released, the belt should automatically draw back into the retractor.

If this does not happen, check the belt to make sure it is not twisted, then try again.

### Pre-tensioner seat belt

Your vehicle is equipped with driver's pre-tensioner seat belts (retractor pre-tensioner).



The pre-tensioner seat belts may be activated, when a frontal collision is severe enough, together with the air bags.

When the vehicle stops suddenly, or if the occupant tries to lean forward too quickly, the seat belt retractor may lock into position. In certain frontal collisions, the pre-tensioner will activate and pull the seat belt into tighter contact against the occupant's body.

#### 1 Retractor Pre-tensioner

The purpose of the retractor pre-tensioner is to make sure that the shoulder belts fit in tightly against the occupant's upper body in certain frontal collisions.

If the system senses excessive tension on the driver or passenger's seat belt when the pre-tensioner system activates, the load limiter inside the retractor pre-tensioner will release some of the pressure on the affected seat belt.

#### \* NOTICE

When the pre-tensioner seat belts are activated, a loud noise may be heard and fine dust, which may appear to be smoke, may be visible in the passenger compartment. These are normal operating conditions and are not hazardous.

The seat belt pre-tensioner system consists mainly of the following components. Their locations are shown in the illustration:

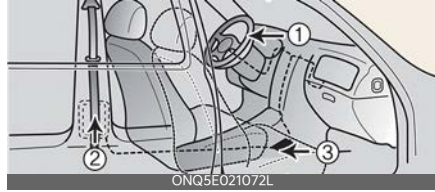

\* The actual position of seat belt pre-tensioner system components may differ from the illustration.

- 1 SRS air bag warning light
- 2 Retractor pre-tensioner assembly
- 3 SRS control module

#### ⚠ WARNING

##### Skin Irritation

Wash all exposed skin areas thoroughly after an accident in which the pre-tensioner seat belts were activated. The fine dust from the pre-tensioner activation may cause skin irritation and should not be inhaled for prolonged periods.

#### \* NOTICE

- Both the driver's and front passenger's seat belt pre-tensioner systems may be activated not only in certain frontal collisions, but also in certain side collisions or rollovers, if the vehicle is equipped with a side or curtain air bag.
- Because the sensor that activates the SRS air bag is connected with the pre-tensioner seat belt, the SRS air bag warning light  on the instrument panel will appear for approximately 3~6 seconds after the ignition switch

has been turned to the ON position, and then it should turn off.

- If the pre-tensioner seat belt system is not working properly, this warning light will appear even if there is not a malfunction with the SRS air bag. If the SRS air bag warning light does not appear when the ignition switch has been turned to the ON position, or if it remains illuminated after appearing for approximately 6 seconds, or if it appears while the vehicle is being driven, have an authorized Kia dealer inspect the pre-tensioner seat belt and SRS air bag system as soon as possible.

#### \* NOTICE

Do not attempt to service or repair the pre-tensioner seat belt system in any manner. Do not attempt to inspect or replace the pre-tensioner seat belts yourself. This must be done by an authorized Kia dealer.

#### ▲ WARNING

##### Hot pre-tensioner

Do not touch the pre-tensioner seat belt assemblies for several minutes after they have been activated. When the pre-tensioner seat belt mechanism fires during a collision the pre-tensioner becomes hot and can burn you.

Pre-tensioners are designed to operate only one time. After activation, pre-tensioner seat belts must be replaced. If the pre-tensioner must be replaced, contact an authorized Kia dealer.

##### Seat belt precautions

Take the following precautions when using seat belts.

##### Infant or small child

Most countries have child restraint laws. You should be aware of the specific requirements in your country. Child and/or infant seats must be properly placed and installed in the rear seat. For more information about the use of these restraints, refer to "Child Restraint System (CRS)" on page 4-25.

#### \* NOTICE

Small children are best protected from injury in an accident when properly restrained in the rear seat by a Child Restraint System that meets the requirements of the Safety Standards of your country. Before buying any Child Restraint System, make sure that it has a label certifying that it meets Safety Standards of your country. The restraint must be appropriate for your child's height and weight. Check the label on the child restraint for this information. Refer to "Child Restraint System (CRS)" on page 4-25.

##### Larger children

Children who are too large for Child Restraint System should always occupy the rear seat and use the available lap/shoulder belts. The lap portion should be fastened and snug on the hips as low as possible. Check periodically to insure that the belt fits. A child's squirming could put the belt out of position. Children are given the most safety in the event of an accident when they are restrained by a proper restraint system in the rear seat. If a larger child (over age 13) must be seated in the front seat, the child should be securely restrained by the available lap/shoulder belt and the seat should be placed in the rearmost

position. Children age 13 and under should be restrained securely in the rear seat. NEVER place a child age 13 and under in the front seat. NEVER place a rear facing child seat in the front seat of a vehicle.

If the shoulder belt portion slightly touches the child's neck or face, try placing the child closer to the center of the vehicle. If the shoulder belt still touches their face or neck they need to be returned to a Child Restraint System.

### WARNING

#### **Small children**

Do not allow small children to ride in the vehicle without an appropriate Child Restraint System. If the shoulder belt comes in contact with your child's neck or face, your child is too small to ride in the vehicle. In a crash, the seat belt will inflict injury to your child's neck, throat and face.

---

#### **Restraint of pregnant women**

Pregnant women should wear lap/shoulder belt assemblies whenever possible according to specific recommendations by their doctors. The lap portion of the belt should be worn AS SECURELY AND LOW AS POSSIBLE.

### WARNING

#### **Pregnant women**

Pregnant women must never place the lap portion of the seat belt above or on the abdomen where the fetus is located. The force of the seat belt during a collision will crush the fetus.

---

#### **Injured person**

A seat belt should be used when an injured person is being transported. When this is necessary, you should consult a physician for recommendations.

#### **One person per belt**

Two people (including children) should never attempt to use a single seat belt. This could increase the severity of injuries in case of an accident.

#### **Do not lie down**

To reduce the chance of injuries in the event of an accident and to achieve maximum effectiveness of the restraint system, all passengers should be sitting up and the front and rear seats should be in an upright position when the vehicle is moving. A seat belt cannot provide proper protection if the person is lying down in the rear seat or if the front and rear seats are in a reclined position.

#### **Care of seat belts**

Seat belt systems should never be disassembled or modified. In addition, care should be taken to assure that seat belts and belt hardware are not damaged by seat hinges, doors or other abuse.

**⚠ WARNING****Pinched seat belt**

Make sure that the webbing and/or buckle does not get caught or pinched in the rear seat when returning the rear seatback to its upright position. A caught or pinched webbing/buckle may become damaged and could fail during a collision or sudden stop.

**⚠ WARNING**

Seatbelts can become hot in a vehicle that has been closed up in sunny weather. Please handle with care, as they could burn infants and children, if used abruptly.

**Periodic inspection**

All seat belts should be inspected periodically for wear or damage of any kind. Any damaged parts should be replaced as soon as possible.

**Keep belts clean and dry**

Seat belts should be kept clean and dry. If belts become dirty, they can be cleaned by using a mild soap solution and warm water. Bleach, dye, strong detergents or abrasives should not be used because they may damage and weaken the fabric.

**When to replace seat belts**

The entire in-use seat belt assembly or assemblies should be replaced if the vehicle has been involved in an accident. This should be done even if no damage is visible. Additional questions concerning seat belt operation should be directed to an authorized Kia dealer.

**Child Restraint System (CRS)**

Infants and younger children must be restrained in an appropriate rear-facing or forward-facing Child Restraint System (CRS) that has first been properly secured to the rear seat of the vehicle.

Infants and younger children must be restrained in an appropriate rear-facing or forward-facing Child Restraint System (CRS) that has first been properly secured to the rear seat of the vehicle. Please refer to your state or federal laws for child seating requirements in the operation of a motor vehicle.

**Children always in the rear**

Children under age 13 must always ride in the rear seats and must always be properly restrained to minimize the risk of injury in an accident, sudden stop or sudden maneuver.

**⚠ WARNING****Restraint Location**

Never install a child or infant seat on the front passenger's seat. A child riding in the front passenger seat can be forcefully struck by an inflating airbag and get seriously injured.

**⚠ WARNING****Hot Child Restraint**

A Child Restraint System can become very hot if it is left in a closed vehicle on a sunny day. Be sure to check the seat cover, buckles and latches before placing a child in the restraint system.

According to accident statistics, children are safer when properly restrained in the rear seats than in the front seat. Even with air bags, children can be seriously injured or killed. Children too large for a

child restraint must use the seat belts provided.

Most countries have child restraint laws which require children to travel in approved child restraint devices. The laws governing the age or height/weight restrictions at which seat belts can be used instead of child restraints differs among countries, so you should be aware of the specific requirements in your country, and where you are traveling.

Child restraint systems must be properly placed and installed in the rear seat. You must use a commercially available child restraint system that meets the requirements of the Safety Standards of your country.

A CRS is generally designed to be secured in a vehicle seat by lap belt portion of a lap/shoulder belt, or by a LATCH system in the rear seats of the vehicle.

### Child Restraint System (CRS)

Infants and younger children must be restrained in an appropriate rear-facing or forward-facing CRS that has first been properly secured to the rear seat of the vehicle. Read and comply with the instructions for installation and use provided by the manufacturer of the CRS.

### Child Restraint Installation

An improperly secured child restraint can increase the risk of serious injury or death in an accident. Always take the following precautions when using a Child Restraint System:

- Always follow the Child Restraint System manufacturer's instructions for installation and use.

- Always properly restrain your child in the child restraint.
- If the vehicle head restraint prevents proper installation of a child seat (as described in the Child Restraint System manual), the head restraint of the respective seating position shall be readjusted or entirely removed.
- Do not use an infant carrier or a child safety seat that "hooks" over a seat-back as it may not provide adequate protection in an accident.
- A child restraint in the center seating position may also contact or push up against the safety belt buckles, which can damage the buckles and make them unusable or unsafe. Always check that the child restraint does not contact any of the safety belt buckles. Check the placement of the child restraint regularly to make sure that it has not shifted and come into contact with any of the safety belt buckles.

### \* NOTICE

After an accident, have a Kia dealer check the Child Restraint System, seat belts, tether anchors and lower anchors.

### Selecting a CRS

When selecting a CRS for your child, always:

- Make sure the CRS has a label certifying that it meets applicable Safety Standards of your country.
- Select a child restraint based on your child's height and weight. The required label or the instructions for use typically provide this information.
- Select a child restraint that fits the vehicle seating position where it will be used.



- Read and comply with the warnings and instructions for installation and use provided with the CRS.
- The American Academy of Pediatrics provides helpful fit and safety information about child restraints at [www.healthychildren.org](http://www.healthychildren.org).

### **⚠ WARNING**

#### **Holding children**

Never hold a child in your arms or lap when riding in a vehicle. The violent forces created during a crash will tear the child from your arms and throw the child against the car's interior. Always use a Child Restraint System which is appropriate for your child's height and weight.

### **⚠ WARNING**

#### **C or pets**

An enclosed vehicle can become extremely hot, causing death or severe injury such as heatstroke to unattended children, the elderly or pets who cannot escape the vehicle. When left or trapped in a hot vehicle, make sure to stay hydrated and avoid sun exposure through the vehicle's windshield. Furthermore, children might operate features of the vehicle that could injure them, or they could encounter other harm, possibly from someone gaining entry to the vehicle. Never leave children or animals unattended in your vehicle.

### **⚠ WARNING**

#### **Seat belt use**

Do not use one seat belt for two occupants at the same time. This will eliminate any safety benefit provided by the seat belt to the occupants.

#### **CRS types**

There are three main types of the CRS: rear-facing seats, forward-facing seats, and booster seats. They are classified according to the child's age, height and weight.

#### **Rear-facing child seats**



A rear-facing child seat provides restraint with the seating surface against the back of the child. The harness system holds the child in place, and in an accident, acts to keep the child positioned in the seat and reduces the stress to the neck and spinal cord.

All children under age one must always ride in a rear-facing infant child restraint.

Convertible and 3-in-1 child seats typically have higher height and weight limits for the rear-facing position, allowing you to keep your child rear-facing for a longer period of time.

Continue to use a rear-facing child seat for as long as your child will fit within the height and weight limits allowed by the child seat manufacturer. It's the best way to keep them safe. Once your child has

outgrown the rear-facing child restraint, your child is ready for a forward-facing child restraint with a harness.

### Forward-facing child restraints



A forward-facing child seat provides restraint for the child's body with a harness. Keep children in a forward-facing child seat with a harness until they reach the top height or weight limit allowed by your child restraint's manufacturer.

Once your child outgrows the forward-facing child restraint, your child is ready for a booster seat.

### Booster seats

A booster seat is a restraint designed to improve the fit of the vehicle's seat belt system. A booster seat positions the seat belt so that it fits properly over the lap of your child.

Keep your child in a booster seat until they are big enough to sit in the seat without a booster and still have the seat belt fit properly. For a seat belt to fit properly, the lap belt must lie snugly across the upper thighs, not the stomach. The shoulder belt should lie snug across the shoulder and chest and not across the neck or face. Children under age 13 must always ride in the rear seats and must always be properly restrained to minimize the risk of injury.

### Installing a CRS

After selecting a proper child seat for your child, check to make sure it fits properly in your vehicle.

Follow the instructions provided by the manufacturer when installing the child seat. Note these general steps when installing the seat to your vehicle:

- **Properly secure the child restraint to the vehicle.** All child restraints must be secured to the vehicle with the lap part of a lap/shoulder belt or with the LATCH system.
- **Make sure the child restraint is firmly secured.** After installing a child restraint to the vehicle, push and pull the seat forward and from side-to-side to verify that it is securely attached to the seat. A child restraint secured with a seat belt should be installed as firmly as possible. However, some side-to-side movement can be expected.
- **Secure the child in the child restraint.** Make sure the child is properly strapped in the child restraint according to the manufacturer instructions.

### Lower Anchors and Tether for Children (LATCH) system

The LATCH system holds a child restraint during driving and in an accident. This system is designed to make installation of the child restraint easier and reduce the possibility of improperly installing your child restraint. The LATCH system uses anchors in the vehicle and attachments on the child restraint. The LATCH system eliminates the need to use seat belts to secure the child restraint to the rear seats.

Lower anchors are metal bars built into the vehicle. There are two lower anchors for each LATCH seating position that will accommodate a child restraint with lower attachments.

To use the LATCH system in your vehicle, you must have a child restraint with LATCH attachments.

The child seat manufacturer will provide you with instructions on how to use the child seat with its attachments for the LATCH lower anchors.



LATCH anchors have been provided in the left and right outboard rear seating positions. Their locations are shown in the illustration. There are no LATCH anchors provided for the center rear seating position.

**⚠ WARNING**

**LATCH Lower Anchors**

Never attempt to attach a LATCH equipped seat in the center seating position. LATCH lower anchors are only to be used in the left and right rear outboard seating positions. You may damage the anchors or the anchors may fail and break in a collision if the seat is in the center seating position.

The lower anchor position indicator symbols are located on the left and right rear seatbacks to identify the position of the lower anchors in your vehicle (see arrows in illustration).



- 1 Lower Anchor position indicator
- 2 Lower Anchor

The LATCH anchors are located between the seatback and the seat cushion of the rear seat left and right outboard seating positions.

To use the lower anchor, push the upper portion of the lower anchor cover.

**Securing a child restraint with the LATCH anchors system**

To install a LATCH-compatible child restraint in either of the rear outboard seating positions:

1. Move the seat belt buckle away from the lower anchors. Otherwise, the webbing or buckle can be damaged by the latch anchor, which can make them become unusable or unsafe.
2. Move any other objects away from the anchors that could prevent a secure connection between the child restraint and the lower anchors.

3. Place the child restraint on the vehicle seat, then attach the seat to the lower anchors according to the instructions provided by the child restraint manufacturer.
4. Follow the child restraint instructions for properly adjusting and tightening the lower attachments on the child restraint to the lower anchors.

**⚠ WARNING**

Take the following precautions when using the LATCH system:

- Read and follow all installation instructions provided with your Child Restraint System.
- To prevent the child from reaching and taking hold of the unused seat belts, buckle all unused rear seat belts before the child is placed into the vehicle. Lock each unused seatbelt following the instructions in the "automatic locking mode" subsection, and place the webbing behind the child seat or against an unused seatback. Children can be strangled if a shoulder belt becomes wrapped around their neck and the seat belt tightens.
- NEVER attach more than one child restraint to a single anchor. This could cause the anchor or attachment to come loose or break.
- Always have the LATCH system inspected by your authorized Kia dealer after an accident. An accident can damage the LATCH system and may not properly secure the child restraint.

**Securing a child restraint seat with "Tether Anchor" system**



First secure the child restraint with the LATCH lower anchors or the seat belt. If the child restraint manufacturer recommends that the top tether strap be attached, attach and tighten the top tether strap to the top tether strap anchor.

Child Restraint hook holders are located on the seat back.

**⚠ WARNING**

Take the following precautions when installing the tether strap:

- Read and follow all installation instructions provided with your Child Restraint System.
- NEVER attach more than one child restraint to a single tether anchor. This could cause the anchor or attachment to come loose or break.
- Do not attach the tether strap to anything other than the correct tether anchor. It may not work properly if attached to something else.
- Do not use the tether anchors for adult seat belts or harnesses, or for attaching other items or equipment to the vehicle.
- Always fasten the seat belts behind the child restraint seat when they are not used to secure the child seat. Failure to do so may result in child strangulation.

To install the tether anchor:



1. Route the Child Restraint System seat strap over the seatback.  
For vehicles with adjustable headrest, route the tether strap under the headrest and between the headrest posts, otherwise route the tether strap over the top of the seatback.
2. Connect the top-tether to the top-tether anchorage, then tighten the top-tether according to the instructions of your Child Restraint System's manufacturer to firmly attach the Child Restraint System to the seat.
3. Check that the child restraint is securely attached to the seat by pushing and pulling the seat forward and from side-to-side.

## Securing a child restraint with a lap/shoulder belt

When not using the LATCH system, all child restraints must be secured to a vehicle rear seat with the lap part of a lap/shoulder belt.

## Automatic locking mode



All passenger seat belts move freely under normal conditions and only lock under extreme or emergency conditions (emergency locking mode). So, in order to secure a child restraint, you must manually pull the seat belt all the way out to shift the retractor to the "automatic locking" mode.

The "automatic locking" mode will help prevent the normal movement of the child in the vehicle from causing the seat belt to loosen and compromise the CRS. To install a CRS on the rear seats, do the following:

1. Place the CRS on a rear seat and route the lap/shoulder belt around or through the child restraint, following the restraint manufacturer's instructions.  
Be sure the seat belt webbing is not twisted.
2. Fasten the lap/shoulder belt latch into the buckle. Listen for the distinct "click" sound.  
Position the release button so that it is easy to access in case of an emergency.



3. Pull the shoulder portion of the seat belt all the way out. When the shoulder portion of the seat belt is fully extended, it will shift the retractor to the "automatic locking" (child restraint) mode.



4. Slowly allow the shoulder portion of the seat belt to retract and listen for an audible "clicking" or "ratcheting" sound. This indicates that the retractor is in the "automatic locking" mode. If no distinct sound is heard, repeat steps 3 and 4.



5. Remove as much slack from the belt as possible by pushing down on the CRS while feeding the shoulder belt back into the retractor.
6. Push and pull on the CRS to confirm that the seat belt is holding it firmly in place. If it is not, release the seat belt and repeat steps 2 through 6.

7. Double check that the retractor is in the "automatic locking" mode by attempting to pull more of the seat belt out of the retractor. If you cannot, the retractor is in the "automatic locking" mode.

If your CRS manufacturer instructs or recommends you to use a tether anchor with the lap/shoulder belt, refer to "Securing a child restraint with the LATCH anchors system" on page 4-29 for more information.

**\* NOTICE**

When the seat belt is allowed to retract to its fully stowed position, the retractor will automatically switch from the "automatic locking" mode to the emergency lock mode for normal adult usage.

**⚠ WARNING**

**Auto lock mode**

Set the retractor to Automatic Lock mode when installing any Child Restraint System. If the retractor is not in the automatic locking mode, the child restraint can move when your vehicle turns or stops suddenly. A child can be seriously injured or killed if the child restraint is not properly anchored in the car.

To remove the child restraint, press the release button on the buckle and then pull the lap/shoulder belt out of the restraint and allow the seat belt to retract fully.

## Air bag - advanced Supplemental Restraint System

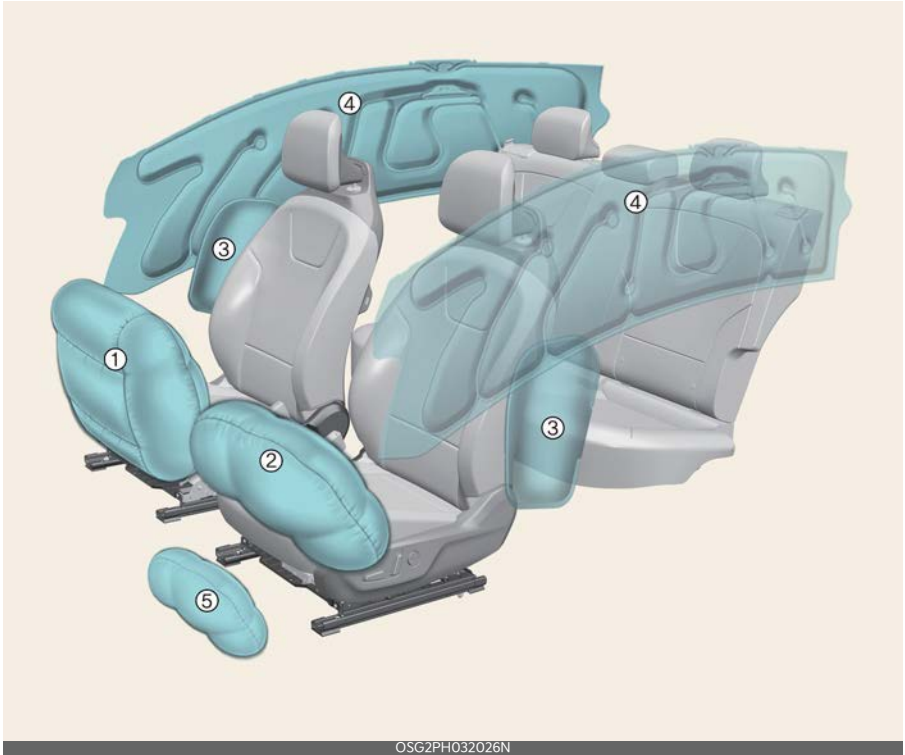

\* The actual air bags in the vehicle may differ from the illustration.

- 1 Passenger's front air bag
- 2 Driver's front air bag
- 3 Side air bag
- 4 Curtain air bag
- 5 Driver's knee air bag

Even in vehicles with air bags, you and your passengers must always wear the safety belts provided in order to minimize the risk and severity of injury in the event of a collision or rollover.

## How does the air bag system operate?

- Air bags are activated (able to inflate if necessary) only when the ENGINE START/STOP button has been turned to the ON position.
- The appropriate air bags inflate instantly in the event of a serious frontal collision or side collision in order to help protect the occupants from serious physical injury.
- There is no single speed at which the air bags will inflate. Generally, air bags are designed to inflate based upon the severity of a collision and its direction, etc. Several factors determine whether the sensors produce an electronic deployment / inflation signal.
- Air bags will not deploy in every crash or collision situations. Air bag deployment depends on a number of factors including vehicle speed, angles of impact, and, the density and stiffness of the vehicles or objects which your vehicle hits in the collision. The determining factors are not limited to those mentioned above.
- The front air bags will completely inflate and deflate in an instant. It is virtually impossible for you to see the air bags inflate during an accident. It is much more likely that you will simply see the deflated air bags hanging out of their storage compartments after the collision.
- In addition to inflating in serious side collisions, side and/or curtain air bags will inflate if the sensing system detects a rollover.
- When a rollover is detected, side and/or curtain airbags will remain inflated longer. This helps provide protection from ejection, especially when used in conjunction with the seat belts.
- In order to help provide protection, the air bags must inflate rapidly. The airbag inflates extremely fast between the occupant and the vehicle structures before the occupant impacts the vehicle structures. This speed of inflation reduces the risk of serious or life-threatening injuries and is thus a necessary part of the air bag design. However, airbag inflation can also cause injuries which can include facial abrasions, bruises and broken bones. This is because the rapid inflation also causes the airbags to expand with a great deal of force.
- **There are even circumstances under which contact with the steering wheel or passenger air bag can cause fatal injuries, especially if the occupant is positioned excessively close to the steering wheel or passenger air bag.**

### **WARNING**

#### **Airbag inflation**

Sit as far back as possible from the steering wheel while still maintaining comfortable control of the vehicle. A distance of at least 25 cm (10 inches) from your chest to the steering wheel is recommended. Failure to do so can result in airbag inflation injuries to the driver.

---



## Noise and smoke

When inflated, the air bags make a loud noise and leave smoke and powder in the air inside the vehicle. This is normal and is a result of the ignition of the air bag inflator. After the air bag inflates, you may feel substantial discomfort in breathing due to the contact of your chest with both the seat belt and the air bag, as well as from breathing the smoke and powder. **Open your doors and/or windows as soon as possible after impact in order to reduce discomfort and prevent prolonged exposure to the smoke and powder.**

Though smoke and powder are non-toxic, it may cause irritation to the skin (eyes, nose and throat, etc). If this is the case, wash and rinse with cold water immediately and consult a doctor if the symptom persists.

### WARNING

#### Hot components

Do not touch the air bag storage area's internal components immediately after airbag inflation. The air bag related parts in the steering wheel, instrument panel and the roof rails above the front and rear doors are very hot. Hot components can result in burn injuries.

### WARNING

Do not install or place any accessories near air bag deployment areas, such as the instrument panel, windows, pillars, and roof rails.

## Do not install a child restraint on the front passenger's seat

Never place a rear-facing child restraint in the front passenger's seat.



If the air bag deploys, it would impact the rear-facing child restraint, causing serious or fatal injury.

In addition, do not place front-facing child restraints in the front passenger's seat. If the front passenger air bag inflates, it could cause serious or fatal injuries to the child.

### WARNING

#### Air bag deployment

When children are seated in the rear outboard seats of a vehicle equipped with side and/or curtain air bags, install the Child Restraint System as far away from the door side as possible. Inflation of the side and/or curtain air bags could impact the child.

#### Air bag warning light

The purpose of air bag warning light in your instrument panel is to alert you of a potential problem with your air bag system, which could include your side and/or curtain air bags used for rollover protection.



If the air bag warning light appears for more than 3~6 seconds after the

## Safety features of your vehicle

ENGINE START/STOP button has been turned to the ON position, or if it appears during vehicle operation, an SRS component may not be functioning properly and you should have your vehicle checked by an authorized Kia dealer.

If any of the following conditions occur, this indicates a malfunction in the air bag system. Have an authorized Kia dealer inspect the air bag system as soon as possible.

- The light does not turn on briefly when you turn the ENGINE START/STOP button to the ON position.
- The light stays on after appearing for approximately 6 seconds.
- The light comes on while the vehicle is in motion.
- The light blinks when the ENGINE START/STOP button to the ON position.

## Supplemental Restraint System (SRS) components and functions

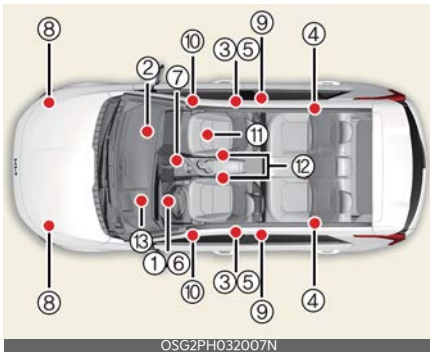

\* The actual position of SRS components may differ from the illustration.

The SRS consists of the following components:

- 1 Driver's front air bag module
- 2 Passenger's front air bag module
- 3 Side air bag modules

## Air bag - advanced Supplemental Restraint System

- 4 Curtain air bag modules
- 5 Retractor pre-tensioner assemblies
- 6 Air bag warning light
- 7 SRS control module (SRSCM)/ rollover sensor
- 8 Front impact sensors
- 9 Side impact sensors
- 10 Side pressure sensors
- 11 Occupant Detection System
- 12 Front driver/passenger's seat belt buckle sensor
- 13 Driver's knee air bag module

Driver's front air bag (1)



The front air bag modules are located both in the center of the steering wheel and in the front passenger's panel above the glove box. When the SRSCM detects a sufficiently severe impact to the front of the vehicle, it will automatically deploy the front air bags.

Driver's front air bag (2)



Upon deployment, tear seams molded directly into the pad covers will separate under pressure from the expansion of the air bags. Further opening of the covers then allows full inflation of the air bags.

Driver's front air bag (3)



A fully inflated airbag (with a properly fastened seat belt) slows the forward motion of the driver or passenger, reducing the risk of head and chest injury.

After complete inflation, the air bag immediately starts deflating, enabling the driver to maintain forward visibility and the ability to steer or operate other controls.

Passenger's front air bag



**WARNING**

**Air bag obstructions**

Do not install or place any accessories on the steering wheel, instrument panel, or on the front passenger's panel above the glove box in a vehicle. Such objects may become dangerous projectiles if the air bag deploys.

**WARNING**

**Flying objects**

Do not place any objects (an umbrella, bag, etc.) between the front door and the front seat. Such objects may become dangerous projectiles if the side airbag inflates.

- If an air bag deploys, there may be a loud noise followed by a fine dust released in the vehicle. These conditions are normal and are not hazardous - the air bags are packed in this fine powder. The dust generated during air bag deployment may cause skin or eye irritation as well as aggravate asthma for some persons. Always wash all exposed skin areas thoroughly with cold water and a mild soap after an accident in which the air bags were deployed.
- The SRS can function only when the ENGINE START/STOP button is in the ON position. The SRS is not working properly if any of the following situations occur:
  - the SRS airbag warning light does not appear
  - the SRS airbag warning light remains on continuously after appearing for about 3~6 seconds when the ENGINE START/STOP button is turned to the ON position or after the vehicle is in ready mode
  - the SRS airbag warning light comes on while driving

If this occurs, have your vehicle immediately inspected by an authorized Kia dealer.

**\* NOTICE**

Before you replace a fuse or disconnect the battery terminal (For plug-in hybrid vehicle) or the battery connector (For hybrid vehicle), change the ENGINE START/STOP button to the OFF position. Never remove or replace the air bag related fuse(s) when the ENGINE START/STOP button is ON position. Failure to heed this warning will cause the SRS air bag warning light to appear.

## Occupant Detection System (ODS)

Your vehicle is equipped with an Occupant Detection System (ODS) in the front passenger's seat.



The ODS is designed to detect the presence of a properly-seated front passenger and determine if the passenger's front air bag should be enabled (may inflate) or not. Only the front passenger front air bag is controlled by the ODS. Do not put anything in front of the passenger air bag "⊗" icon indicator.

### Main components of the ODS

- A detection device is located within the front passenger seat cushion.
- An electronic system determines whether the passenger air bag systems should be activated or deactivated.
- An indicator light located on the overhead console which appears the words PASSENGER AIR BAG "⊗" icon indicates the front passenger air bag system is deactivated.
- The overhead console air bag warning light is interconnected with the ODS.

If the front passenger seat is occupied by a person that the system determines to be of appropriate size, and he/she sits properly (sitting upright with the seatback in an upright position, centered on the seat cushion with their seat belt on, legs comfortably extended and their feet

on the floor), the PASSENGER AIR BAG "⊗" icon indicator will turn off and the front passenger's air bag will be able to inflate, if necessary, in frontal crashes. You will find the PASSENGER AIR BAG "⊗" icon indicator on the overhead console. This system detects the conditions 1~4 in the following table and activates or deactivates the front passenger air bag based on these conditions.

Always be sure that you and all vehicle occupants are seated and restrained properly (sitting upright with the seat in an upright position, centered on the seat cushion, with the person's legs comfortably extended, feet on the floor, and wearing the safety belt properly) for the most effective protection by the air bag and the safety belt.

The ODS may not function properly if the passenger takes actions which can defeat the detection system. These include:

- Failing to sit in an upright position.
- Leaning against the door or center console.
- Sitting towards the sides or the front of the seat.
- Putting legs on the dashboard or resting them on other locations which reduce the passenger weight on the front seat.
- Improperly wearing the safety belt.
- Reclining the seatback.

## Conditions and operation of the front passenger ODS

Condition detected by the occupant classification system	Indicator/Warning light		Devices
	"PASSENGER AIR BAG OFF" indicator light	SRS warning light	Front passenger air bag
1. Adult <sup>*1</sup>	Off	Off	Activated
2. Child Restraint System (CRS) with child under 12 months old <sup>*2*3*4</sup>	On	Off	Deactivated
3. Unoccupied	On	Off	Deactivated
4. Malfunction in the system	Off	On	Activated

- \*1. The system judges a person of adult size as an adult. When a smaller adult sits in the front passenger seat, the system may recognize him/her as a child depending on his/her physique and posture.
- \*2. Do not allow children to ride in the front passenger seat. When a larger child who has outgrown a CRS sits in the front passenger seat, the system may recognize him/her as an adult depending upon his/her physique or sitting position.
- \*3. Never install a CRS on the front passenger seat.
- \*4. The PASSENGER AIR BAG  indicator may turn on or off when a child above 12 months to 12 years old (with or without a CRS) sits in the front passenger seat. This is a normal condition.

**⚠ WARNING**

- Do not install a child restraint seat in the passenger seat when the seat is heavily soaked with any type of liquid.
- Do not alter or remodel the Occupant Detection System (ODS). This may damage the system and prevent its proper function in a collision.

**\* NOTICE**

- Do not use car seat cushions that cover up the surface of the seat and aftermarket manufactured passenger seat heaters.
- After conducting car interior cleaning using steam or detergent, the seat should be dried properly. Afterward, check for normal operation of the PASSENGER AIR BAG "OFF" and air bag warning lights.
- Any service related to the passenger seat and the ODS must be done at an authorized Kia dealership.
- After the passenger seat has been removed or installed for repair purposes, check for normal operation of the PASSENGER AIR BAG "⊗" and air bag warning lights with a person seated or not seated in the passenger seat.

**⚠ WARNING**

When the PASSENGER AIR BAG "⊗" symbol appears, the passenger air bag system will not operate. The passenger air bag system will operate when necessary if the symbol does not appear.

**\* NOTICE**

Do not modify or replace the front passenger seat. Don't place anything on or attach anything such as a blanket, front seat cover or aftermarket seat heater to the front passenger seat. This can adversely affect the Occupant Detection System.

**⚠ WARNING**

**Occupant Detection System**

Riding in an improper position adversely affects the Occupant Detection System and may result in the deactivation of the front passenger airbag. It is important for the driver to instruct the passenger as to the proper seating instructions as contained in this manual.

- Do not place a heavy load in the front passenger seatback pocket or on the front passenger seat.



- Do not place feet on the front passenger seatback.



## Safety features of your vehicle

- Do not move your hips too forward in the seat.



- Never excessively recline the front passenger seatback.



- Never place feet on the dashboard.



- Never lean on the door or center console.
- Do not sit with your weight excessively skewing to the left or right on the front passenger seat.



- Do not use car seat accessories, such as thick blankets and cushions, that cover up the car seat surface.

## Air bag - advanced Supplemental Restraint System

- Do not sit on the passenger seat wearing heavily padded clothes, such as ski wear and hip protector.



- Do not place electronic devices, such as laptops and DVD player, or conductive materials such as water bottles, on the passenger seat.
- Do not use electronic devices, such as laptops and satellite radios, that use inverter chargers.

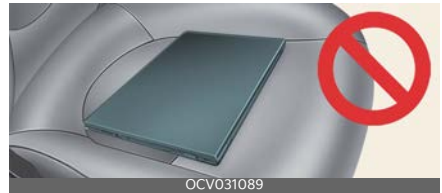

- Wet Passenger Seat

Do not spill liquid in the passenger seat. Spilled liquid on the passenger seat may cause the air bag warning light to appear or malfunction. If any liquid is spilled, make sure the seat has been completely dried before driving the vehicle.

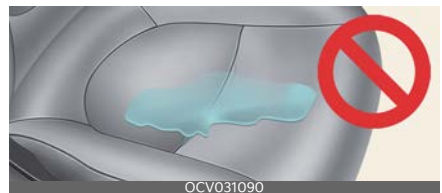

Proper position



When an adult is seated in the front passenger seat, if the PASSENGER AIR BAG "⊗" indicator is on, change the ENGINE START/STOP button to the OFF position and ask the passenger to sit properly (sitting upright with the seatback in an upright position, centered on the seat cushion with their seat belt on, legs comfortably extended and their feet on the floor). Restart the vehicle and have the person remain in that position. This will allow the system to detect the person and to enable the passenger air bag.

If the PASSENGER AIR BAG "⊗" indicator is still on, ask the passenger to move to the rear seat.

**⚠ WARNING**

**PASSENGER AIR BAG "⊗" light**

Do not allow an adult passenger to ride in the front seat when the PASSENGER AIR BAG "⊗" indicator appears, because the air bag will not deploy in the event of a crash. The driver must instruct the passenger to reposition himself in the seat. Failure to properly position yourself may lead to air bag deactivation resulting in air bag non-deployment in a collision. If the PASSENGER AIR BAG "⊗" indicator remains illuminated after the passenger repositions themselves properly and the car is restarted, it is recommended that passenger move to the rear seat because

the passenger's front air bag will not deploy.

**\* NOTICE**

The PASSENGER AIR BAG "⊗" indicator appears for about maximum 4 seconds after the ENGINE START/STOP button is turned to the ON position after the vehicle is started. If the front passenger seat is occupied, the occupant detection sensor will then classify the front passenger after several more seconds.

- Even though your vehicle is equipped with the Occupant Detection System, never install a Child Restraint System in the front passenger's seat. A deploying air bag can forcefully strike a child resulting in serious injuries or death.

Any child age 13 and under should ride in the rear seat. Children too large for child restraints should use the available lap/shoulder belts. No matter what type of crash, children of all ages are safer when restrained in the rear seat.

If the ODS is not working properly, the Supplemental Restraint System (SRS) air bag warning light on the instrument panel will appear because the passenger's front air bag is connected with the ODS. If there is a malfunction of the ODS the PASSENGER AIR BAG "⊗" indicator will not appear. In this case, the passenger's front airbag will inflate in frontal impact crashes even if there is no occupant in the front passenger seat.



## Driver's and passenger's front air bag

Your vehicle is equipped with an advanced supplemental restraint (air bag) system and lap/shoulder belts at both the driver and passenger seating position.

Driver's front air bag



Driver's knee air bag



Passenger's front air bag



The indication of the system's presence are the letters "AIR BAG" located on the air bag pad cover on the steering wheel and the passenger's side front panel pad above the glove box.

The Supplemental Restraint System (SRS) consists of air bags installed under the pad covers in the center of the steering wheel and the passenger's side front panel above the glove box.

The purpose of the SRS is to provide the vehicle's driver and/or the front passen-

ger with additional protection than that offered by the seat belt system alone in case of a frontal impact of sufficient severity. The SRS uses sensors to gather information about the driver's and front passenger's seat belt usage and impact severity.

The seat belt buckle sensor determines if the front passenger's seat belt is fastened.

These sensors provide the ability to control the SRS deployment based on whether or not the seat belts are fastened, and how severe the impact is.

The advanced SRS offers the ability to control the air bag inflation with two levels. A first stage level is provided for moderate-severity impacts. A second stage level is provided for more severe impacts.

According to the impact severity and seat belt usage, the SRS Control Module (SRSCM) controls the air bag inflation. Failure to properly wear seat belts can increase the risk or severity of injury in an accident.

Additionally, your vehicle is equipped with an Occupant Detection System (ODS) in the front passenger's seat. The ODS detects the presence of a passenger in the front passenger's seat and will turn off the front passenger's air bag under certain conditions. For more detail, refer to "Occupant Detection System (ODS)" on page 4-38.

### **⚠ WARNING**

Modification to the seat structure can cause the air bag to deploy at a different level than should be provided.

Manufacturers are required by government regulations to provide a contact point concerning modifications to the

vehicle for persons with disabilities, which modifications may affect the vehicle's advanced air bag system. That contact is Kia's toll-free Customer Experience Department at 1-877-KIA-AUTO (1-877-542-2886). However, Kia does not endorse nor will it support any changes to any part or structure of the vehicle that could affect the advanced air bag system, including the ODS.

**⚠ WARNING**

**Replacement/modifications**

The front passenger seat, dashboard or door should not be replaced except by an authorized Kia dealer using original Kia parts designed for this vehicle and model. Any other such replacement or modification could adversely affect the operation of the Occupant Detection System and your advanced air bags.

Advanced air bags are combined with pre-tensioner seat belts to help provide enhanced occupant protection in frontal crashes. Front air bags are not intended to deploy in collisions in which sufficient protection can be provided by the seat belt.

**\* NOTICE**

Air bags can only be used once - have an authorized Kia dealer replace the air bag immediately after deployment.

Front air bags are not intended to deploy in side-impact, rear-impact or rollover crashes. However, when frontal deployment threshold is satisfied at side-impact, front air bags may deploy. In addition, front air bags will not deploy in frontal crashes below the deployment threshold.

**⚠ WARNING**

**SRS Wiring**

Do not tamper with or disconnect SRS wiring or other components of the SRS system. Doing so could result in injury, due to accidental deployment of the air bags or by rendering the SRS inoperative.

**⚠ WARNING**

**No attaching objects**

No objects (such as crash pad cover, cellular phone holder, cup holder, perfume or stickers) should be placed over or near the air bag modules on the steering wheel, instrument panel, windshield glass, and the front passenger's panel above the glove box. Such objects could cause harm if the vehicle is in a crash severe enough to cause the air bags to deploy.

Do not place any objects over the air bag or between the air bag and yourself.

Additionally, never place or insert any object into any small opening near side airbag labels attached to the vehicle seats.

When the air bag deploys, the object may affect the deployment and result in unexpected accident or bodily harm.

## Side air bag

Your vehicle is equipped with a side air bag in each front seat.

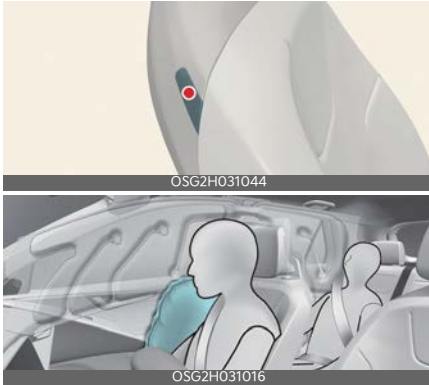

\* The actual air bags in the vehicle may differ from the illustration.

The purpose of the air bag is to provide the vehicle's driver and/or the front passenger with additional protection than that offered by the seat belt alone.

- The side air bags are designed to deploy during certain side-impact collisions, depending on the crash severity of impact.
- The side air bags may deploy on the side of the impact or on both sides.
- The side and/or curtain air bags on both sides of the vehicle will deploy if a rollover or possible rollover is detected.
- The side air bags are not designed to deploy in all side impact or rollover situations.

### **⚠ WARNING**

#### Unexpected deployment

Avoid impact to the side impact airbag sensor when the ENGINE START/STOP button is ON to prevent unexpected deployment of the side air bag.

- The side air bag is supplemental to the driver's and the passenger's seat belt systems and is not a substitute for them. Therefore your seat belts must be worn at all times while the vehicle is in operation.
- For best protection from the side air bag system and to avoid being injured by the deploying side air bag, both front seat occupants should sit in an upright position with the seat belt properly fastened. The driver's hands should be placed on the steering wheel at the 9:00 and 3:00 positions. The passenger's arms and hands should be placed on their laps.

### **⚠ WARNING**

#### Deployment

Do not install any accessories including seat covers, on the side or near the side air bag as this may affect the deployment of the side air bags.

- If the seat or seat cover is damaged, have the vehicle checked and repaired by an authorized Kia dealer. Inform the dealer that your vehicle is equipped with side air bags and an Occupant Detection System (ODS).

### **⚠ WARNING**

#### Flying objects

Do not place any objects (an umbrella, bag, etc.) between the front door and the front seat. Such objects may become dangerous projectiles if the side airbag inflates.

**⚠ WARNING**

**No attaching objects**

- Do not place any objects over the air bag or between the air bag and yourself. Also, do not attach any objects around the area the air bag inflates such as the door, side door glass, front and rear pillar.
- Do not put any objects between the side airbag label and seat cushion. It could cause harm if the vehicle is in a crash severe enough to cause the air bags to deploy.
- Never place or insert any object into any small opening near side airbag labels attached to the vehicle seats. When the air bag deploys, the object may affect the deployment and result in unexpected accident or bodily harm.
- Do not install any accessories on the side or near the side air bags.

**Curtain air bag**

Curtain air bags are located along both sides of the roof rails above the front and rear doors.

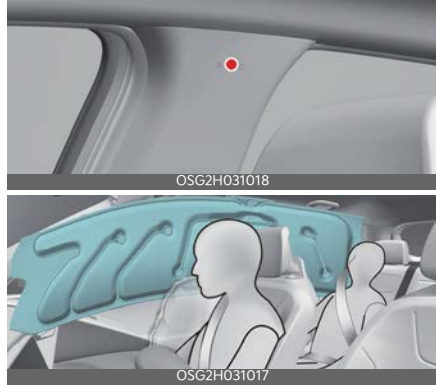

\* The actual air bags in the vehicle may differ from the illustration.

They are designed to help protect occupants in certain side impacts and to help prevent them from ejecting out of the vehicle as a result of a rollover, especially when the seatbelts are also in use.

- The curtain air bags are designed to deploy during certain side impact collisions, depending on the severity of impact. However, when side deployment threshold is satisfied at front-impact, side air bags may deploy.
- The curtain air bags may deploy on the side of the impact or on both sides.
- Also, the curtain air bags on both sides of the vehicle will deploy in certain rollover situations.
- The curtain air bags are not designed to deploy in all side impact or rollover situations.

Do not allow the passengers to lean their heads or bodies against the doors, put their arms on the doors, stretch their

arms out of the window or place objects between the doors and passengers when they are seated on seats equipped with side impact and/or curtain air bags.

### \* NOTICE

Never try to open or repair any components of the side and curtain air bag system. This should only be done by an authorized Kia dealer.

### ⚠ WARNING

#### No attaching objects

- Do not place any objects over the air bag. Also, do not attach any objects around the area the air bag inflates such as the door, side door glass, front and rear pillar, roof side rail.
- Do not hang hard, breakable, or heavy objects on the coat hooks for safety reasons.

## Air bag collision sensors



1



OSG2H031020

2



OSG2H031021

3



OSG2H031022

4



OSG2H031023

\* The actual shape and position of sensors may differ from the illustration.

1. Supplemental Restraint System (SRS) control module/rollover sensor
2. Front impact sensors
3. Side pressure sensors (front door)
4. Side impact sensors (B-pillar)

**WARNING**

**Air bag sensors**

- Do not hit or allow any objects to impact the locations where air bags or sensors are installed.  
This may cause unexpected air bag deployment, which could result in serious personal injury or death.
- If the installation location or angle of the sensors is altered in any way, the air bags may deploy when they should not or they may not deploy when they should.  
Therefore, do not try to perform maintenance on or around the air bag sensors. Have the vehicle checked and repaired by an authorized Kia dealer.
- Do not arbitrarily touch the front impact sensor. When the angle of the sensor is changed, the air bag system may malfunction.

Problems may arise if the sensor installation angles are changed due to the deformation of the front bumper, front end module, body or front doors where side collision sensors are installed. Have the vehicle checked and repaired by an authorized Kia dealer.

Installing bumper guards (or side step or running board) or replacing a bumper (or front door module) with non-genuine parts may adversely affect your vehicle's collision and air bag deployment performance.

Kia Genuine bumper guards/bumpers are parts we guarantee for quality and performance.

**Why didn't my air bag go off in a collision? (Inflation and non-inflation conditions of the air bag)**

There are many types of accidents in which the air bag would not be expected to provide additional protection.

These include rear impacts, second or third collisions in multiple impact accidents, as well as low speed impacts.

**Air bag inflation conditions**

**Front air bags**



Front air bags are designed to inflate in a frontal collision depending on several factors, including the severity of impact of the front collision.

**Side and curtain air bags**



\* The actual air bags in the vehicle may differ from the illustration.

Side and/or curtain air bags are designed to inflate when an impact is detected by side collision sensors depending on several factors, including the severity of impact resulting from a side impact collision.

Also, the side and curtain air bags are designed to inflate when a rollover is detected by a rollover sensor.

Although the front air bags (driver's and front passenger's air bags) are primarily designed to inflate in frontal collisions, they may inflate in other types of collisions if the front impact sensors detect a sufficient frontal force in another type of impact.

Similarly, although side and curtain air bags are designed to inflate in certain side impact collisions, they may inflate in other types of collisions where a side force is detected by the sensors. For instance, side air bag and/or curtain air bags may inflate if rollover sensors indicate the possibility of a rollover occurring (even if none actually occurs) or in other situations, including when the vehicle is tilted while being towed.

Even if side and/or curtain air bags do not provide impact protection in a rollover, they will deploy to prevent ejection of occupants, especially those who are restrained with seat belts.

If the vehicle chassis is impacted by bumps or objects on unimproved roads, the air bags may deploy. Drive carefully on unimproved roads or on surfaces not designed for vehicle traffic to prevent unintended air bag deployment.

### Air bag non-inflation conditions

- Air bags may not deploy in certain low-speed collisions where the air bag would not add any benefit beyond the protection already offered by the seat belts.



- Front air bags are not designed to inflate in rear collisions, because occupants are moved backward by the force of the impact. In this case, inflated air bags would not be able to provide any additional benefit.



- Front airbags may not inflate in side impact collisions, because passengers move in the direction of the collision. Thus, in side impacts, frontal airbag deployment would not provide additional occupant protection.



- In an angled collision, the force of impact may direct the occupants in a direction where the air bags would not be able to provide any additional ben-



## Safety features of your vehicle

efit, and thus the sensors may not deploy any air bags.



- Just before impact, drivers often brake heavily. Such heavy braking lowers the front portion of the vehicle causing it to "ride" under a vehicle with a higher ground clearance. Air bags may not inflate in this "under-ride" situation because deceleration forces that are detected by sensors may be significantly reduced by such "under-ride" collisions.



- Front air bags may not inflate in all rollover accidents when the SRS Control Module (SRSCM) indicates that the front air bag deployment would not provide additional occupant protection.

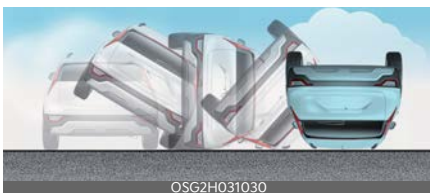

- Airbags may not inflate if the vehicle collides with an object such as a utility pole or tree. This is because the point of impact is concentrated in one area

## Air bag - advanced Supplemental Restraint System

and the full force of the impact is not delivered to the sensors.



## Supplemental Restraint System (SRS) care

The Supplemental Restraint System (SRS) is virtually maintenance-free and so there are no parts you can safely service by yourself.

If the SRS air bag warning light does not appear, or continuously remains on, have your vehicle immediately inspected by an authorized Kia dealer.

Any work on the SRS, such as removing, installing, repairing, or any work on the steering wheel, the front passenger's panel, front seats and roof rails must be performed by an authorized SRS dealer. Improper handling of the SRS may result in serious personal injury.

For cleaning the air bag pad covers, use only a soft, dry cloth or one which has been moistened with plain water. Solvents or cleaners could adversely affect the air bag covers and proper deployment of the system.

If components of the air bag system must be discarded, or if the vehicle must be scrapped, certain safety precautions must be observed. An authorized Kia dealer knows these precautions and can give you the necessary information. Failure to follow these precautions and procedures could increase the risk of bodily injury.

**⚠ WARNING****Tampering with SRS**

Do not tamper with or disconnect SRS wiring or other components of the SRS system. Doing so could result in the accidental inflation of the air bag or render the SRS inoperative.

**⚠ WARNING****Towing vehicle**

Always have the ignition off and wait for 3 minutes when your vehicle is being towed. The side air bags may inflate if the vehicle is tilted such as when being towed because of the rollover sensors in the vehicle.

**Additional safety precautions**

- **Never let passengers ride in the cargo area or on top of a folded-down back seat.** All occupants should sit upright, fully back in their seats with their seat belts on and their feet on the floor.
  - **Passengers should not move out of or change seats while the vehicle is moving.** A passenger who is not wearing a seat belt during a crash or emergency stop can be thrown against the inside of the vehicle, against other occupants, or out of the vehicle.
  - **Each seat belt is designed to restrain one occupant.** If more than one person uses the same seat belt, they could be seriously injured or killed in a collision.
  - **Do not use any accessories on seat belts.** Devices claiming to improve occupant comfort or reposition the seat belt can reduce the protection provided by the seat belt and increase the chance of serious injury in a crash.
- **Passengers should not place hard or sharp objects between themselves and the air bags.** Carrying hard or sharp objects on your lap or in your mouth can result in injuries if an air bag inflates.
  - **Keep occupants away from the air bag covers.** All occupants should sit upright, fully back in their seats with their seat belts on and their feet on the floor. If occupants are too close to the air bag covers, they could be injured if the air bags inflate.
  - **Do not attach or place objects on or near the air bag covers.** Any object attached to or placed on the front or side air bag covers could interfere with the proper operation of the air bags.
  - **Do not modify the front seats.** Modification of the front seats could interfere with the operation of the supplemental restraint system sensing components or side air bags.
  - **Do not place items under the front seats.** Placing items under the front seats could interfere with the operation of the supplemental restraint system sensing components and wiring harnesses.
  - **Never hold an infant or child on your lap.** The infant or child could be seriously injured or killed in the event of a crash. All infants and children should be properly restrained in appropriate child safety seats or seat belts in the rear seat.

**⚠ WARNING**

- Sitting improperly or out of position can cause occupants to be shifted too close to a deploying air bag, strike the interior structure or be thrown from the vehicle resulting in serious injury or death.
- Always sit upright with the seatback in an upright position, centered on the seat cushion with your seat belt on, legs comfortably extended and your feet on the floor.

**Adding equipment to or modifying your air bag-equipped vehicle**

If you modify your vehicle by changing your vehicle's frame, bumper system, front end or side sheet metal or ride height, this may affect the operation of your vehicle's air bag system.

**Air bag warning labels**

Air bag warning labels, some required by the Canada Motor Vehicle Safety Standards (CMVSS), are attached to the sun visor to alert the driver and passengers of potential risks of the air bag system.





# Features of your vehicle **5**

<b>Keys</b> .....	<b>5-6</b>
• Using the remote key .....	5-6
• Smart key.....	5-6
• Battery replacement .....	5-10
<b>Immobilizer system</b> .....	<b>5-11</b>
• Folding key immobilizer system.....	5-11
• Limp home (override) procedure.....	5-12
• Smart key immobilizer system .....	5-12
<b>Theft-alarm system</b> .....	<b>5-14</b>
• Armed stage .....	5-14
• Theft-alarm stage .....	5-14
• Disarmed stage .....	5-15
<b>Door locks</b> .....	<b>5-16</b>
• With the smart key .....	5-16
• With the mechanical key.....	5-17
• Operating door locks from inside the vehicle .....	5-18
• Door lock/unlock features.....	5-20
• Manual door lock switch .....	5-20
• Child-protector rear door lock.....	5-20
• Rear Occupant Alert (ROA) System.....	5-21
<b>Digital Key 2 Touch</b> .....	<b>5-22</b>
• Digital Key 2 Touch (Smart Phone) .....	5-22
• Digital Key 2 Touch (Card Key) .....	5-26
• Personalized Profile and Vehicle Settings .....	5-29
• Used Vehicle/Digital Key 2 Touch Maintenance .....	5-32
• Limitations of the System.....	5-32
<b>Driver Position Memory System</b> .....	<b>5-33</b>
• Storing memory positions .....	5-33
• Recalling memory positions .....	5-33
• Driver position memory system reset.....	5-33
• Easy access function .....	5-34

# 5 Features of your vehicle

<b>Liftgate.....</b>	<b>5-35</b>
• Opening the liftgate.....	5-35
• Closing the liftgate .....	5-36
• Emergency liftgate safety release.....	5-36
<b>Power liftgate.....</b>	<b>5-37</b>
• Operating the power liftgate .....	5-39
• Setting the power liftgate.....	5-40
• Resetting the power liftgate.....	5-41
• Emergency liftgate safety release.....	5-41
<b>Smart Liftgate with Auto Open .....</b>	<b>5-42</b>
• How to use the Smart Liftgate with Auto Open .....	5-42
• How to deactivate the Smart Liftgate with Auto Open function using the smart key.....	5-43
• Detecting area .....	5-44
<b>Windows .....</b>	<b>5-45</b>
• Window opening and closing .....	5-46
• Power window lock button .....	5-48
<b>Hood .....</b>	<b>5-49</b>
• Opening the hood.....	5-49
• Hood open warning .....	5-49
• Closing the hood .....	5-50
<b>Fuel filler door.....</b>	<b>5-51</b>
• Opening the fuel filler door (hybrid vehicle).....	5-51
• Opening the fuel filler door (Plug-in hybrid vehicle).....	5-51
• Closing the fuel filler door .....	5-53
<b>Sunroof.....</b>	<b>5-56</b>
• Sunshade.....	5-56
• Tilt open/close .....	5-56
• Slide open/close .....	5-57
• Automatic reversal .....	5-57
• Resetting the sunroof.....	5-58

# Features of your vehicle **5**

• Sunroof open warning .....	5-59
<b>Steering wheel .....</b>	<b>5-59</b>
• Motor Driven Power Steering (MDPS) .....	5-59
• Tilt & telescopic steering wheel.....	5-60
• Heated steering wheel.....	5-61
• Horn .....	5-62
<b>Mirrors.....</b>	<b>5-62</b>
• Inside rear view mirror.....	5-62
• Outside rear view mirror .....	5-72
<b>Instrument cluster .....</b>	<b>5-75</b>
• Full LCD cluster .....	5-76
• Adjusting instrument cluster illumination .....	5-77
• Gauges.....	5-77
• Transmission shift indicator .....	5-81
<b>LCD display.....</b>	<b>5-82</b>
• LCD display modes.....	5-83
<b>LCD displays.....</b>	<b>5-92</b>
• Trip information (trip computer) .....	5-92
• Digital speedometer.....	5-95
• Service interval.....	5-95
• Range (Plug-in hybrid vehicle).....	5-95
• Energy flow .....	5-96
• LCD display messages.....	5-96
<b>Warning and indicator lights .....</b>	<b>5-102</b>
• Warning lights.....	5-102
• Indicator lights.....	5-108
<b>Head-Up Display (HUD).....</b>	<b>5-112</b>
• Head Up Display Information .....	5-112
• Head-Up Display Setting .....	5-113
<b>Lighting.....</b>	<b>5-113</b>

# 5 Features of your vehicle

• Battery saver function .....	5-113
• Headlamp delay function.....	5-113
• Daytime Running Light (DRL).....	5-114
• Lighting control.....	5-114
• Operating high beam .....	5-115
• Operating turn signals and lane change signals .....	5-116
• Operating front fog light .....	5-116
• High Beam Assist (HBA) .....	5-117
<b>Wipers and washers .....</b>	<b>5-119</b>
• Auto control.....	5-120
• Operating windshield washers .....	5-121
• Operating rear window wiper and washer switch .....	5-121
<b>Welcome system .....</b>	<b>5-122</b>
<b>Interior lights.....</b>	<b>5-123</b>
• Automatic turn off function.....	5-123
• Map lamp.....	5-123
• Room lamp .....	5-124
• Luggage room lamp .....	5-124
• Vanity mirror lamp .....	5-125
• Glove box lamp.....	5-125
<b>Climate control system .....</b>	<b>5-125</b>
• System operation.....	5-125
• Climate control air filter.....	5-127
• Checking the amount of air conditioner refrigerant and compressor lubricant.....	5-127
<b>Automatic climate control system.....</b>	<b>5-129</b>
• Using the infotainment/climate switchable controller control panel (For Type B) .....	5-131
• Heating and air conditioning automatically.....	5-132
• Heating and air conditioning manually.....	5-133
<b>Windshield defrosting and defogging.....</b>	<b>5-137</b>



# Features of your vehicle **5**

• Defogging inside windshield.....	5-138
• Defrosting outside windshield.....	5-138
• Auto defogging system .....	5-138
• Defroster .....	5-139
• Defogging logic.....	5-140
<b>Front glass heater.....</b>	<b>5-141</b>
<b>Storage compartment .....</b>	<b>5-141</b>
• Center console storage .....	5-141
• Glove box.....	5-142
<b>Interior features.....</b>	<b>5-142</b>
• Ambient lights.....	5-142
• Cup holder.....	5-142
• Seat warmer .....	5-143
• Air ventilation seat .....	5-144
• Sun visor.....	5-145
• USB charger .....	5-145
• AC inverter .....	5-146
• Power outlet .....	5-147
• Wireless smart phone charging system.....	5-147
• Coat hook .....	5-150
• Floor mat anchors.....	5-151
• Luggage board.....	5-151
• Luggage net holder.....	5-151
• Cargo security screen .....	5-152
<b>Exterior features.....</b>	<b>5-154</b>
• Roof rack.....	5-154
<b>Infotainment system .....</b>	<b>5-155</b>
• Using the infotainment/climate switchable controller.....	5-155
• Audio system.....	5-155
<b>Declaration of Conformity .....</b>	<b>5-159</b>

## Features of your vehicle

### Keys

#### Record your key number



The key code number is stamped on the key code tag attached to the key set. Should

you lose your keys, this number will enable an authorized Kia dealer to duplicate the keys easily. Remove the key code tag and store it in a safe place. Also, record the key code number and keep it in a safe and handy place, but not in the vehicle.

**⚠ WARNING**

#### Aftermarket keys

Use only Kia original parts for the ignition key in your vehicle. If an aftermarket key is used, the ignition switch or ENGINE START/STOP button may not return to ON after START. If this happens, the starter will continue to operate causing possible fire due to excessive current in the wiring.

**⚠ WARNING**

#### Never leave the keys in your vehicle

Leaving children unattended in a vehicle with the keys is dangerous even if the vehicle is ACC or ON position. Unattended children could press the ENGINE START/STOP button and may operate power windows or other controls, or even make the vehicle move, which could result in serious bodily injury or even death. Never leave the keys in your vehicle with unsupervised children, when the engine is running.

### Using the remote key (if equipped)

Type A



Type B



### Smart key (if equipped)

With a smart key, you can lock or unlock a door and even start the engine without inserting the key.

Type A



Type B



Type C



ONQ5031001

## Lock (1)

All doors are locked if the lock button is pressed. If all doors are closed, the hazard warning lights will blink and the chime will sound once to indicate that all doors are locked.

Also, if the lock button is pressed once more within 4 seconds, the hazard warning lights will blink and the chime will sound once to confirm that the door is locked.

However, if any door remains open, the hazard warning lights (and/or the chime) will not operate. But if all doors are closed after the lock button is pressed, the hazard warning lights will blink once.

## Unlock (2)

All doors are unlocked if the unlock button is pressed once. The hazard warning lights will blink twice to indicate that all doors are unlocked.

After pressing this button, the doors will lock automatically unless you open any door within 30 seconds.

If you attempt to lock or unlock the door by pressing the door lock/unlock button in any of the following states, the door will not be locked or unlocked.

- When you want to lock or unlock the door in the ACC or ON state.
- When you want to lock a door in a car with one or more doors open.

Depending on the vehicle, the driver can activate or deactivate the 2-press unlock setting function. For more information, refer to "User settings mode" on page 5-85

## \* NOTICE

If the smart key is inoperative due to exposure to water or liquids, it will not be covered by your manufacturer's vehicle warranty.

## Liftgate open (3) (if equipped)

The liftgate is opened if the button is pressed for more than 1 second.

## Panic alarm (4)

The horn sounds and the hazard warning lights blink for about 30 seconds if this button is pressed for more than 0.5 seconds. To stop the horn and lights, press any button on the transmitter.

## Remote start (5) (if equipped)

You can start the vehicle using the remote start button (5) of the smart key. To start the vehicle remotely:

- Lock the doors by pressing the door lock button (1) within 10 m (32 ft) distance from the vehicle.
- Press the remote start button for over 2 seconds within 4 seconds after locking the doors.

Press the remote start button once to turn off the vehicle.

If no further action for operating/driving the vehicle is taken, the vehicle will be turned off 10 minutes after starting the vehicle remotely.

While remote starting, the hazard warning lights blink 3 times. If you want to

stop the engine, press the Remote Start button (5) again.

### Remote smart parking assist (RSPA) (6, 7) (if equipped)

You can start the vehicle without inserting the key.

\* The Remote smart parking assist (RSPA) helps the drivers park their vehicle by using sensors to measure parking spaces and control the steering wheel, gear shift and vehicle speed to semi-automatically park the vehicle. With the smart key, the driver can move the vehicle forward or backward using the forward/ backward buttons (6, 7) on the smart key. For more information, refer to "Remote Smart Parking Assist (RSPA) (if equipped)" on page 6-172.

### Start-up

You can start the vehicle without inserting the key.

\* For more information, refer to "ENGINE START/STOP button (if equipped)" on page 6-11.

### Mechanical key

If the smart key does not operate normally, you can lock or unlock the door by using the mechanical key.



To remove the mechanical key, press and hold the release button (1) and remove the mechanical key (2).

To reinstall the mechanical key, put the key into the hole and push it until a "click" sound is heard.

### ⚠ WARNING

#### Smart key

Never leave the keys in your vehicle with unsupervised children. Leaving children unattended in a vehicle with a manual ignition key or a ENGINE START/STOP button is dangerous.

Children copy adults and they could place the key in the ignition switch or press the start button. The key would enable children to operate power windows or other controls, or even make the vehicle move, which could result in serious bodily injury or death.

### Smart key precautions

The smart key may not work if any of the following occur:

- The smart key is close to a radio transmitter such as a radio station or an airport which can interfere with normal operation of the smart key.
- The smart key is near a mobile two-way radio system or a cellular phone.

- Another vehicle's smart key is being operated close to your vehicle.

When the smart key does not work correctly, open and close the door with the mechanical key and contact an authorized Kia dealer.

If the smart key is in close proximity to your cell phone or smart phone, the signal from the smart key could be blocked by normal operation of your cell phone or smart phone. This is especially important when the phone is active, such as when making calls, receiving calls, text messaging, and/or sending/receiving emails. Avoid placing the smart key and your cell phone or smart phone in the same pants or jacket pocket and maintain adequate distance between the two devices.

### \* NOTICE

#### Loss of the smart key

A maximum of 2 smart keys can be registered to a single vehicle.

If you happen to lose your smart key, you will not be able to start the vehicle. You should immediately take the vehicle and remaining key to your authorized Kia dealer (tow the vehicle, if necessary) to protect it from potential theft.

### ▲ CAUTION

#### Transmitter

Keep the transmitter away from water or any liquid, as it can become damaged and not function properly.

### \* NOTICE

If the smart key is inoperative due to exposure to water or liquids, it will not be covered by your manufacturer's vehicle warranty.

### \* NOTICE

To prevent the electronic key from becoming damaged by magnetic fields, do not leave it near the following electrical appliances:

- TVs
- Personal computers
- Cellular phones, cordless phones and battery chargers
- Table lamps
- Induction cookers

### \* NOTICE

If you have to leave the vehicle's key with a parking attendant, remove the mechanical key for your own use and provide the attendant with the electronic key only.

### \* NOTICE

When bringing a smart key onto an airplane, make sure you do not press any button on the key while inside the cabin. If you are carrying the key in your bag etc., make sure that the buttons cannot be pressed accidentally. If you press a button, the key may emit radio waves that could interfere with the operation of the aircraft.

## Battery replacement

The smart key uses a 3 volt lithium battery which will normally last for several years.



If you are unsure how to use or replace the battery, contact an authorized Kia dealer.

1. Detach mechanical key from your smart key.
2. Pry open the key cover.
3. Replace the smart key cover with a new battery. (CR2032) When replacing the battery, make sure the battery position is correct.
4. Install the battery in the reverse order of removal.

For smart key replacement, visit an authorized Kia dealer.

The smart key is designed to give you years of trouble-free use, however it can malfunction if exposed to moisture or static electricity. If you are unsure how to use or replace the battery, contact an authorized Kia dealer.

Using the wrong battery can cause smart key to malfunction. Be sure to use the correct battery.



An inappropriately disposed battery can be harmful to the environment and human health. Dispose the battery according to your local law(s) or regulation.

### **⚠ WARNING**

#### **THIS PRODUCT CONTAINS A BUT-TON BATTERY**

If swallowed, a lithium button battery can cause severe or fatal injuries within 2 hours.

Keep batteries out of reach of children.

If you think batteries may have been swallowed or placed inside any part of the body, seek immediate medical attention.

### **⚠ CAUTION**

#### **Smart key damage**

The smart key can malfunction if dropped, exposed to moisture, static electricity, heat or direct sunlight.

### **⚠ WARNING**

#### **IC WARNING**

This device complies with Industry Canada licence-exempt RSS standard(s).

Operation is subject to the following two conditions:

1. This device may not cause interference.
2. This device must accept any interference, including interference that may cause undesired operation of the device.

#### **This device complies with Industry Canada licence-exempt RSS standard(s).**

Operation is subject to the following two conditions:

1. This device may not cause interference, and
2. This device must accept any interference, including interference that may

cause undesired operation of the device.

### \* NOTICE

Changes or modifications not expressly approved by the party responsible for compliance could void the user's authority to operate the equipment. If the smart key is inoperative due to changes or modifications not expressly approved by the party responsible for compliance, it will not be covered by your manufacturer's vehicle warranty.

## Immobilizer system

### Folding key immobilizer system

Your immobilizer system is comprised of a small transponder in the key and electronic devices inside the vehicle.

With the immobilizer system, whenever you insert and turn your remote key to the ON position, or press ENGINE START/STOP button to ON position, it checks and determines and verifies that the key is valid.

If the key is determined to be valid, the engine will start.

If the key is determined to be invalid, the engine will not start.

### Deactivating the Folding Key Immobilizer system

Insert the ignition key into the key cylinder and turn it to the ON position.

### Activating the Folding Key Immobilizer system

Turn the ignition key to the OFF position. The immobilizer system activates automatically. Without a valid ignition key for your vehicle, the engine will not start.

Your Immobilizer password is a customer unique password and should be kept confidential. Do not leave this number anywhere in your vehicle.

### \* NOTICE

Keep each key separately in order to avoid a starting malfunction.

### \* NOTICE

In order to prevent theft of your vehicle, do not leave spare keys anywhere in your vehicle. Your immobilizer password is a customer unique password should

be kept confidential. Do not leave this number anywhere in your vehicle.

### \* NOTICE

- Do not put metal accessories near the ignition switch.
- Metal accessories may interrupt the transponder signal and may prevent the engine from being started.

### \* NOTICE

If you need additional keys or lose your keys, consult an authorized Kia dealer.

### ⚠ CAUTION

#### Immobilizer damage

Do not expose your immobilizer system to moisture, static electricity or rough handling. This may damage your immobilizer.

### ⚠ CAUTION

#### Immobilizer alterations

Do not change, alter or adjust the immobilizer system because it could cause the immobilizer system to malfunction.

#### Limp home (override) procedure

When you turn the ignition switch to the ON position, if the immobilizer indicator () goes off after blinking 5 times, your transponder equipped in the ignition key is out of order. You cannot start the engine without the limp home procedure. To start the engine, you have to input your password by using the ignition switch. Your password is only available from an authorized Kia dealership. Contact an authorized dealer for more information.

The following procedure is how to input your password of

1. Turn the ignition switch to the ON position. The immobilizer indicator () will blink 5 times and go off indicating the beginning of the limp home procedure.
2. Turn the ignition switch to the ACC position.
3. To enter the first digit (in this example "2"), turn the ignition switch to the ON and ACC position twice. Perform the same procedure for the next digits between 3 seconds and 10 seconds. (for example, for "3", turn the ignition ON and ACC 3 times)
4. If all of the digits have been input successfully, you have to start the engine within 30 seconds. If you attempt to start the engine after 30 seconds, the engine will not start and you will have to input your password again.

After performing the limp home procedure, you have to see an authorized Kia dealer immediately to inspect and repair your ignition key or immobilizer system.

#### Smart key immobilizer system (if equipped)

The immobilizer system protects your vehicle from theft. If an improperly coded key (or other device) is used, the vehicle's power system is disabled.

When the ENGINE START/STOP button is placed in the ON position, the immobilizer system indicator should come on briefly, then go off. If the indicator starts to blink, the system does not recognize the coding of the key.

Place the ENGINE START/STOP button in the OFF position, then place the ENGINE START/STOP button in the ON position again.



In some circumstances, the vehicle may not recognize your smart key if another smart key device is nearby or a metal object such as a key chain is causing interference with the smart key.

If this occurs, your vehicle may not start. Remove any metal objects or additional keys near the smart key before attempting to start the vehicle again.

If the system repeatedly does not recognize the coding of the key, contact your Kia dealer.

Do not attempt to alter this system or add other devices to it. Electrical problems could result that may make your vehicle inoperable.

### Deactivating the Smart Key Immobilizer system

Change the ENGINE START/STOP button to the ON position.

### Activating the Smart Key Immobilizer system

Change the ENGINE START/STOP button to the OFF position. The immobilizer system activates automatically. Without a valid smart key for your vehicle, the engine will not start.

#### \* NOTICE

When starting the vehicle, do not use the key with other immobilizer keys around. Otherwise, the vehicle may not start or may stop soon after it starts. Keep each key separate in order to avoid a starting malfunction.

#### \* NOTICE

If you need additional keys or lose your keys, contact an authorized Kia dealer.

### This device complies with Industry Canada licence-exempt RSS standard(s).

Operation is subject to the following two conditions:

1. This device may not cause interference, and
2. This device must accept any interference, including interference that may cause undesired operation of the device.

#### \* NOTICE

Changes or modifications not expressly approved by the party responsible for compliance could void the user's authority to operate the equipment. If the smart key is inoperative due to changes or modifications not expressly approved by the party responsible for compliance, it will not be covered by your manufacturer's vehicle warranty.

## Theft-alarm system

This system is designed to provide protection from unauthorized entry into the vehicle.

This system is operated in three stages:

- 1 Armed stage
- 2 Theft-alarm stage
- 3 Disarmed stage

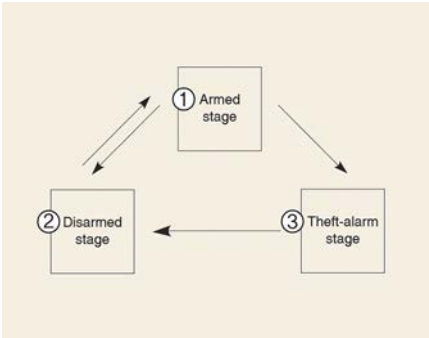

If triggered, the system provides an audible alarm with blinking of the hazard warning lights.

### ⚠ CAUTION

Do not attempt to alter this system or add other devices to it.

## Armed stage

### Using the smart key

Park the vehicle and stop the engine. Arm the system as described below.

1. Turn off the engine.
2. Make sure that all doors, the hood and liftgate are closed and latched.
3. Lock the doors by pressing the button of the front outside door handle with the smart key in your possession. After completion of the steps above, the hazard warning lights will operate once to indicate that the system is

armed. If any door (or liftgate) or hood remains open, the hazard warning lights and the chime will not operate and the theft-alarm will not arm. If all doors and liftgate and hood are closed after the lock button is pressed, the hazard warning lights blink once. The system can also be armed by locking the doors with the key from the front doors; however, the hazard warning lights will not blink using this method.

4. Lock the doors by pressing the lock button on the smart key. After completion of the steps above, the hazard warning lights will operate once to indicate that the system is armed.

### \* NOTICE

The theft-alarm system can be deactivated by an authorized Kia dealer. If you want this feature, consult an authorized Kia dealer.

### \* NOTICE

Do not arm the system until all passengers have left the vehicle. If the system is armed while a passenger(s) remains in the vehicle, the alarm may be activated when the remaining passenger(s) leaves the vehicle. If any door (or liftgate) or hood is opened within 30 seconds after the system enters the armed stage, the system will be disarmed to prevent unnecessary alarm.

## Theft-alarm stage

The alarm will be activated if any of the following occurs while the system is armed.

- A front or rear door is opened without using the smart key.

- The liftgate is opened without using the smart key.
- The hood is opened.

The horn will sound and the hazard warning lights will blink continuously for approximately 27 seconds, and repeat the horn 3 times unless the system is disarmed. To turn off the system, unlock the doors with the folding key or smart key.

### Disarmed stage

The system will be disarmed when:

### Using the remote key

- The door unlock button is pressed.
- The engine is started.
- The vehicle is in the "ON" position for 30 seconds or more.

### Using the smart key

- The door unlock button is pressed.
- The button of the front outside door is pressed while carrying the smart key.
- The engine is started. (within 3 seconds)

After pressing the unlock button, the hazard warning lights will blink and the chime will sound twice (in smart key) to indicate that the system is disarmed.

After pressing the unlock button, if any door (or liftgate) is not opened within 30 seconds, the system will be rearmed.

#### \* NOTICE

- Avoid trying to start the engine while the alarm is activated. The vehicle starting motor is disabled during the theft-alarm stage.

If the system is not disarmed with the folding key, insert the key into the ignition switch, turn the ignition switch

to the ON position and wait for 30 seconds. Then the system will be disarmed.

- If you lose your keys, consult your authorized Kia dealer.

#### ⚠ CAUTION

### Adjusting alarm system

Do not change, alter or adjust the theft alarm system in your vehicle. Improper installation of the alarm system could damage the vehicle or cause the system to malfunction.

#### \* NOTICE

Malfunctions caused by improper alterations, adjustments or modifications to the theft-alarm system are not covered by your vehicle manufacturer warranty.

### This device complies with Industry Canada licence-exempt RSS standard(s).

Operation is subject to the following two conditions:

1. This device may not cause interference, and
2. This device must accept any interference, including interference that may cause undesired operation of the device.

#### \* NOTICE

Changes or modifications not expressly approved by the party responsible for compliance could void the user's authority to operate the equipment. If the smart key is inoperative due to changes or modifications not expressly approved by the party responsible for compliance,

it will not be covered by your manufacturer's vehicle warranty.

---

## Door locks

Know how to use the door lock so that you can lock or unlock the door if necessary.

### With the smart key



Carrying the smart key, you may lock and unlock the vehicle doors (and liftgate). Also, you may start the engine. Refer to the following for more details.

### Locking

Pressing the button of the front driver side door handles with all doors closed and any door unlocked, locks all the doors. If all doors and engine hood are closed, the hazard warning lights will blink once to indicate that all doors are locked.

The button will only operate when the smart key is within 0.7 ~ 1 m (28 ~ 40 inches) from the driver side door handle. If you want to make sure that a door has locked or not, you should pull the driver side door handle.

Even though you press the driver side door handle buttons, the doors will not lock and the chime will sound for 3 seconds if any of following occur:

- The smart key is in the vehicle.
- The ignition switch or ENGINE START/STOP button is in the ACC or ON position.
- Any door except the liftgate is open.

## Unlocking

Pressing the button of the front driver side door handles with all doors closed and locked, unlocks all the doors. The hazard warning lights blink twice to indicate that all doors are unlocked.

The button will only operate when the smart key is within 0.7 ~ 1 m (28 ~ 40 inches) from the front driver side door handle.

When the smart key is recognized in the area of 0.7 ~ 1 m (28 ~ 40 inches) from the front driver side door handle, other people can also open the door without possession of the smart key.

After pressing the button, the doors will lock automatically unless you open any door within 30 seconds.

## With the mechanical key



1. Pull out the door handle.
  2. Press the lever (1) located inside the bottom part of the cover with a key or flat-head screwdriver.
  3. Push out the cover (2) while pressing the lever (only the driver's door can be locked/unlocked).
  4. Turn the key toward the rear of the vehicle to unlock and toward the front of the vehicle to lock. Only the driver's door can be locked or unlocked.
- Doors can also be locked and unlocked with the transmitter.
  - Once the doors are unlocked, they may be opened by pulling the door handle.

- When closing the door, push the door by hand. Make sure the doors are closed securely.

### \* NOTICE

- When locking the door with a mechanical key, be aware that only the driver's door can be locked/unlocked.
- To lock all doors, operate the central lock switch inside the vehicle. Open the car door using the inner handle, then close the door and lock the driver's door with a mechanical key.
- Refer to "Operating door locks from inside the vehicle" on page 5-18 to lock from inside the vehicle.

### \* NOTICE

- Be careful not to lose or scratch the cover when removing it.
- When the key cover freezes and does not open, tap it lightly or indirectly warm (hand temperature, etc.) it up.
- Do not apply excessive force to the door and door handle. It may be damaged.

### \* NOTICE

- In cold and wet climates, door lock and door mechanisms may not work properly due to freezing conditions.
- If the door is locked/unlocked multiple times in rapid succession with either the vehicle key or door lock switch, the system may stop operating temporarily in order to protect the circuit and prevent damage to system components.

**⚠ WARNING**

- Securely close your door before you begin driving. Failure to fully close your door may cause it to be opened during vehicle operation.
- Keep your body out of the way of the closing door to prevent injuries.

**⚠ WARNING**

If any passengers must remain in the vehicle while it is very hot or cold outside, there is risk of injuries or danger to life. Do not lock the vehicle from the outside when there are passengers in the vehicle.

**⚠ CAUTION**

Do not unnecessarily open and close the door repeatedly or with excessive force. Such action can damage the vehicle door.

**\* NOTICE**

Always place the ignition switch or ENGINE START/STOP button in the OFF position, engage the parking brake, close all windows, and lock all doors when leaving your vehicle unattended.

- If you lock the door with the central door lock button, all vehicle doors will lock automatically.

**\* NOTICE**

Always remove the ignition key, engage the parking brake, close all windows, and lock all doors when leaving your vehicle unattended.

**Operating door locks from inside the vehicle**

You can operate door locks with the door lock handle or central door lock switch.

**With the door handle**

- Front door  
If the inner door handle is pulled when the door is locked, the door will unlock and open.
- Rear door  
If the inner door handle is pulled once when the door is locked, the door will unlock.  
If the inner door handle is pulled once more, the door will open.

**Door lock malfunction**

If a power door lock ever fails to function while you are in the vehicle, try one or more of the following techniques to exit:

- Operate the door unlock feature repeatedly (both electronic and manual) while simultaneously pulling on the door handle.
- Operate the other door locks and handles, front and rear.
- Lower a front window and use the key to unlock the door from outside.
- Move to the cargo area and open the liftgate.

**⚠ WARNING**

Do not pull the inner door handle of driver's (or passenger's) door while the vehicle is moving.

**With central door lock switch**

Driver side



Passenger side



- 1 Door Lock
- 2 Door Unlock
- 3 Doors indicating light

Operate by pressing the central door lock switch.

- To lock all vehicle doors, press the central door lock switch (1) of driver and passenger side.
- To unlock all vehicle doors, press central door unlock switch (2) of driver and passenger side.

When all vehicle doors are locked, the indicating lights (3) on the driver's door and passenger's door will turn on. If any door is unlocked, it would go off.

Any door is opened, the doors will not lock even though the central door lock switch is pressed.

**⚠ WARNING****Doors**

- The doors should always be fully closed and locked while the vehicle is in motion to prevent accidental opening of the door. Locked doors will also discourage potential intruders when the vehicle stops or slows down.
- Be careful when opening doors and watch out for vehicles, motorcycles, bicycles or pedestrians approaching the vehicle in the path of the door. Opening a door when something is approaching can result in an accident to cause vehicle damage or serious injury.

**\* NOTICE****Unlocked vehicles**

Leaving your vehicle unlocked can increase the risk of vehicle theft or any possible criminal harm caused by someone hiding in your vehicle while you are gone. Always remove the ignition key, engage the parking brake, close all windows and lock all doors when leaving your vehicle unattended.

**⚠ WARNING****Unattended children, the elderly or pets**

An enclosed vehicle can become extremely hot, causing death or severe injury such as heatstroke to unattended children, the elderly or pets who cannot escape the vehicle. When left or trapped in a hot vehicle, make sure to stay hydrated and avoid sun exposure through the vehicle's windshield. Furthermore, children might operate features of the vehicle that could injure them, or they could encounter other

harm, possibly from someone gaining entry to the vehicle. Never leave children or animals unattended in your vehicle.

### Door lock/unlock features

The vehicle is equipped with door lock/unlock features for the safety and convenience of passengers.

### Impact sensing door unlock system

All doors will automatically unlock when an impact causes the air bags to deploy.

### Speed sensing door lock system

All doors will automatically lock after the vehicle speed exceeds 15 km/h (10 mph).

You can activate or deactivate the auto door lock/unlock features in the vehicle. Refer to "User settings mode" on page 5-85.

### Manual door lock switch

If the electrical power door lock switch is not operating (e.g., dead car battery) the only way to lock the door(s) is with the mechanical key from the outside key hole.

Doors without an outside key hole can be locked as follows:

1. Open the door.
2. Insert the key into the door lock hole and turn the key to the lock position as shown.



3. Close the door securely.

### \* NOTICE

If the electrical power to door lock switch is not operating (e.g., dead car battery) and the liftgate is closed, you will not be able to open the liftgate until power is restored.

### Child-protector rear door lock

The child safety lock is provided to help prevent children from accidentally opening the rear doors from inside the vehicle.

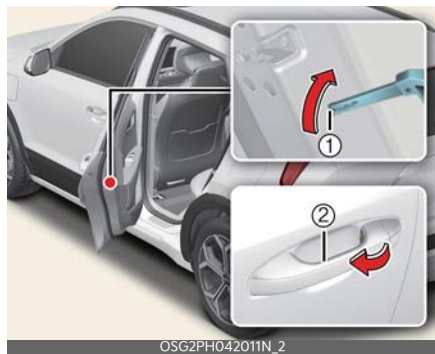

The rear door safety locks should be used whenever children are in the vehicle.

The child safety lock is located on the edge of each rear door. When the child safety lock is in the lock position (1), the rear door will not open if the inner door handle is pulled.

To lock the child safety lock, insert a key (or screwdriver) into the hole and turn it to the lock position.

To allow a rear door to be opened from inside the vehicle, unlock the child safety lock.

To open the rear door, pull the outside door handle (2).



**⚠ WARNING**

**Rear door locks**

If children accidentally open the rear doors while the vehicle is in motion, they could fall out and be severely injured or killed. To prevent children from opening the rear doors from the inside, the rear door safety locks should be used whenever children are in the vehicle.

**⚠ WARNING**

- The system does not detect every obstacle approaching the vehicle exit.
- The driver and passenger are responsible for the accident occurred while exiting the vehicle. Always check the surrounding before you exit the vehicle.

**Rear Occupant Alert (ROA) System**

The Rear Occupant Alert (ROA) is provided to help prevent exiting the vehicle with a rear passenger left in the vehicle.

- When you open the front door after opening and closing the rear door and turning off the engine, the "Check rear seats" warning message appears on the cluster.

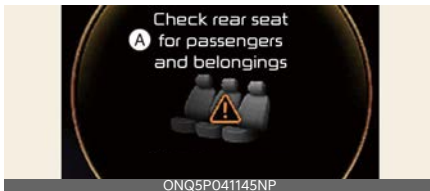

**A: Check rear seat for passengers and belongings**

You can activate or deactivate the ROA from the User Settings mode in the cluster LCD display. If your vehicle is equipped with an infotainment system,

you can learn how to setup on the website via QR code in the infotainment quick reference guide.

The option can be found under the following menu:

1. Press the MODE button (⏏) several times on the steering wheel until 'User Settings' menu appears on the LCD.
2. Select '**Convenience → Rear Occupant Alert**' with the MOVE switch (↙ / ↘) and the OK button on the steering wheel.

If your vehicle is equipped with the infotainment system, the option can be found under the following menu:

1. Press the SETUP button of the infotainment system.
2. Press '**Vehicle → Convenience → Rear Occupant Alert**' on the infotainment system screen.

**⚠ WARNING**

The Rear Occupant Alert (ROA) system does not actually detect objects or people in the rear seat. By using a rear door opened and closed history, the system informs the driver that there may be something in the rear seat.

**⚠ CAUTION**

- The Rear Occupant Alert (ROA) system uses a rear door opened and closed history.
- The history is reset after the vehicle is in OFF position, exits the vehicle and locks the door remotely. So even if a rear door does not reopen, the ROA system alert can occur.
- For example, after the ROA system alert occurs, if the driver does not lock

the door, and drives again, the alert can occur.

### \* INFORMATION

The infotainment system may change after software updates. For more information, refer to the user's manual provided in the infotainment system and the quick reference guide.

## Digital Key 2 Touch

Digital Key 2 Touch provides convenience to the driver, which the driver can use to lock or unlock the driver and passenger doors or the liftgate and turn on the vehicle.

### Digital Key 2 Touch (Smart Phone)

#### How to register Digital Key 2 Touch (Smart phone)

To use the smart phone as a digital key (smart phone) follow the following procedure.

The driver can confirm supported/compatible devices on our website.

Services are expected to be provided according to policy change.

#### Smart Phone Set Up

In order to use Digital Key 2 Touch (Smart phone) function, install Kia Access app on your smart phone and register your information.

For more details, please refer to Navigation Quick Reference Guide.

#### Smart Phone Registration

1. Turn the vehicle on with the Smart key and make sure to keep the smart key inside the vehicle during digital key registration.
2. With the vehicle on, touch **Setup** → **Vehicle** → **Digital Key** → **Smartphone Key** → **My Smartphone Key** on the infotainment system.



- 1) Smartphone Key
- 2) My Smartphone Key
- 3) Save

3. After pressing **Digital Key Settings** → **Register** on Kia Connect app, place the backside of the smart phone on the in-vehicle authentication pad.



[A]: Indicator, [B]: Charging pad

- As long as the device is supported from additional vehicle services, the Digital Key can be registered wirelessly.
4. Select **Save** menu on the instrument cluster or on the infotainment system screen. The saving process will begin automatically.
  5. When the digital key (smart phone) is saved, a message will appear on the instrument cluster or the infotainment system screen.
  6. Remove the smart phone from the pad and complete the saving process under the guidance of the smart phone screen.

**\* INFORMATION**

- The infotainment system may change after software updates. For more information, refer to the user's manual

provided in the infotainment system and the quick reference guide.

- Vehicle

When there is a digital key (smart phone) already saved in the vehicle, the **Save** menu is disabled. If you want to save a digital key again, refer to "How to delete Digital Key (Smart Phone)" on page 5-25 and follow the deleting procedure first before saving a digital key.

- Smart Phone
- The digital key cannot be saved again while the vehicle's digital key is saved in the owner's smart phone. Save the digital key after deleting the digital key from the Kia Connect App.
- During the digital key saving process, the process will cancel when:
    - The smart phone is removed from the in-vehicle authentication pad (wireless charging pad)
    - Changing the infotainment system or instrument cluster screen
    - The vehicle is turned off
    - The gear is shifted
    - There is no smart key (saving process will not begin)

**How to Use the Digital Key 2 Touch (Smart Phone)**

**Smart Phone touch control**

The driver can lock and unlock the door by touching the smart phone on the door handle without activating the Kia Connect App. Also, the vehicle can be started by placing the smart phone on the in-vehicle authentication pad (wireless charging pad).



[A]: Door handle authentication pad  
 [B]: NFC antenna (Backside of the smart phone) (The antenna position differs depending on models.)

**Locking/Unlocking the doors**

- If the driver touches the smart phone NFC antenna to the driver's or passenger's door handle authentication pad for more than 2 seconds, the door will lock or unlock.
- If 2 Press Unlock function is set, only the driver's door will be unlocked by touching the smart phone on the driver's door handle. Touch the smart phone once more within 4 seconds to unlock all doors.
- After unlocking the doors, the doors will automatically re-lock after 30 seconds unless a door is opened.
- If the smart phone digital key does not operate, move the smart phone more than 0.1 m (4 inches) from the door handle authentication pad and try it again.

**\* NOTICE**

Note that you cannot lock your vehicle using the smart phone NFC antenna if any of the following occur:

- The Smart Key is in the vehicle

- The ENGINE START/STOP button is in ACC or ON position
- Attempting to lock the door when more than one door, or hood, liftgate is opened.

**Starting the vehicle**

After placing your registered smart phone on the in-vehicle authentication pad (wireless charging pad), depress the brake pedal and press the ENGINE START/STOP button.

- Once the vehicle is started, you can remove the smart phone from the pad.

For more details, refer to "ENGINE START/STOP button (if equipped)" on page 6-11.

**⚠ WARNING**

The vehicle can be started when the registered smart phone is placed on the in-vehicle authentication pad (wireless charging pad). Therefore, do not leave unsupervised children or people who are not aware of the system since it can result in serious injury or death. In addition, always have the registered smart phone with you to prevent vehicle theft when leaving the vehicle.

**\* NOTICE**

The operation time of Digital Key 2 Touch for shared user may extend during first time use.

Approach your Digital Key 2 Touch (smartphone) on the authentication pad located in the outside door handle until the vehicle door lock/unlock function operates.

If the inner authentication pad is used for the first time, 1st vehicle start function may not operate.

## How to delete Digital Key (Smart Phone)

Turn the vehicle on with the smart key and make sure to keep the smart key inside the vehicle during the digital key (smart phone) deleting process.

### 1. Delete All digital Key (Smart Phone)



- 1) Digital Key
- 2) Smartphone Key
- 3) Delete All

With the vehicle on, touch **Setup** → **Vehicle** → **Digital Key** → **Smartphone Key** → **Delete All** on the infotainment system.

- The key of owner and the shared user will be deleted.
- If there is no registered key, the menu cannot be selected.

### 2. Delete My Smartphone Key

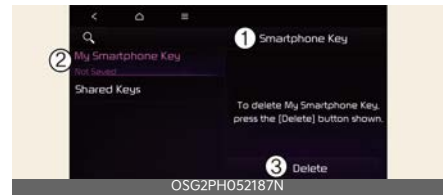

- 1) Smartphone Key
- 2) My Smartphone Key
- 3) Delete

If the owner's smart phone has been changed, the new smart phone can be registered after only deleting the previous Digital Key 2 Touch (Smart Phone).

With the vehicle on, touch **Setup** → **Vehicle** → **Digital Key** → **Smartphone Key** → **My Smartphone Key** → **Delete** on the infotainment system.

- If the shared key is registered in the vehicle, the shared key is not deleted.
- After deleting 'My Smartphone Key', the new smart phone can be registered.

### \* NOTICE

- If digital key (smart phone) is deleted, the digital key saved in the smart-phone is also deleted.
- If digital key (smart phone) is deleted on the smart phone, the digital key saved in the vehicle is also deleted.
- The function to delete shared user's key is not provided from the infotainment system.
- Digital key can be activated or deactivated within the Kia Access app provided from the smart phone manufacturer.

- Digital key can be managed within the Kia Connect app provided from the smart phone manufacturer.

**\* INFORMATION**

The infotainment system may change after software updates. For more information, refer to the user's manual provided in the infotainment system and the quick reference guide.

**Digital Key 2 Touch (Card Key)**

**How to register Digital Key 2 Touch (Card Key)**

To use the card key as a digital key, follow the following procedure.

1. Get in the vehicle with two smart keys.
2. Check if 'Enable Card Key' menu is activated.

With the vehicle on, touch **Setup** → **Vehicle** → **Digital Key** → **Card Key** → **Save** on the infotainment system.

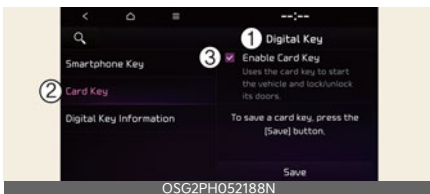

- 1) **Digital Key**
  - 2) **Card Key**
  - 3) **Enable Card Key**
3. With the vehicle on, place the card key on the in-vehicle authentication pad and press the **Save** menu on the infotainment system screen. The saving process will begin automatically.

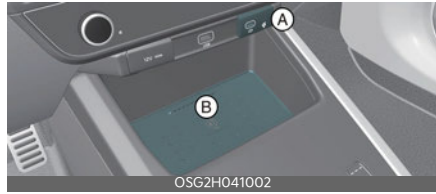

[A]: Indicator, [B]: Charging pad



- 1) **Digital Key**
  - 2) **Card Key**
  - 3) **Save**
4. When the digital key (card key) is saved, a message will appear on the infotainment system screen.

**\* INFORMATION**

- The infotainment system may change after software updates. For more information, refer to the user's manual provided in the infotainment system and the quick reference guide.
- When there is a digital key (card key) already saved in the vehicle, the **Save** menu is disabled. If you want to save a digital key again, refer to "How to delete Digital Key 2 Touch (Card key)" on page 5-28 and follow the deleting procedure first before saving a digital key.
- To register the digital key (card key), the two smart keys must be in the vehicle.
- The registered digital key (card key) cannot be used for another vehicle.

## How to use the Digital Key 2 Touch (Card key)

### Card key touch control

The driver can lock and unlock the door by touching the card key on the door handle. Also, the vehicle can be started by placing the card key on the in-vehicle authentication pad (wireless charging pad).



[A]: Door handle authentication pad,  
[B]: Card key NFC antenna

### Locking/Unlocking the doors

- If the driver touches the card key on the driver's or passenger's door handle authentication pad for more than 2 seconds, the door will lock or unlock.
- If 2 Press Unlock function is set, only the driver's door will be unlocked by touching the card key on the driver's door handle. Touch the card key once more within 4 seconds to unlock all doors.
- After unlocking the doors, the doors will automatically re-lock after 30 seconds unless a door is opened.

### \* NOTICE

When approaching smartphone NFC antenna to the outside door handle authentication pad, the doors will not lock with an audible warning in following conditions:

- The Smart Key is in the vehicle
- The ENGINE START/STOP button is in ACC or ON position
- Any of the doors are open except for the vehicle hood or liftgate

### Starting the vehicle

After placing your registered card key on the in-vehicle authentication pad (wireless charger pad), depress the brake pedal and press the ENGINE START/STOP button.

- Once the vehicle is started, you can remove the card key from the pad.

For more details, refer to "ENGINE START/STOP button (if equipped)" on page 6-11.

### ⚠ WARNING

The vehicle can be started when the registered card key is placed on the in-vehicle authentication pad (wireless charging pad). Therefore, do not leave unsupervised children or people who are not aware of the system since it can result in serious injury or death. In addition, always have the registered card key with you to prevent vehicle theft when leaving the vehicle.

### ⚠ CAUTION

- The digital key (card key) may not work under the following conditions:
  - The digital key (card key) is not touching the center of the door

handle authentication pad or in-vehicle authentication pad (wireless charging pad) correctly.

- The digital key (card key) is used overlapped with NFC-enabled cards such as credit card or smart phone.
- If the digital key (card key) does not work, move the card key approximately 10 cm (4 inches) away from the authentication pad and then touch it again.
- The digital key (card key) can be damaged by impacts. If the digital key (card key) is damaged, replace the digital key (card key) with a new one and register it again.
- Long-time exposure to high temperature may cause the card key to malfunction. Be careful not to expose the key to direct sunlight or high temperature.



- 1) **Digital Key**
  - 2) **Card Key**
  - 3) **Delete**
3. When the digital key (card key) is deleted, a message will appear on the infotainment screen or cluster.

## How to delete Digital Key 2 Touch (Card key)

1. Turn the vehicle on with the smart key and make sure to keep the smart key inside the vehicle during the digital key (card key) deleting process.
2. With the vehicle on, place the card key on the in-vehicle authentication pad. With the vehicle on, touch **Setup** → **Vehicle** → **Digital Key** → **Card Key** → **Delete** on the infotainment system. The **Delete** menu will be disabled if there if no digital key (card key) saved.



## \* INFORMATION

The infotainment system may change after software updates. For more information, refer to the user's manual provided in the infotainment system and the quick reference guide.

### Personalized Profile and Vehicle Settings (if equipped)

When the registered digital key is linked with user profile, the vehicle will automatically operate (door lock/unlock with digital key, etc.) according to the user profile setting. User profile linking and personalization are available for a total of two drivers.

### Linking / Unlinking profile

#### How to link user profile

1. Select **Setup** → **User Profile** → **Profile Setting** → **Link Digital Key (Smartphone)** on the infotainment system settings menu.
2. If you select **Link**, the registered phone number's digital key and the user profile will link. Select **Link** according to the instruction.
3. When the process is complete, the message 'Digital Key Link Complete.' will appear on the infotainment system screen.

#### How to unlink user profile

1. Unlink digital key in the User Profile settings. Unlinking is possible only when user profile is linked.
2. When unlinking is complete, the message 'Digital key is unlinked.' will appear on the infotainment system screen.

## \* INFORMATION

- The infotainment system may change after software updates. For more information, refer to the user's manual provided in the infotainment system and the quick reference guide.
- Use profile cannot be linked to both Driver 1 and Driver 2 that are connected to a single smart phone. Personalization will operate with the recently linked user profile, and the previously linked user profile will be automatically canceled.
- User profile can be linked when a digital key is registered on the smart phone and the vehicle. The smart phone with another vehicle's digital key cannot be linked.
- If you remove the smart phone from the in-vehicle authentication pad (wireless charging pad) before completing the user profile link, the linking process will not be completed normally.
- Once the user profile linked digital key in the smart phone is deleted, the digital key should be re-registered and personalized by linking the user profile again.
- NFC card key cannot be linked with personalized profile.

## Vehicle personalization operation

The personalization function linked with Digital Key 2 Touch works under the following conditions:

- Touch the driver's door handle with the profile linked smart phone to lock or unlock the doors (Personalization does not operate when locking or unlocking the front passenger door.).
- The personalization function using the digital key can be operated after linking the digital key in the infotainment system profile menu.
- The personalization function works only when the vehicle is OFF or when the vehicle is started remotely. If the vehicle is not started remotely, personalization function does not work with the digital key.

### \* INFORMATION

User profile operation according to door lock/unlock system is as follows.

Item	Personalization operation
Initial value	Guest
Profile linked smart phone key	Linked profile
Profile unlinked smart phone key	Recently activated profile
NFC card key	
Smart key	

## Vehicle personalization with Digital Key 2 Touch

The available personalization function in the vehicle is as follows.

System	Personalization Item		
User Settings menu	Head Up Display (HUD)	Position adjustment of image, Information display selection	
	Lamp	Blink number of one-touch signal lamps	
	Cluster	Information display on the cluster, Voice volume, We come sound	
	Seat	Seat position	
		Smart heating wire ventilation On/Off	
	Door	Automatic door lock/unlock, 2 Press Unlock	
	Smart phone wireless charging	Wireless charging On/Off	
Air conditioning	Setting up temperature unit, Block air inflow/ Automatic ventilation Window defroster On/Off		
Infotainment Settings menu	Navigation	Preferred volume of the navigation system	
		Recent destination	
	User preset	My menu list settings, Radio preset	
Phone connectivity	Bluetooth preferential connection		
	CarPlay/Android Auto/MirrorLink On/Off		
Air conditioning	Operating condition	Latest operation setup of the following functions: Temperature (AUTO), air flow direction, air volume, air conditioner, air intake control, SYNC, Front windshield defroster, OFF	

For more information of personalization, refer to the infotainment system manual.

### CAUTION

If you leave the digital key in the vehicle after locking or unlocking the doors or starting the vehicle with the smart key, the doors can be locked with the central door lock. Have the digital key with you at all times.

## Used Vehicle/Digital Key 2 Touch Maintenance

### Purchasing used vehicle

If any of the digital key devices (smart phone key, card key) are registered in the vehicle, the message 'Digital key(s) active' will appear on the instrument cluster once when the vehicle is turned on after unlocking the vehicle door.

When purchasing a used car, be sure to check the message and delete the smart phone key and card key registered by the previous user. Please let us know the purchase of a used vehicle through an authorized Kia dealer. Check whether the card key that came with the used vehicle operates properly. If the digital key (card key) does not work properly, delete the card key and register the smart phone key, and then re-register the card key.

### Digital Key 2 Touch Maintenance

If you need to have your Digital Key 2 Touch System repaired or replaced, the registered digital key (smart phone)/digital key (card key) can be deleted.

### Limitations of the System

- Digital Key 2 Touch may not work if any of the following occurs:
  - Smart phone battery or the vehicle battery is discharged
  - NFC or Bluetooth is turned off in the smart phone settings
  - A credit card is overlapped in the back of your smart phone, or metal or thick smart phone case is used
  - Using the card key with other cards, or using it in a wallet or card holder

- There is electronic interference by other vehicles, objects, etc.
- There may be a communication error with Digital Key 2 Touch NFC function if the metallic cover or communication device is attached to the smart phone.

If there is a malfunction, remove the cover attached to the smartphone and try again.

- The vehicle may not be controlled by the smart phone if any of the following occurs:
  - Basic and necessary functions of the smart phone are operating (general call, urgent call, audio or NFC payment)
  - Using wireless earphone (general call, urgent call, audio)
  - When Digital Key 2 Touch app function is being limited due to smartphone default settings or app launch priority policy per manufacturer

## Driver Position Memory System (if equipped)

The Driver Position Memory System is provided to store and recall the following memory settings with a simple button operation.



- Driver's seat position
- Outside mirror position (if equipped)
- Head-up display (HUD) (if equipped)

### **⚠ WARNING**

Never attempt to operate the driver position memory system while the vehicle is moving.

This could result in loss of control, and an accident causing death, serious injury, or property damage.

### **\* NOTICE**

- If the battery is disconnected, the memory settings will be erased.
- If the Driver Position Memory System does not operate normally, have the system checked by an authorized Kia dealer.

## Storing memory positions

1. The ignition switch or ENGINE START/STOP button is in the ON position.
2. Adjust the driver's seat position, outside mirror position, and head-up display (HUD) to the desired position.
3. Press one of the memory buttons (1 or 2) for more than 1 second. The system will beep twice.

4. "Settings 1 (or 2) saved" will appear on infotainment screen.

## Recalling memory positions

1. The ignition switch or ENGINE START/STOP button is in the ON position.
2. Press the desired memory button (1 or 2). The system will beep once, and then the driver's seat position, outside mirror position, and head-up display (HUD) will automatically adjust to the stored positions.
3. "Settings 1 (or 2) applied" will appear on the infotainment screen.
  - While recalling the "1" memory position, pressing 1 button temporarily stops the adjustment of the recalled memory position. Pressing the 2 button recalls the "2" memory position.
  - While recalling the "2" memory position, pressing "2" button temporarily stops the adjustment of the recalled memory position. Pressing the "1" button recalls the "1" memory position.
  - While recalling the stored positions, pressing one of the control buttons for the driver's seat and instrument panel illumination will cause the movement of that component to stop and move in the direction that the control button is pressed.

## Driver position memory system reset

If the Driver position memory system does not work properly, initialize the system as follows.

How to initialize:

1. Stop the vehicle and open the driver's door with the ignition switch or ENGINE START/STOP button in the ON position and the vehicle shifted to P (Park).

2. Pull the driver's seat forward as far as possible and have the seatback upright as much as possible using the driver's seat forward/backward adjustment and seatback angle (recline) switches.
3. Press one of the memory buttons (1 or 2) and seat forward movement switch for 2 seconds simultaneously.

Initialization in the process:

1. Initialization begins as the alarm sounds.
2. The seat and seatback will automatically move backwards. The alarm sound will continue while the system is in operation.
3. Initialization will be complete after the seat and seatback move to the center with an alarm sound.

If, however, cases as follows occur, the initialization process will come to a stop and the alarm sound will stop as well.

- When pushing driving position memory system button
- When pushing driver's seat height adjustment switch
- When shifting from P (Park) to other positions
- When driving speed exceeds 3 km/h (2 mph)
- When the driver's door is closed

### Easy access function

The system will move the driver's seat automatically as follows:

With smart key system

- It will move the driver's seat backward when the ENGINE START/STOP button is in the OFF position and the driver's door is opened.
- It will move the driver's seat forward when the vehicle is turned ON or the driver's door is closed with the smart key with you.

You can activate or deactivate the Easy Access Function from the User Settings Mode on the LCD display. For more details, refer to "User settings mode" on page 5-85. If your vehicle is equipped with additional navigation, please refer to the user's manual provided in the infotainment system and the quick reference guide.

### **\* NOTICE**

Upward/downward movement of the seat may not work when passengers get on/off the vehicle in order to prevent foot injuries in certain places.

---

## Liftgate

### ⚠️ WARNING

#### Exhaust fumes

If you drive with the liftgate open, you will draw dangerous exhaust fumes into your vehicle which can cause serious injury or death to vehicle occupants.

If you must drive with the liftgate open, keep the air vents and all windows open so that additional outside air comes into the vehicle.

### ⚠️ WARNING

#### Rear cargo area

Occupants should never ride in the rear cargo area where no restraints are available. To avoid injury in the event of an accident or sudden stops, occupants should always be properly restrained.

### Opening the liftgate

The liftgate is locked or unlocked when all doors are locked or unlocked with the key, smart key or central door lock/unlock switch.

### ⚠️ CAUTION

#### Liftgate lift

Make sure that you close the liftgate before driving your vehicle. Possible damage may occur to the liftgate gas lifters and attached hardware if the liftgate is not closed prior to driving.



- The liftgate is locked or unlocked when all doors are locked or unlocked with the transmitter (or smart key) or central door lock switch.
- If unlocked, the liftgate can be opened by pressing the handle and pulling it up.
- Once the liftgate is opened and then closed, the liftgate locks automatically. (All doors must be locked.)

### \* NOTICE

In cold and wet climates, door lock and door mechanisms may not work properly due to freezing conditions.

### ⚠️ WARNING

The liftgate swings upward. Make sure no objects or people are near the rear of the vehicle when opening the liftgate.

## Closing the liftgate



OSG2PH042042N

- To close the liftgate, lower and push down the liftgate firmly. Make sure that the liftgate is securely latched.

### **⚠ WARNING**

Make sure your hands, feet and other parts of your body are safely out of the way before closing the liftgate.

### **⚠ WARNING**

#### Exhaust fumes

The liftgate lid should be always kept completely closed while the vehicle is in motion. If it is left open or ajar, poisonous exhaust gases may enter the car and serious illness or death may result.

### **⚠ CAUTION**

Make sure nothing is near the liftgate latch and striker while closing the liftgate. It may damage the liftgate's latch.

## Emergency liftgate safety release

Your vehicle is equipped with the emergency liftgate safety release lever located on the bottom of the liftgate. When someone is inadvertently locked in the luggage compartment.



OSG2H041513

The liftgate can be opened by doing as follows:

1. Input the mechanical key into the hole.
2. Push the mechanical key to the right (1).
3. Push up the liftgate.

### **⚠ WARNING**

- You and your passengers must be aware of the location of the Emergency Liftgate Safety Release lever in this vehicle and how to open the liftgate in case you are accidentally locked in the liftgate.
- NEVER allow anyone to occupy the liftgate of the vehicle at any time. If the liftgate is partially or totally latched and the person is unable to get out, serious injury or death could occur due to lack of ventilation, exhaust fumes and rapid heat build-up, or because of exposure to cold weather conditions. The liftgate is also a highly dangerous location in the event of a crash because it is not a protected occupant space but is a part of the vehicle's crush zone.
- Your vehicle should be kept locked and the Smart Key should be kept out of the reach of children. Parents should teach their children about the dangers of playing in liftgates.
- Use the release lever for emergencies only.



**⚠ WARNING**

- No one should be allowed to occupy the cargo area of the vehicle at any time. The cargo area is a very dangerous location in the event of a crash.
- Use the release lever for emergencies only. Use with extreme caution, especially while the vehicle is in motion.

**⚠ CAUTION**

Make sure there are no people or objects around the liftgate before opening or closing the liftgate. Wait until the liftgate is open fully and stopped before loading or unloading cargo from the vehicle.

**⚠ WARNING**

Do not grasp the part supporting the liftgate (gas lifter), as this may cause serious injury.

**Power liftgate (if equipped)****Power liftgate operating conditions**

The power liftgate operates when the gear is in P (Park) with the engine running. However, the power liftgate will operate regardless of the gear position when the engine is off. Also, the liftgate can be opened only when vehicle speed is below 3 km/h (1.8 mph).

For safety, before attempting to open or close the liftgate, make sure the vehicle is in P (Park).

**⚠ WARNING**

- Never leave children or animals unattended in your vehicle. Children may operate the power liftgate. Doing so can result in injury to themselves or others and can damage the vehicle.
- Make sure that there are no people or objects in the path of the power liftgate or smart liftgate prior to use. Serious injury, damage to the vehicle or damage to surrounding objects (for example, walls, ceilings, vehicles, etc.) may result if contact with the liftgate occurs.



- A liftgate covered with snow or equipped with heavy objects (e.g. bike racks, ladders) may not be opened; with the liftgate open, it may be accidentally closed, causing injuries to anyone around the vehicle.

- Do not open the liftgate if the liftgate is covered with snow or equipped with heavy objects.
- Make sure to remove snow and heavy objects before opening the liftgate.

**\* NOTICE**

- Do not close or open the liftgate manually. This may cause damage to the power liftgate. If it is necessary to close or open the liftgate manually when the battery is discharged or disconnected, do not apply excessive force.
- Do not operate the power liftgate more than 10 times continuously when the engine is not running. Use the power liftgate with the engine running when the power liftgate is used repeatedly to prevent battery discharge.
- Do not leave the power liftgate open for a long period of time. This may drain the battery.
- Do not apply excessive force when the power liftgate is operating. Doing so could result in vehicle damage.
- Do not grab or hold on to the liftgate support struts at any time. Damage to the liftgate support struts could result. Deformation of the liftgate support struts may cause vehicle damage and personal injury may occur.



OSG2H041514

- Do not modify or repair any part of the power liftgate by yourself. This

must be done by an authorized Kia dealer.

- Do not operate the power liftgate under the following conditions. The power liftgate may not operate properly.
  - One side of the vehicle is lifted to inspect the vehicle or change a tire
  - Parking on an uneven road such as a slope, etc.
- Close the liftgate completely and lock all doors and liftgate using the central door lock button before using an automatic car wash.
- Do not spray high pressure water directly on the power liftgate outside open/close button. The liftgate may open unintentionally.

**\* INFORMATION**

- If the liftgate is not fully closed and vehicle speed is at or above 3 km/h (1.8 mph), a warning will sound 10 times. Immediately park the vehicle at a safe place, close the liftgate, and check that the liftgate open warning on the instrument cluster is turned off.
- In cold and wet climates, the outside power liftgate open/close button may not work properly due to freezing conditions. If this occurs, remove the ice before using the outside power liftgate open/close button or use the power liftgate open/close button on the smart key or the instrument panel.
- Operating the power liftgate more than 5 times continuously could cause damage to the operating motor. If this occurs, the power liftgate will not operate to prevent the motor from overheating. If any of the power liftgate buttons are pressed to try to open the liftgate, the chime will sound

3 times, but the liftgate will remain closed. Allow the power liftgate system to cool for about 1 minute before operating the system again.

## Operating the power liftgate

### Power liftgate open/close button (Smart key, Instrument panel)



When the liftgate is closed, press the power liftgate open/close button for 1 second. The power liftgate opens with a warning sound.

While the liftgate is opening, press the button to stop liftgate operation.

When the power liftgate is opened, press and hold the power liftgate open/close button to close the liftgate. If you release the button while the liftgate is closing, power liftgate operation will stop with a warning sound for 5 seconds.

Also, if the smart key is not within operation range (approximately 10 m) from the vehicle, power liftgate operation will stop with a warning sound for 5 seconds.

### Power liftgate open/close button (Outside the power liftgate)



When the liftgate is closed, press the power liftgate open/close button to open the liftgate.

If the vehicle is locked, press the power liftgate open/close button with the smart key in your possession.

If the liftgate is unlocked, the liftgate will open or close with a warning sound when the power liftgate open/close button is pressed without carrying the smart key.

### Power liftgate open/close button (Inside the power liftgate)



Press the power liftgate open/close button. The liftgate opens or closes with a warning sound.

### Automatic reverse

During power liftgate operation if the power liftgate senses any obstacle, the liftgate will stop or will fully open. The automatic reverse feature may not oper-

ate properly, or it may operate unexpectedly under the following circumstances:

- The automatic reverse feature may not detect the resistance if the detected resistance is below a certain level, or if the liftgate is almost fully closed near the latched position.
- The automatic reverse feature may operate if a strong impact is applied with no obstructions placed.

### **⚠ WARNING**

Never intentionally place any object or part of your body in the path of the power liftgate to make sure the automatic reverse feature operates. Serious injury, or damage to the vehicle or object may occur.

### **\* INFORMATION**

The power liftgate may stop operating if the automatic reverse feature operates more than two times while attempting to open or close the liftgate. If this occurs, carefully open or close the liftgate manually, and then after 30 seconds try to operate the power liftgate automatically again.

## **Setting the power liftgate**

To use each feature, you must select the opening speed or opening height from the settings menu. Deselect the settings when you do not want to use the feature.

### **Power liftgate opening speed**

To adjust the power liftgate speed, select 'User Settings → Door/liftgate → Power liftgate Opening Speed → Fast/Slow' in the instrument cluster or 'Setup → Vehicle Settings → Door/liftgate →

Power liftgate Opening Speed → Fast/Slow' in the infotainment system. (Default setting is 'Fast')

### **\* INFORMATION**

The infotainment system may change after software updates. For more information, refer to the user's manual provided in the infotainment system and the quick reference guide.

## **Power liftgate opening height**

To adjust the power liftgate opening height, select 'User Settings → Door/liftgate → Power liftgate Opening Height → Full Open/Level 3/Level 2/Level 1/User Height Setting' in the instrument cluster or 'Setup → Vehicle Settings → Door/liftgate → Power liftgate Opening Height → Full Open/Level 3/Level 2/Level 1/User Height Setting' in the infotainment system.

See additional information in supplied Infotainment Manual.

## **User height setting**

1. Position the liftgate manually to the height you prefer.
2. Press the power liftgate open/close button located inside the liftgate for more than 3 seconds.

If 'User Height Setting' is selected for the power liftgate opening height, the power liftgate will automatically open to the height manually set by you.

### **\* INFORMATION**

- The infotainment system may change after software updates. For more information, refer to the user's manual provided in the infotainment system and the quick reference guide.
- If the power liftgate opening height has not been manually set, the power

liftgate will fully open when 'User Height Setting' from the infotainment system is selected.

- If one of the height setting (Full Open/Level 3/Level 2/Level 1) is selected from the settings menu in the infotainment system, and then 'User Height Setting' is selected, the liftgate will open to the height manually set by you.
- The power liftgate opening speed and opening height settings change according to the linked User Profile. If the User Profile is changed, power liftgate opening speed and opening height settings will change accordingly.

2. Press the power liftgate open/close inner button (A) and outer button (B) simultaneously until a chime sounds.
3. Slowly close the liftgate manually.
4. Press the power liftgate open/close outer button. The power liftgate will open with a chime sound.

Wait until the liftgate fully opens to complete resetting. If the liftgate stops before it is fully open, resetting cannot be completed.

**\* INFORMATION**

If the power liftgate does not operate properly after the above procedure, have the system inspected by an authorized Kia dealer.

**Resetting the power liftgate**

In some circumstances resetting the power liftgate operation may need to be performed. Some instances where resetting the power liftgate may be required include:

- When the 12-volt battery is recharged
- When the 12-volt battery is reinstalled after removal or replacement
- When the related fuse is reinstalled after removal or replacement

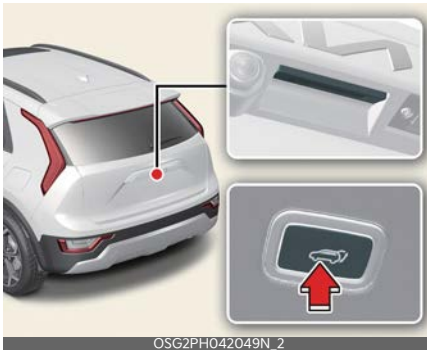

1. With the vehicle off or running, put the gear in P (Park).

**Emergency liftgate safety release**



To unlock and open the liftgate manually from inside the luggage compartment, perform the following procedure:

1. Insert a long, flat object, such as a key into the opening at the bottom of the liftgate.
2. Slide the latch in the direction of the arrow to unlock the liftgate.
3. Push the liftgate to open.

**⚠ WARNING**

- For emergencies, be fully aware of the location of the emergency liftgate safety release latch in the vehicle and how to open the liftgate if you are accidentally locked in the luggage compartment.

- No one, including animals, should be allowed to occupy the luggage compartment of the vehicle at any time. The luggage compartment is a very dangerous location in the event of an accident.
- Use the release latch for emergencies only. Use extreme caution, especially while the vehicle is in motion.

### Smart Liftgate with Auto Open (if equipped)

On a vehicle equipped with a smart key, the liftgate can be opened using the Smart Liftgate with Auto Open system.



### How to use the Smart Liftgate with Auto Open

The liftgate can be opened with no-touch activation satisfying all the conditions below.

- After 15 seconds when all doors are closed and locked
- Positioned in the detecting area for more than 3 seconds.

### \* NOTICE

The Smart Liftgate with Auto Open does not operate when:

- The smart key is detected within 15 seconds after the doors are closed and locked, and is continuously detected.
- The smart key is detected within 15 seconds after the doors are closed and locked, and 1.5 m (60 inches) from the front door handles.
- A door is not locked or closed.
- The smart key is in the vehicle.

### 1. Setting

To activate the Smart Liftgate with Auto Open, go to 'Vehicle → Door → Smart Liftgate' on the LCD display.

## 2. Detect and Alert



If you are positioned in the detecting area (50 ~ 100 cm [20 ~ 40 inches] behind the vehicle) carrying a smart key, the hazard warning lights will blink and chime will sound to alert you the smart key has been detected and the liftgate will open.

### \* NOTICE

Do not approach the detecting area if you do not want the liftgate to open. If you have unintentionally entered the detecting area and the hazard warning lights and chime starts to operate, leave the detecting area with the smart key. The liftgate will stay closed.

## 3. Automatic opening



The hazard warning lights will blink and chime 6 times and then the liftgate will open.

### ⚠ WARNING

- Make sure you close the liftgate before driving your vehicle.
- Make sure there are no people or objects around the liftgate before opening or closing the liftgate.

- Make sure objects in the liftgate do not come out when opening the liftgate on a slope. It may cause serious injury.
- Make sure to deactivate the Smart Liftgate with Auto Open when washing your vehicle. Otherwise, the liftgate may open inadvertently.
- The key should be kept out of reach of children. Children may inadvertently open the Smart Liftgate with Auto Open while playing around the rear area of the vehicle.

### ⚠ CAUTION

#### Liftgate lift

Make certain that you close the liftgate before driving your vehicle. Possible damage may occur to the liftgate gas lifters and attached hardware if the liftgate is not closed prior to driving.

#### How to deactivate the Smart Liftgate with Auto Open function using the smart key



- 1 Door lock
- 2 Door unlock
- 3 Liftgate open
- 4 Panic button
- 5 Remote start

If you press any button of the smart key during the Detect and Alert stage, the Smart Liftgate with Auto Open function will be deactivated.

Make sure to be aware of how to deactivate the Smart Liftgate with Auto Open function for emergency situations.

**\* NOTICE**

- If you press the door unlock button (2), the Smart Liftgate with Auto Open function will be deactivated temporarily. But, if you do not open any door for 30 seconds, the Smart Liftgate with Auto Open function will be activated again.
- If you press the liftgate open button (3) for more than 1 second, the liftgate opens.
- If you press the door lock button (1) or liftgate open button (3) when the Smart Liftgate with Auto Open function is not in the Detect and Alert stage, the Smart Liftgate with Auto Open function will not be deactivated.
- In case you have deactivated the Smart Liftgate with Auto Open function by pressing the smart key button and opened a door, the Smart Liftgate with Auto Open function can be activated again by closing and locking all doors.

- The Smart Liftgate with Auto Open operates with a welcome alert if the smart key is detected within 50 ~ 100 cm (20 ~ 40 inches) from the liftgate.
- The alert stops at once if the smart key is positioned outside the detecting area during the Detect and Alert stage.

**\* NOTICE**

- The Smart Liftgate with Auto Open function will not work if any of the following occurs:
  - The smart key is close to a radio transmitter such as a radio station or an airport which can interfere with normal operation of the transmitter.
  - The smart key is near a mobile two way radio system or a cellular phone.
  - Another vehicle's smart key is being operated close to your vehicle.
- The detecting range may decrease or increase when:
  - One side of the tire is raised to replace a tire or to inspect the vehicle.
  - The vehicle is slantingly parked on a slope or unpaved road, etc.

**Detecting area**





## Windows

The doors of this vehicle are equipped with power windows that can be operated by a switch.

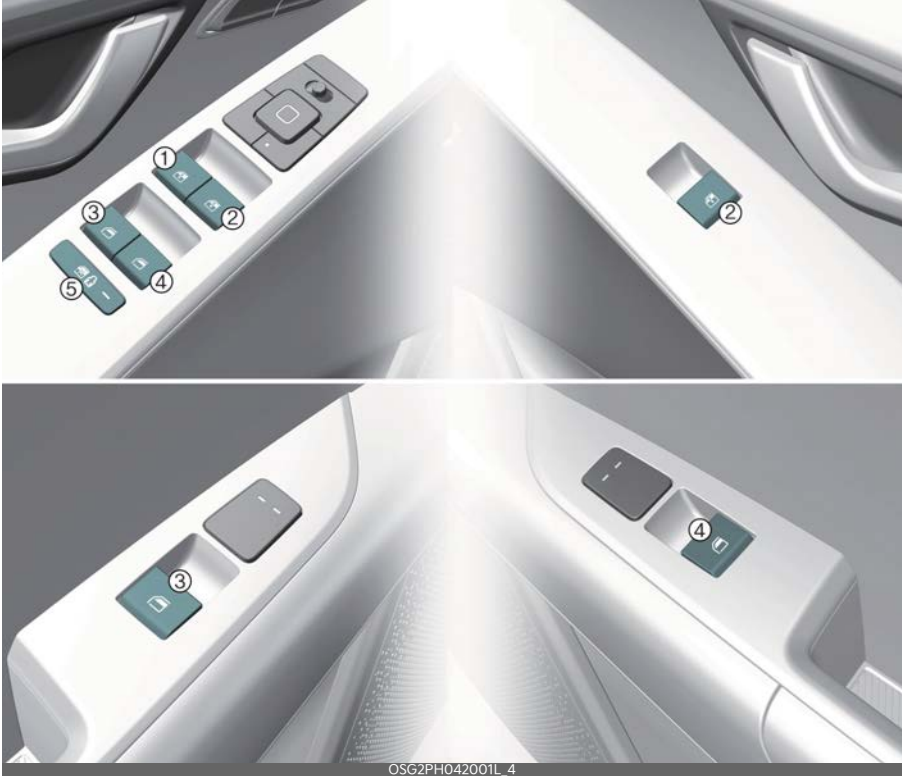

- 1 Driver's door power window switch
- 2 Front passenger's door power window switch
- 3 Rear door (left) power window switch
- 4 Rear door (right) power window switch
- 5 Power window lock switch

**\* NOTICE**

In cold and wet climates, power windows may not work properly due to freezing conditions.

The ignition switch or ENGINE START/STOP button must be in the ON position for power windows to operate.

Each door has a power window switch that controls the door's window. The driver has a power window lock button which can block the operation of rear passenger windows. The power windows can be operated for approximately 3 minutes after ignition switch or ENGINE START/STOP button turned to the ACC or LOCK position. However, if the front doors are opened, the power windows cannot be operated even within the 3 minutes period.

The driver's door has a master power window switch that controls all the windows in the vehicle.

If the window cannot be closed because it is blocked by objects, remove the objects and close the window.

**\* NOTICE**

While driving with the rear windows down or with the sunroof (if equipped) in an open (or partially open position), your vehicle may demonstrate a wind buffeting or pulsation noise. This noise is a normal occurrence and can be reduced or eliminated by taking the following actions. If the noise occurs with one or both of the rear windows down, partially lower both front windows approximately 2.5 cm (1 inches). If you experience the noise with the sunroof open, slightly reduce the size of the sunroof opening.

**⚠ CAUTION**

Do not install any accessories in the vehicle that extend into the open window area. Such objects will impact the proper function of the Automatic reversal "jam protection" feature.

**\* NOTICE**

If you press the one-touch window button for micro adjustment, the glass will go down to a specific location to improve your convenience.

**Window opening and closing**

You can open and close windows using the power window switch.

**Type A**



To open or close a window, press down or pull up the front portion of the corresponding switch to the first detent position (1).

**Type B - Auto up/down window (if equipped)**



Pressing or pulling up the power window switch momentarily to the second detent

position (2) completely lowers or raises the window even when the switch is released. To stop the window at the desired position while the window is in operation, pull up or press down and release the switch.

### To reset the power windows

If the power window does not operate normally, the automatic power window system must be reset as follows:

1. Turn the ignition switch or ENGINE START/STOP button to the ON position.
2. Close the window and continue pulling up the power window switch for at least 1 second after the window is completely closed.

### Automatic reversal (if equipped)



If the upward movement of the window is blocked by an object or part of the body, the window will detect the resistance and will stop upward movement. The window will then lower approximately 30 cm (11.8 inches) to allow the object to be cleared.

If the window detects the resistance while the power window switch is pulled up continuously, the window will stop upward movement then lower approximately 2.5 cm (1 inch).

And if the power window switch is pulled up continuously again within 5 seconds after the window is lowered by the automatic window reversal feature, the automatic window reversal will not operate.

#### \* NOTICE

The automatic reverse feature for the window is only active when the "auto up" feature is used by fully pulling up the switch. The automatic reverse feature will not operate if the window is raised using the halfway position on the power window switch.

#### ⚠ WARNING

Always check for obstructions before raising any window to avoid injuries or vehicle damage. If an object less than 4 mm (0.16 of an inch) in diameter is caught between the window glass and the upper window channel, the automatic reverse window may not detect the resistance and will not stop and reverse direction.

#### ⚠ WARNING

The automatic reverse feature doesn't activate while resetting the power window system. Make sure body parts or other objects are safely out of the way before closing the windows to avoid injuries.

**⚠ CAUTION**

Do not install any accessories in the vehicle that extend into the open window area. Such objects could prevent the automatic reverse feature from functioning.

**Power window lock button**

The driver can disable the power window switches on the rear passengers' doors by pressing the power window lock button to the lock position (pressed).



OSG2H041070

When the power window lock button is pressed:

- The driver's master control can operate all passengers' power windows.
- The front passenger's control can operate the front passenger's power window.
- The rear passengers' control cannot operate the rear passenger's power window.

**⚠ CAUTION**

- To prevent possible damage to the power window system, do not open or close two windows or more at the same time. This will also ensure the longevity of the fuse.
- Never try to operate the main switch on the driver's door and the individual door window switch in opposite directions at the same time. If this is done,

the window will stop and cannot be opened or closed.

**⚠ WARNING****Windows**

- NEVER leave the keys in your vehicle with unsupervised children, when the engine is running.
- NEVER leave any child unattended in the vehicle. Even very young children may inadvertently cause the vehicle to move, entangle themselves in the windows, or otherwise injure themselves or others.
- Always double check to make sure all arms, hands, head and other obstructions are safely out of the way before closing a window.
- Do not allow children play with the power windows. Keep the driver's door power window lock button in the LOCK position (pressed). **SERIOUS INJURY** can result from unintentional window operation by the child.
- Do not extend heads or any limbs outside the window while the vehicle is in motion.

**Remote window opening (if equipped)**

ONQ5031439N

If Auto window down function (safety window function) is equipped, you can still control the corresponding windows movement with engine turned off.

Press the Door Unlock button (1) for more than 3 seconds. The window moves down after the doors are unlocked, as long as you press the door unlock button (1). The window movement stops, when you release the door unlock button (1).

\* Remote window opening requires the automatic power window up/down function equipped for front seat.

**WARNING**

If you stay on the function after operating the Remote window opening function, it is likely to cause a theft. In addition, please use caution there might be a malfunction due to the inflow of water while raining.

**CAUTION**

- The remote window opening function may abruptly stop, when you move away from your vehicle during operation. Stay in close proximity from your vehicle, while monitoring the window movement.
- One of the windows may stop operating, when the window is interrupted by certain force. However, the other windows will keep operating. Thus, you should make sure that all windows are opened.
- Be careful when using the remote window opening function, as the doors will be unlocked.

**Hood**

The hood serves as a cover for the engine compartment.

Open the hood if maintenance work needs to be performed in the engine compartment or if you need to look at the compartment.

**Opening the hood**

1. Pull the release lever to unlatch the hood. The hood should pop open slightly.



2. Go to the front of the vehicle, raise the hood slightly, push the secondary hood release lever (1) to the left and lift the hood (2).



**Hood open warning**

The hood warning message will appear on the LCD display when hood is open.



OSG2PH042128N

The warning chime will operate when the vehicle is being driven at or above 3 km/h (2 mph) with the hood open.

## Closing the hood



OSG2PH042005L

1. Before closing the hood, check the following:
  - All filler caps in the engine compartment must be correctly installed.
  - Gloves, rags or any other combustible material must be removed from the engine compartment.
2. Lower the hood until it is about 30 cm above the closed position and let it drop. Make sure that it locks into place.
3. Check that the hood has engaged properly.
  - If the hood can be raised slightly, it is not properly engaged.
  - Open it again and close it with a little more force.

## ⚠ CAUTION

### Hood obstruction

Before closing the hood, ensure that all obstructions are removed from the hood opening. Closing the hood with an obstruction present in the hood opening

may result in severe personal injury or property damage.

## ⚠ WARNING

### Fire risk

Do not leave gloves, rags or any other combustible material in the motor compartment. Doing so may cause a heat-induced fire.

## ⚠ WARNING

### Unsecured hood

Always double check to be sure that the hood is firmly latched before driving away. If it is not latched, the hood could fly open while the vehicle is being driven, causing a total loss of visibility, which may result in an accident.

## Fuel filler door

The vehicle's fuel filler door must be opened and closed by hand from outside the vehicle.

### Opening the fuel filler door (hybrid vehicle)

1. Turn the engine off.
2. Ensure Driver's door is unlocked.
3. Press the rear center edge of the fuel filler door.



4. Pull the fuel filler door (1) out to fully open.



5. To remove the fuel tank cap (2), turn it counterclockwise. You may hear a hissing noise as the pressure inside the tank equalizes.
6. Place the cap on the fuel filler door.

#### \* NOTICE

The fuel filler door will unlock when all doors are unlocked

To unlock fuel filler door:

- Press the unlock button on your smart key
- Press the Central Door unlock button on armrest trim of driver's door
- Pull the driver's inside door handle outward

The fuel filler door will lock when all doors are locked.

To lock fuel filler door:

- Press the lock button on your smart key
  - Press the Central Door lock button on armrest trim of driver's door
- \* All doors will automatically lock after the vehicle speed exceeds 15 km/h (9.3 mph).

Fuel door is also locked when vehicle speed exceeds 15 km/h (9.3 mph).

#### ⚠ WARNING

Before refueling, be sure to check what type of fuel is used for your vehicle.

If you put diesel fuel into a gasoline-powered vehicle or gasoline into a diesel-powered vehicle, it may affect the fuel system and cause serious damage to the vehicle.

#### \* NOTICE

If the fuel filler door does not open because ice has formed around it, tap lightly or push on the door to break the ice and release the door. Do not pry on the door. If necessary, spray around the door with an approved de-icer fluid (do not use radiator anti-freeze) or move the vehicle to a warm place and allow the ice to melt.

### Opening the fuel filler door (Plug-in hybrid vehicle)

1. Stop the engine. To open the fuel filler door, push the fuel filler door opener button.



2. Wait until the fuel tank is depressurized. The message is displayed when the fuel filler door unlocks after the fuel tank is depressurized.



**A: Unlocking fuel door...**

3. The fuel door is unlocked when the message is displayed.

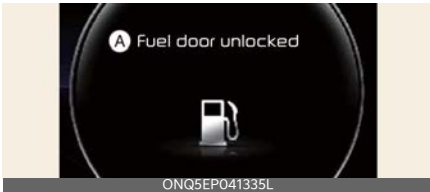

**A: Fuel door unlocked**

4. The fuel door is opened when the message is displayed.

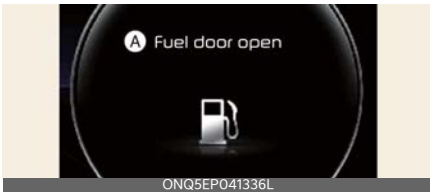

**A: Fuel door open**

5. Pull open the fuel filler door (1). To remove the cap, turn the fuel filler cap (2) counterclockwise. Refuel as needed.



**\* NOTICE**

- It may take up to 20 seconds to unlock fuel filler door.
- If the fuel filler door does not open because ice has formed around it, tap lightly or push on the door to break the ice and release the door.
- Do not pry on the door. If necessary, spray around the door with an approved de-icer fluid (do not use radiator anti-freeze) or move the vehicle to a warm place and allow the ice to melt.

**⚠ WARNING**

Before refueling, be sure to check what type of fuel is used for your vehicle. If you put diesel fuel into a gasoline-powered vehicle or gasoline into a diesel-powered vehicle, it may affect the fuel system and cause serious damage to the vehicle.

**\* NOTICE**

- Add fuel into the fuel tank within 20 minutes after opening the fuel filler door. After 20 minutes, the fuel tank may shut off, causing fuel to overflow. In this case, re-press the fuel filler door opening button.
- Do not leave the fuel filler door opened for an extended period of time. It may discharge the battery.
- Close the fuel filler door after fueling the vehicle. If you start the vehicle



with the fuel filler door opened, "Check fuel door" message illuminates on the LCD display.

- Avoid refueling the vehicle while charging the (high-voltage) hybrid battery. It may cause a fire or an explosion due to static electricity.

### **⚠ WARNING**

#### **For Plug-in Hybrid**

Avoid refueling the vehicle while charging the (high-voltage) hybrid battery. It may cause a fire or an explosion due to static electricity.

#### **Closing the fuel filler door**

1. To install the fuel tank cap, turn it clockwise until it "Clicks".
2. Close the fuel filler door by pressing rear center edge of the fuel filler door.

### **\* NOTICE**

Make the vehicle door to LOCK position when the fuel filler door is completely closed in order to lock the fuel filler door. If the fuel filler door is not completely closed, the fuel filler door will not be locked.

### **⚠ WARNING**

#### **Refueling**

Always remove the fuel cap carefully and slowly. If the cap is venting fuel or if you hear a hissing sound, wait until the condition stops before completely removing the cap.

If pressurized fuel sprays out, it can cover your clothes or skin and subject you to the risk of fire and burns.

### **\* NOTICE**

When refueling on unlevel ground, the fuel gauge may not point to the F position. It is not a malfunction. If you move your vehicle to a level ground, the fuel gauge will move to the full position.

### **\* NOTICE**

Tighten the cap until it clicks one time, otherwise, the engine warning indicator light will appear.

### **⚠ CAUTION**

Keep the door into LOCK position when the vehicle is being washed (i.e. high pressure washer, automatic car washer, etc.)

### **⚠ WARNING**

Always tighten your fuel cap before you leave the fuel station. Failure to securely install your fuel cap can lead to fuel spillage in an accident and increase fire risk.

### **⚠ WARNING**

#### **Fire/explosion risk**

Read and follow all warnings posted at the gas station facility. Failure to follow all warnings will result in severe personal injury, severe burns or death due to fire or explosion.

### **⚠ WARNING**

#### **Static electricity**

- Before touching the fuel nozzle, you should eliminate potentially dangerous static electricity discharge by touching another metal part of the vehicle, a safe distance away from the

fuel filler neck, nozzle, or other gas source.

- Do not get back into a vehicle once you have begun refueling since you can generate static electricity by touching, rubbing or sliding against any item or fabric (polyester, satin, nylon, etc.) capable of producing static electricity. Static electricity discharge can ignite fuel vapors resulting in rapid burning. If you must reenter the vehicle, you should once again eliminate potentially dangerous static electricity discharge by touching a metal part of the vehicle, away from the fuel filler neck, nozzle or other gasoline source.

### **⚠ WARNING**

#### **Portable fuel container**

When using an approved portable fuel container, be sure to place the container on the ground prior to refueling. Static electricity discharge from the container can ignite fuel vapors causing a fire. Once refueling has begun, contact with the vehicle should be maintained until the filling is complete. Use only approved portable plastic fuel containers designed to carry and store gasoline.

### **⚠ WARNING**

#### **Cell phone fires**

Do not use cellular phones while refueling. Electric current and/or electronic interference from cellular phones can potentially ignite fuel vapors causing a fire.

### **⚠ WARNING**

#### **Refueling & Vehicle fires**

When refueling, always shut the engine off. Sparks produced by electrical components related to the engine can ignite fuel vapors causing a fire. Once refueling is complete, check to make sure the filler cap and filler door are securely closed, before starting the engine.

### **⚠ WARNING**

#### **Smoking**

DO NOT use matches or a lighter and DO NOT SMOKE or leave a lit cigarette in your vehicle while at a gas station especially during refueling. Automotive fuel is highly flammable and can result in fire when ignited.

Make sure to refuel your vehicle according to "Fuel requirements" on page 2-2. If the fuel filler cap requires replacement, use only a genuine Kia cap or the equivalent specified for your vehicle. An incorrect fuel filler cap can result in a serious malfunction of the fuel system or emission control system.

### **⚠ CAUTION**

#### **Exterior paint**

Do not spill fuel on the exterior surfaces of the vehicle. Any type of fuel spilled on painted surfaces may damage the paint.

### **⚠ WARNING**

- Do not allow anyone that has not discharged static electricity from their body to come close to an open fuel tank.
- Do not inhale vaporized fuel.

**⚠ WARNING****Risk of injury from fuel**

Fuels are poisonous and harmful to your health.

- Fuel contains substances that are harmful if inhaled.
- Do not swallow fuel or let it come into contact with skin, eyes or clothing.
- Do not inhale fuel vapors.
- Keep children away from fuel.

If you or other people come into contact with fuel, observe the following:

- Immediately rinse fuel off your skin with soap and water.
- If fuel comes into contact with your eyes, immediately rinse them thoroughly with clean water. Seek medical attention immediately.
- If you swallow fuel, seek medical attention immediately. Do not induce vomiting.
- Change immediately out of clothing that has come into contact with fuel.

**\* NOTICE****Damage caused by the wrong fuel**

Fuel that does not conform to the required quality can lead to increased wear as well as damage to the engine and exhaust system. Only use the fuel recommended.

**\* NOTICE****Damage caused by the wrong fuel**

Vehicles with a gasoline engine:

Even small amounts of the wrong fuel could result in damage to the fuel system, the engine and the emission control system.

**\* NOTICE**

Do not use diesel to refuel vehicles with a gasoline engine.

**\* NOTICE**

Do not press the ENGINE START/STOP button if you accidentally refuel with the wrong fuel. Otherwise, fuel can enter the fuel system.

Even small amounts of the wrong fuel could result in damage to the fuel system and the engine. Have the system serviced by an authorized Kia dealer.

**\* NOTICE****Do not overfill the fuel tank**

Do not overfill the fuel tank; otherwise fuel may spill, causing harm to the environment and damaging the vehicle.

**⚠ WARNING**

In case of using EV drive mode for a certain time without running engine, EMM (Engine Maintenance Mode) will automatically activate by the system to protect the fuel system and the engine.

Therefore, even though if it is possible to use EV drive mode with enough battery power, the engine may run by the system to protect fuel system and the engine. If you leave the fuel without refueling or using for over 6 months, the remained fuel in the fuel system may be deteriorated. From this, corrosion or blocking problem may occur.

It is recommended using minimum 40% of remained fuel at least every 6 months by selecting Hybrid (CS) mode and refuel the vehicle with new fuel.

## Sunroof (if equipped)

If your vehicle is equipped with a sunroof, you can slide or tilt your sunroof with the sunroof switch located on the overhead console.



OSG2H041071

The sunroof can only be operated when the ignition switch or the ENGINE START/STOP button is in the ON or START position.

The sunroof can be operated for approximately 3 minutes after the ignition switch or ENGINE START/STOP button is in the ACC or LOCK/OFF position.

However, if the front door is open, the sunroof cannot be operated even within the 3 minutes period.

### **⚠ WARNING**

- Adjust the sunroof or sunshade when your vehicle stops. This could result in loss of control and an accident that may cause injury, or property damage.
- Do not leave the engine running and the key in your vehicle with unsupervised children. Unattended children could operate the sunroof, which could result in serious injury.
- Do not sit on the top of the vehicle. It may cause injury or vehicle damage.

### **\* NOTICE**

Do not operate the sunroof when roof bars are installed on the vehicle or when there is luggage on the roof.

## Sunshade



OSG2H041064

Use the sunshade to block direct sunlight coming through the sunroof glass. Open or close the sunshade by hand.

### **\* INFORMATION**

The sunshade opens automatically when the sunroof glass is opened, but the sunshade does not close automatically when the sunroof glass is closed. Also, only the sunshade cannot be closed when the sunroof glass is opened.

### **\* NOTICE**

Do not pull the sunshade up or down, or apply excessive force as such action may damage the sunshade or cause it to malfunction.

## Tilt open/close



OSG2H041527\_3

- 1 Tilt open
- 2 Tilt close

- Push the sunroof switch upward, the sunroof glass tilts open.
- Push the sunroof switch forward when the sunroof glass is tilt opened, the sunroof glass closes.

The sunroof glass tilts open or closes while the switch is pushed.

**\* INFORMATION**

The sunroof glass cannot slide open and tilt open at the same time. You cannot tilt the sunroof glass open while the sunroof glass is slide open. Also, you cannot slide the sunroof glass open while the sunroof is tilt open. Slide open or tilt open the sunroof glass when the sunroof glass is completely closed.

**Slide open/close**



- Push the sunroof switch rearward, the sunshade and sunroof glass slide open.  
Push the sunroof switch forward, only the sunroof glass closes.
- Push the sunroof switch forward or rearward to the first detent position, the sunroof glass moves until the switch is released.
- Push the sunroof switch forward or rearward to the second detent position, the sunroof glass operates automatically (auto slide feature). To stop the sunroof movement at any point, push the sunroof switch in any direction.

- The sunroof glass stops halfway (first detent position) before it is fully opened. To fully open the sunroof glass, push the sunroof switch rearward once more. At this time, the sunroof glass opens only while the switch is pushed.

**\* INFORMATION**

To reduce wind noise while driving, we recommend that you drive at the recommended position (first detent position) before the maximum slide open position.

**Automatic reversal**



If the sunroof glass senses any obstacle while it is closing automatically, it will reverse direction then stop at a certain position.

The auto reverse function may not work if an object thin or soft is caught between the sliding sunroof glass and sunroof sash.

**⚠ WARNING**

- Make sure heads, hands, arms or any other body parts or objects are out of the way before operating the sunroof. Body parts or objects may get caught causing injuries or vehicle damage.
- Never deliberately use your body parts to test the automatic reversal function. The sunroof glass may reverse direction, but there is a risk of injury.

## \* NOTICE

- Do not continue to push the sunroof switch after the sunroof is fully opened, closed, or tilted. Damage to the sunroof motor could occur.
- Continuous operations such as slide open/close, tilt open/close, etc. may cause the motor or sunroof system to malfunction.
- Regularly remove any accumulated dust on the sunroof rail.
- Dust accumulated between the sunroof and roof panel can make noise. Open the sunroof and remove dust regularly using a clean cloth.
- Do not try to open the sunroof when the temperature is below freezing or when the sunroof is covered with snow or ice. The sunroof may not work properly and may break if opened by force.
- Do not open or drive with the sunroof glass open immediately after rain or washing the vehicle. Water may wet the interior of the vehicle.
- Do not extend any luggage outside the sunroof while driving. Vehicle damage may occur if the vehicle suddenly stops.

## ⚠ WARNING

Do not extend your head, arms, body parts or objects outside the sunroof while driving. Injuries may occur if the vehicle suddenly stops.

## Resetting the sunroof



In some circumstances resetting the sunroof operation may need to be performed. Some instances where resetting the sunroof may be required include:

- When the 12-volt battery is either disconnected or discharged
- When the sunroof fuse is replaced
- If the sunroof one-touch AUTO OPEN/CLOSE operation is not functioning properly

Sunroof resetting procedure:

1. It is recommended to perform the reset procedure with the vehicle engine running. Start the vehicle in P (Park).
2. Make sure the sunroof glass is in the fully closed position. If the sunroof glass is open, push the switch forward until the sunroof glass is fully closed.
3. Release the switch when the sunroof glass is fully closed.
4. Push the switch forward until the sunroof glass moves slightly. Then release the switch.
5. Once again push and hold the sunroof switch forward until the sunroof glass slides open and close. Do not release the switch until the operation is completed.

If you release the switch during operation, start the procedure again from step 2.

### \* INFORMATION

If the sunroof does not reset when the vehicle battery is disconnected or discharged, or the sunroof fuse is blown, the sunroof may not operate normally.

### Sunroof open warning



If the driver turns off the engine when the sunroof is not fully closed, the warning chime will sound for several seconds and the sunroof open warning will appear on the cluster LCD display.

Close the sunroof securely when leaving your vehicle.

### ▲ CAUTION

Make sure the sunroof is closed fully when leaving your vehicle. If the sunroof is left open, rain or snow may wet the interior of the vehicle.

Also, leaving the sunroof open when the vehicle is unattended may invite theft.

## Steering wheel

The steering wheel of this vehicle is equipped with the Motor Driven Power Steering (MDPS) system.

### Motor Driven Power Steering (MDPS)

Power steering uses the motor to assist you in steering the vehicle.

If the engine is off or if the power steering system becomes inoperative, the vehicle may still be steered, but it will require increased steering effort.

The EPS is controlled by the power steering control unit which senses the steering wheel torque and vehicle speed to command the motor.

The steering effort becomes heavier as the vehicle's speed increases and becomes lighter as the vehicle's speed decreases for better control of the steering wheel.

Should you notice any change in the effort required to steer during normal vehicle operation, have the system checked by an authorized Kia dealer.

### \* NOTICE

The following symptoms may occur during normal vehicle operation:

- When the ENGINE START/STOP button is the ON position, the steering wheel enters normal operation mode after diagnosing the Motor Driven Power Steering system (for about 3 seconds).
- A click noise may be heard from the EPS relay after turning the ENGINE START/STOP button is turned to the ON or OFF position.
- If the steering wheel is operated when the vehicle is not in motion or driven

at a low speed, you may hear some noise.

- If the Motor Driven Power Steering system does not operate normally, the warning light will appear or blink on the instrument cluster. If the power assistance of steering fails, you will need to use more force to steer.
- Operating the steering wheel at lower temperatures may require more force and accompany noise. However, when the temperature increases, it returns to normal.
- Take your vehicle to an authorized Kia dealer and have the vehicle checked as soon as possible.
- When the charging system warning light comes on due to the low voltage (when the alternator or battery does not operate normally or malfunctions), the steering wheel may require increased steering effort.
- When jump starting the vehicle after battery discharge, the steering wheel may not function properly. It is a temporary situation due to low battery voltage, and upon stable battery charging, the steering wheel will function normally again. Please move the steering wheel around to make sure the steering wheel is functioning properly before driving the vehicle.
- The steering effort can suddenly increase, if the operation of the EPS system is stopped to prevent serious accidents when EPS control unit detects malfunction of the EPS system by self-diagnosis.

### **⚠ CAUTION**

When you continuously operate the steering wheel, the overcurrent protection device is activated and it requires

more force to operate the steering wheel. However, this doesn't indicate a malfunction, and it works for your safety and will return to normal after some time.

### **⚠ CAUTION**

If the Motor Driven Power Steering (MDPS) system does not work or an error occurs, the warning light on the instrument panel may be turned on or blink and it may require more force to operate the steering wheel. In this case, please hold the steering wheel more tightly than usual and operate with greater force. And then immediately pull your vehicle over to a safe place and have your vehicle inspected by an authorized Kia dealer.

### **Tilt & telescopic steering wheel**

A tilt and telescopic steering wheel allows you to adjust the steering wheel before you drive. You can also raise it to give your legs more room when you exit and enter the vehicle.

The steering wheel should be positioned so that it is comfortable for you to drive, while permitting you to see the instrument panel warning lights and gauges.

### **⚠ WARNING**

#### **Steering wheel adjustment**

Never adjust the angle and height of the steering wheel while driving. You may lose steering control.



## Adjusting steering wheel angle and height

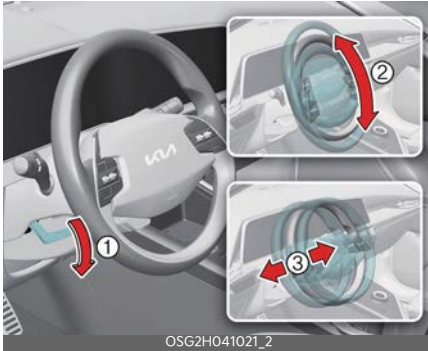

1. To change the steering wheel angle, pull down the lock release lever (1).
2. Adjust the steering wheel to the desired angle (2) and distance forward/back (3).

Move the steering wheel, so it points toward your chest, not toward your face. Make sure you can see the instrument panel warning lights and gauges. After adjusting, pull up the lock.

3. Pull up the lock-release lever to lock the steering wheel in place.

Push the steering wheel both up and down to be certain it is locked in position.

4. Be sure to adjust the steering wheel to the desired position before driving.

### \* NOTICE

After adjustment, sometimes the lock-release lever may not lock the steering wheel.

It is not a malfunction. This occurs when two gears engage. In this case, adjust the steering wheel again and then lock the steering wheel.

### ⚠ CAUTION

While adjusting the steering wheel angle and height, please do not push or pull it hard since the fixture can be damaged.

## Heated steering wheel (if equipped)

When the ignition switch or ENGINE START/STOP button is in the ON position, pressing the heated steering wheel button warms the steering wheel. The indicator on the button will appear.



To turn the heated steering wheel off, press the button once again. The indicator on the button will turn off.

- The heated steering wheel defaults to the OFF position whenever the ignition switch or ENGINE START/STOP button is in the ON position.

### \* NOTICE

The heated steering wheel will turn off automatically approximately 30 minutes after the heated steering wheel is turned on.

### ⚠ CAUTION

- Do not install any type of grip cover for the steering wheel, it may impair the function of the heated steering wheel system.
- When cleaning the heated steering wheel, do not use an organic solvent such as paint thinner, benzene, alco-

hol and gasoline. Doing so may damage the surface of the steering wheel.

- If the surface of the steering wheel is damaged by a sharp object, damage to the heated steering wheel components could occur.

**⚠ WARNING**

If the steering wheel becomes too warm, turn the system off. The heated steering wheel may cause burns even at low temperatures, especially if used for long periods of time.

**Horn**

To sound the horn, press the area indicated by the horn symbol on your steering wheel (see illustration).



The horn will operate only when this area is pressed. Check the horn regularly to be sure it operates properly.

**⚠ CAUTION**

Do not strike the horn severely to operate it, or hit it with your fist. Do not press on the horn with a sharp-pointed object.

**Mirrors**

This vehicle is equipped with inside and outside rear view mirrors to provide views of objects behind the vehicle.

**Inside rear view mirror**

Adjust the rear view mirror so that the center view through the rear window is seen. Make this adjustment before you start driving.

Do not place objects in the rear seat or cargo area which would interfere with your vision out the rear window.

**⚠ WARNING**

**Mirror adjustment**

Do not adjust the rear view mirror while the vehicle is moving. This could result in loss of control.

**\* NOTICE**

Do not modify the inside mirror in any manner, including installing a wide mirror. Doing so could result in injury during an accident or deployment of the air bag.

**⚠ CAUTION**

**Cleaning mirror**

When cleaning the mirror, use a paper towel or similar material dampened with glass cleaner. Do not spray glass cleaner directly on the mirror. It may cause the liquid cleaner to enter the mirror housing.

### Day/night rear view mirror (if equipped)

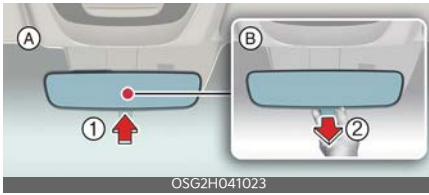

(A): Day, (B): Night

Make this adjustment before you start driving and while the day/night lever is in the day position (1).

Pull the day/night lever toward you (2) to reduce the glare from the headlamps of the vehicles behind you during night driving.

Remember that you lose some rear view clarity in the night position.

### For Kia Connect button function: (if equipped)



- 1 Kia Connect button
- 2 Roadside assist button

### Electric Chromic Mirror (ECM) (if equipped)

The electric rear view mirror automatically controls the glare from the headlamps of the vehicles behind you in nighttime or low light driving conditions.

The sensor mounted in the mirror senses the light level around the vehicle, and automatically controls the headlamp glare from the vehicles behind you.

When the engine is running, the glare is automatically controlled by the sensor mounted in the rear view mirror.

### Electric chromic mirror (ECM) with HomeLink® system (if equipped)

Electric Chromic Mirror (ECM) is that controls the glare from the headlamps of the vehicles behind you in nighttime or low light driving conditions.

The sensor mounted in the mirror senses the light level around the vehicle, and automatically controls the headlamp glare from the vehicles behind you.

When the engine is running, the glare is automatically controlled by the sensor mounted in the rear view mirror.



- 1 HomeLink Channel 1
  - 2 HomeLink Channel 2
  - 3 HomeLink Channel 3
  - 4 Garage Door Opener Status Indicator: Closing or Closed
  - 5 HomeLink Operation Indicator
  - 6 Garage Door Opener Status Indicator: Opening or Opened
  - 7 HomeLink User Interface Indicator
- Your vehicle may be equipped with a Gentex Automatic-Dimming Mirror with an Integrated HomeLink® Wireless Control System.

During nighttime driving, this feature will automatically detect and reduce rear view mirror glare. The HomeLink® Universal Transceiver allows you to activate

your garage door(s), electric gate, home lighting, etc.

### Automatic-Dimming Night Vision Safety™ (NVS®) Mirror (if equipped)

The NVS® Mirror automatically reduces glare by monitoring light levels in the front and the rear of the vehicle. Any objects that obstructs the light sensor will degrade the automatic dimming control feature.

**For more information regarding NVS® mirrors and other applications, please refer to the Gentex website:**

**[www.gentex.com](http://www.gentex.com)**

Your mirror will automatically dim upon detecting glare from the vehicles traveling behind you.

The mirror defaults to the ON position each time the vehicle is started.

### Integrated HomeLink® Wireless Control System

The HomeLink® Wireless Control System provides a convenient way to replace up to three handheld radio-frequency (RF) transmitters used to activate compatible devices such as gate operators, garage door openers, entry door locks, security systems, and home lighting.

#### \* NOTICE

Considering the Home Security when the vehicle is parked outside the garage, the HomeLink will ONLY work when the ignition switch is in ACC position or ON position.

#### ▲ CAUTION

Before programming HomeLink to a garage door opener or gate operator, make sure that people and objects are out of the way of the device to prevent potential harm or damage. When programming a garage door opener, it is advised to park outside of the garage.

Do not use HomeLink with any garage door opener that lacks safety stop and reverse features as required by U.S. federal safety standards (this includes any garage door opener model manufactured before April 1, 1982). A garage door that cannot detect an object signaling the door to stop and reverse - does not meet current U.S. federal safety standards. For more information, contact HomeLink at **[www.homelink.com](http://www.homelink.com)**, or call HomeLink customer support at **1-800-355-3515**.

It is also recommended that a new battery be replaced in the hand-held transmitter of the device being trained to HomeLink for quicker training and accurate transmission of the radio frequency.

### 1. Programming HomeLink®

The following steps show how to program HomeLink. If you have any questions or are having difficulty programming your HomeLink buttons, refer to the HomeLink website or call the HomeLink customer support toll-free number. Do this, before going back to the dealer who sold you the car.

- Visit the HomeLink website at: [www.homelink.com](http://www.homelink.com). Then at the top of the page, choose your vehicle make. Then watch the You Tube video, and/or access additional website information.

- If you choose to access the website via your cell phone, scan the QR code.



- Or, call HomeLink customer support at **1-800-355-3515**  
(Please have the vehicle make/model AND the opener device make/model readily available.)

### 1) Programming Preparation

1. When programming a garage door opener, it is advised to park the vehicle outside of the garage.
2. It is recommended that a new battery be placed in the hand-held transmitter of the device being programmed to HomeLink for quicker training and accurate transmission of the radio-frequency signal.
3. Place the ignition switch or ENGINE START/STOP button to the ACC (Accessory) position for programming of HomeLink.



### 2) Programming a New HomeLink® Button

1. Press and release the HomeLink button (1), (2) or (3), you would like to program. The HomeLink indicator light (7) will flash orange slowly (if not, perform the steps of "Erasing HomeLink Buttons" section, and start over).



2. Position the garage door opener remote 2 - 8 cm (1 - 3 inches) away from the HomeLink buttons.



3. While the HomeLink indicator light (7) is flashing orange, press and hold the hand-held remote button. Continue pressing the hand-held remote button until the HomeLink indicator light (7) light changes from orange to green. You may now release the hand-held remote button.
4. Wait until your garage door comes to a complete stop, regardless of position, before proceeding to the next steps.
5. Press and release the HomeLink button you are programming and observe the indicator light.
  - If the indicator light remains solid green, your device should operate when the HomeLink button is pressed. At this point, if your device operates, programming is complete.

- If the indicator light rapidly flashes green, firmly press, hold for two seconds and release the HomeLink button up to three times in a row slowly to complete the programming process. Do not press the HomeLink button rapidly. At this point if your device operates, programming is complete. If the device does not operate, continue with step 6.
6. At the garage door opener motor, (security gate motor, etc.) locate the "Learn", "Smart", "Set" or "Program" button. This can usually be found where the hanging antenna wire is attached to the motor-head unit (see the device's manual to identify this button). The name and color of the button may vary by manufacturer.

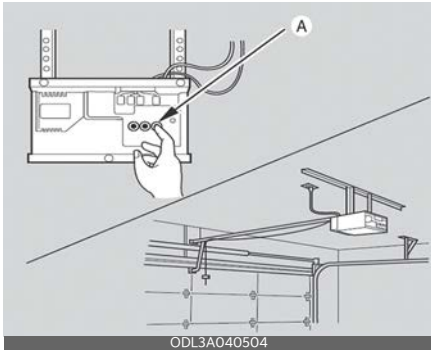

\* A ladder and/or second person may simplify the following steps.

7. Firmly press and release the "Learn", "Smart", "Set" or "Program" button. You now have up to 30 seconds in which to complete the next step.
8. Return to the vehicle and firmly press, hold for two seconds and release, the HomeLink button up to three times in a row slowly. Do not press the HomeLink button rapidly. As soon as you

see the garage door start to move, stop pressing any buttons until a few seconds after the garage door has come to a complete stop, regardless of position. At this point programming is complete and your device should operate when the HomeLink button is pressed and released.

### 3) Two-Way Communication Programming (For select garage door openers)

If your garage door opener has the 'myQ' logo on its side, your opener has Two-Way Communication capability. HomeLink has the capability to establish Two-Way Communication with your garage door opener. HomeLink can receive and display "closing" or "opening" status messages from compatible garage door openers. At any time, HomeLink can also recall and display the last recorded status communicated by the garage door opener to indicate your garage door being "closed" or "opened".

To check if your garage door opener is compatible with this feature, refer to [www.homelink.com/compatible/Two-way-Communication](http://www.homelink.com/compatible/Two-way-Communication). If your garage door opener has this functionality, AND the Two-Way Communication indicators (4), (6) in the mirror appear while the garage door is opening/closing, then no further steps are needed. Two-Way Communication Programming is already complete. However, if your garage door opener has this functionality, AND the Two-Way Communication indicators (4), (6) in the mirror DO NOT appear while the garage door is opening/closing, use the following instructions to enable this functionality.

1. In your vehicle, press and hold the programmed HomeLink button for 2 seconds, then release. Confirm that the garage door is moving. AFTER it stops, you will have one minute to complete the following steps:
  - \* A ladder and/or second person may simplify the following steps.
2. On your garage door opener in your garage, locate the "Learn" button (usually near where the hanging antenna wire is attached to the garage door opener). If there is difficulty locating this button, refer to the device's owner's manual.
3. Press and release the "Learn" button.
4. A light on your garage door opener may flash, and your Two-Way Communication indicators (4), (6) in your vehicle may flash, confirming completion of the process.
5. Return to the vehicle and firmly press and release the programmed HomeLink button to activate your garage door. The Two-Way Communication indicators (4), (6) flash in orange when the door is moving. Do not make any additional button presses until AFTER the garage door has come to a complete stop.
6. Your Two-Way Communication programming is now complete.

#### \* NOTICE

If your garage door opener has Two-Way Communication functionality, it is possible for HomeLink to stop functioning the garage door shortly after initial programming, if the Two-Way Communication Programming wasn't properly completed. This usually happens after the first 10 times a programmed HomeLink button is pressed. If you experience this, completing the "Programming a New HomeLink Button" and "Two-Way Communication Programming" will restore door operation.

#### 4) Canadian Programming

Canadian radio-frequency laws require transmitter remote signals to "time-out" (or quit) after a couple seconds of transmission, which may not be long enough for HomeLink to pick up the signal during programming.

If you live in Canada or you are having difficulties programming a gate operator or garage door opener by using the programming procedures, replace "Programming a New HomeLink Button" step 3 with the following:

While the HomeLink indicator light (7) is flashing orange, press and release ("cycle") your device's hand-held remote every two seconds until the HomeLink indicator light (7) changes from orange to green. You may now release the hand-held remote button. Then proceed with "Programming a New HomeLink Button" step 4.

## 2. Operating HomeLink®

### 1) Operating HomeLink®

1. Press and release the desired programmed HomeLink button (1, 2 or 3).



#### \* NOTICE

The HomeLink indicator (7) should light green, solid or flashing, and your programmed device should operate. If your device does not operate, the HomeLink programming was not successful, and you'll need to reprogram the button.

### 2) Two-Way Communication Display Behavior

1. Press and release one of the programmed HomeLink buttons (1, 2 or 3)



2. The indicator (4) and (6) operates as below, if your garage door opener has Two-Way Communication functionality.



- If the indicator (4) flashes in Orange, it indicates that the garage door is "Closing".
- The indicator (4) turns solid green once the garage door has closed.
- If the indicator (6) flashes in Orange, it indicates that the garage door is "Opening".
- The indicator (6) turns solid green once the garage door has fully opened.
- If the indicator (4) or (6) does not turn to green, it indicates that the last status of garage door was not received properly. The HomeLink mirror tries to receive the last known status of the garage door for a few seconds.

### 3) Recalling Garage Door Status

HomeLink mirror with Two-Way Communication provides a way to view the last stored message from the garage door opener. In order to recall the last known status of the last activated device, press the buttons "1 and 2" OR "2 and 3" simultaneously.

- If the indicator (4) appears solid Green, it indicates that the last activated device was properly "closed".
- If the indicator (6) appears solid Green, it indicates that the last activated device was properly "open".



### 3. Erasing HomeLink® Buttons

#### 1) Erasing and Reprogramming a Single HomeLink® Button:

1. Press and hold the desired HomeLink button you want to re-program. DO NOT release the button.
2. The HomeLink indicator light (7) will begin appear solid green. Release the button as soon as the HomeLink indicator light (7) begins to flash orange, usually about 20 seconds.
3. Proceed with the steps in the "Programming a New HomeLink Button" section.

**\* NOTICE**

If you do not complete the re-programming of a new device to the button, it will revert to the previously stored programming.

#### 2) The following instructions will erase ALL HomeLink® programming from ALL buttons:



1. Press and hold the buttons (1) and (3) simultaneously
2. The HomeLink indicator light (7) will appear solid Orange for about 10 seconds
3. Release the buttons once the HomeLink indicator light (7) changes to Green and flashes rapidly

4. Now all three HomeLink buttons (1), (2) and (3) are cleared of any programming

#### Information

HomeLink and the HomeLink House logo are registered trademarks of Gen-tex Corporation.

The myQ logo is a registered trademark of The Chamberlain Group, Inc

#### FCC (USA) and ISED (Canada)

This device complies with FCC rules part 15 and Innovation, Science, and Economic Development Canada RSS-210. Operation is subject to the following two conditions: (1) This device may not cause harmful interference, and (2) This device must accept any interference that may be received including interference that may cause undesired operation. **WARNING:** The transmitter has been tested and complies with FCC and ISED rules. Changes or modifications not expressly approved by the party responsible for compliance could void the user's authority to operate the device.

This equipment complies with FCC and ISED radiation exposure limits set forth for an uncontrolled environment. End Users must follow the specific operating instructions for satisfying RF exposure compliance. This transmitter must be at least 20 cm from the user and must not be co-located or operating in conjunction with any other antenna or transmitter.

**FCC (États-Unis) et ISED (Canada)**

Cet appareil est conforme aux règlements de la FCC, section 15, et au CNR-210 d'Innovation, Sciences et Développement économique Canada. Le fonctionnement est assujéti aux deux conditions suivantes: (1) cet appareil ne doit pas causer d'interférences nuisibles et (2) cet appareil doit accepter toute interférence reçue, y compris celle qui pourrait entraîner un dysfonctionnement. MISE EN GARDE: L'émetteur a subi des tests et est conforme aux règlements de la FCC et d'ISDE. Les changements ou modifications non approuvés explicitement par la partie responsable de la conformité pourraient rendre caduque l'autorisation de l'utilisateur de se servir du dispositif.

Cet appareil est conforme aux limites d'exposition aux radiations de la FCC et d'ISDE établies pour un environnement non contrôlé. Les utilisateurs finaux doivent respecter les instructions d'utilisation spécifiques pour satisfaire aux exigences de conformité aux expositions de RF. L'émetteur doit se trouver à 20 cm au minimum de l'utilisateur et ne doit pas être situé au même endroit que tout autre émetteur ou antenne ni fonctionner avec un autre émetteur ou antenne.

# HomeLink 5 Programing Flow Chart

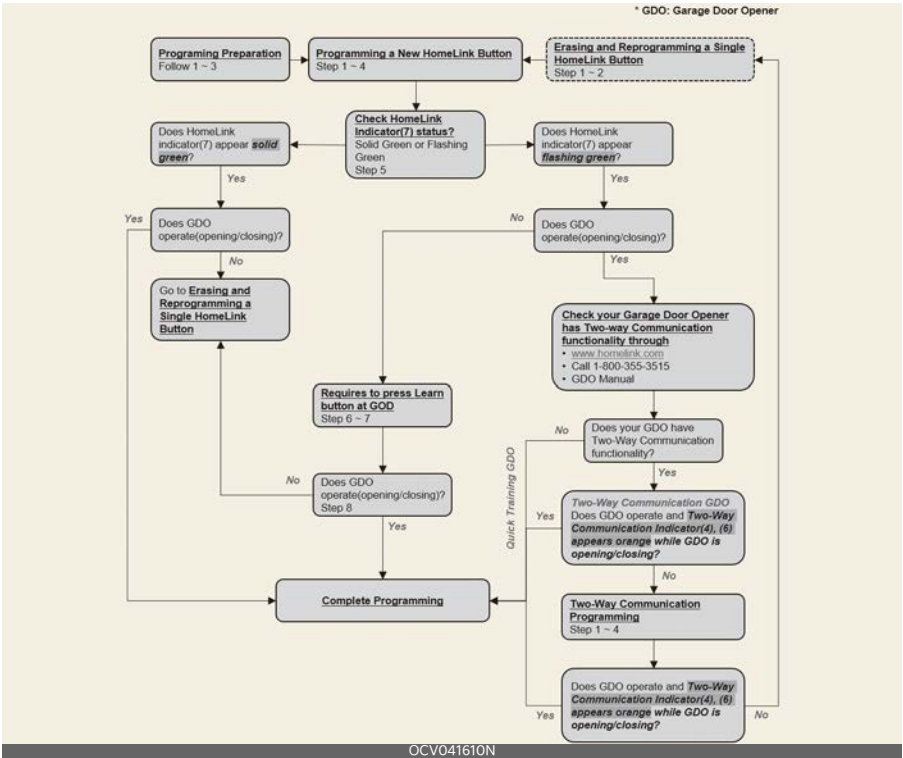

## Outside rear view mirror

Your vehicle is equipped with both left-hand and right-hand outside rear view mirrors.

Be sure to adjust the mirror angles before driving.

The mirrors can be adjusted remotely with the control levers or remote switch, depending on the type of mirror control installed. The mirror heads can be folded back to prevent damage during an automatic car wash or when passing through a narrow street.

### \* NOTICE

#### Rear view mirrors

- The outside rear view mirror is convex. Objects seen in the mirror are closer than they appear.
- Use your interior rear view mirror or direct observation to determine the actual distance of following vehicles when changing lanes.

### ⚠ CAUTION

Do not scrape ice off the mirror face; this may damage the surface of the glass. If ice should restrict the movement of the mirror, do not force the mirror for adjustment. To remove ice, use a deicer spray, or a sponge or soft cloth with warm water.

### ⚠ CAUTION

If the mirror is jammed with ice, do not adjust the mirror by force. Use an approved spray de-icer (not radiator antifreeze) to release the frozen mechanism or move the vehicle to a warm place and allow the ice to melt.

### ⚠ WARNING

Do not adjust or fold the outside rear view mirrors while the vehicle is moving. This could result in loss of control, and an accident which could cause DEATH, SERIOUS INJURY, or property damage.

## Adjusting the outside rear view mirrors

The electric remote control mirror switch allows you to adjust the position of the left and right outside rear view mirrors.



Adjusting the rear view mirrors:

1. Move the R or L switch (1) to select the right side mirror or the left side mirror.
2. Press a corresponding point on the mirror adjustment control (2) to position the selected mirror up, down, left or right.

### ⚠ CAUTION

- The mirrors stop moving when they reach the maximum adjusting angles, but the motor continues to operate while the switch is pressed. Do not press the switch longer than necessary, the motor may be damaged.
- Do not attempt to adjust the outside rear view mirror by hand. Doing so may damage the parts.

## Folding the outside rear view mirror

### Manual type (if equipped)

To fold the outside rear view mirror, grasp the housing of the mirror and then fold it toward the rear of the vehicle.



### Electric type

The outside rear view mirror can be folded or unfolded by pressing the switch as below.



- To fold the outside rear view mirror depress the button.
- To unfold it, depress the button again.

### CAUTION

The electric type outside rear view mirror operates even though the ignition switch or ENGINE START/ STOP button is in the LOCK or OFF position. However, to prevent unnecessary battery discharge, do not adjust the mirrors longer than necessary while the engine is not running.

### CAUTION

In case it is an electric type outside rear view mirror, don't fold it by hand. It could cause motor failure.

### Reverse parking aid function (if equipped)

When you shift the gear to the R (Reverse) position, the outside rear view mirror(s) will rotate downwards to aid with driving in reverse.



The position of the outside rear view mirror switch (1) determines whether or not the mirrors will move:

**Left/Right:** When either the L (Left) or R (Right) switch is selected, both outside rear view mirrors will move.

**Neutral:** When neither switch is selected, the outside rear view mirrors will not move.

The outside rear view mirrors will automatically revert to their original positions if any of the followings occur:

- The ignition switch or ENGINE START/ STOP button is placed to either the LOCK/OFF position or the ACC position.
- The gear is shifted to any position except R (Reverse).

- The remote control outside rear view mirror switch is not selected.

### Auto reverse user settings

If you cannot secure enough visibility with the angles provided as factory default conditions, you can readjust and store the angles of outside rear view mirrors.

The factory default angles of the right and left rear view mirrors might be set differently to improve visibility.

1. Set the shifter dial to P (Parking).  
Make sure that the vehicle is stopped and the mirrors are not working.
  2. Position the lever to L (left) or R (right) depending on the mirror that you want to adjust.
  3. Step on the brake pedal and shift the shifter dial to R (Reverse).
  4. When the downward movement of the rear view mirror is finished, adjust the mirror to the desired angle by pressing the switches, ▼, ▲, ◀, ▶.
  5. If you shift the shifter dial to a position other than R (Reverse), or change the rear view mirror selector lever to the neutral position, and the automatic return of the mirror is finished, the adjusted angle will be automatically saved.
  6. You can adjust the rear view mirror on the other side by following the same procedures (1-5).
2. Choose the mirror to be adjusted by positioning the lever to L (left) or R (right).
  3. Step on the brake pedal and shift the shifter dial to R (Reverse).
  4. When the downward movement of the rear view mirror is finished, press the switch ▲ to locate the mirror in the position higher than before (P, N or D).  
(Adjust the mirror in the higher position compared to its position in the driving mode)
  5. It is initialized when the shifter dial is shifted to a position other than R (Reverse), or the rear view mirror selector lever is changed to the neutral position. (Initialized position will be applied from next operation)
  6. You can initialize settings for the mirror on the other side by following the same procedures (1-5).

### ⚠ CAUTION

We recommend following the procedures in an orderly manner to change or initialize the auto reversing user settings. If you move to the next step before completing the previous one, the changed angle may not be changed or initialization may not work properly.

### How to reset auto reverse user settings

If you want to change the automatic control function of rear view mirrors to factory-default conditions, follow the steps below.

1. Shift the shifter dial to P (Park). Make sure that the vehicle is stopped and the mirror is not working.

## Instrument cluster

Type A

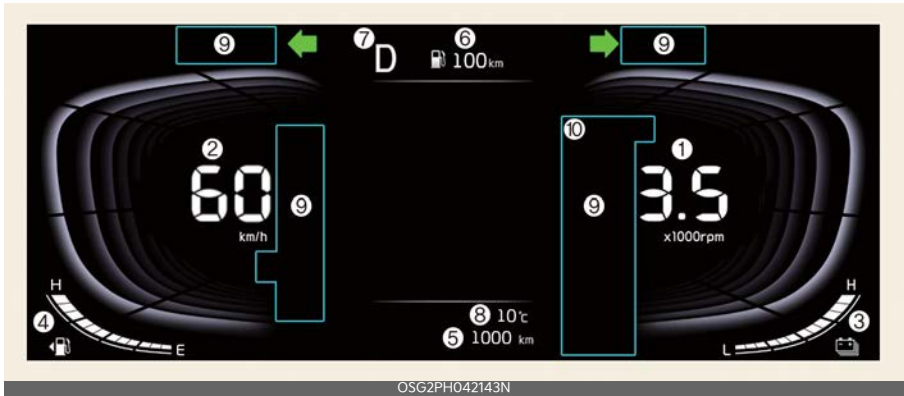

OSG2PH042143N

Type B



OSG2PH042144N

\* The actual cluster in the vehicle may differ from the illustration.

- 1 Tachometer/Power gauge
- 2 Speedometer
- 3 Hybrid battery SOC gauge
- 4 Fuel gauge
- 5 Odometer
- 6 Distance to empty
- 7 Transmission shift indicator
- 8 Outside temperature gauge
- 9 Warning and indicator lights
- 10 Plug-in hybrid mode indicator

## Full LCD cluster (if equipped)

The full LCD type cluster provides two themes.

### Type A

Type A is the basic theme of the full LCD type cluster and provides different graphic styles depending on drive mode.



### Type B (Dynamic)

Type B is set by the user and provides digital display. The background screen changes according to the weather and time.



- Weather: sunny, cloudy, rainy, snowy, foggy, lightning and clearing up (6 types)
- Time: night, day, sunrise and sunset (4 types)

You can change the theme by selecting 'Vehicle → Cluster → Select Theme' from Settings menu on the infotainment system screen.



**CAUTION**

The information is displayed after getting information from a weather information provider via GPS. Depending on conditions of GPS reception, the information may be different from the current weather in your area.

If no information is received via GPS (e.g., not subscribed to Kia Connect service), the weather and time will be displayed as 'sunny' and 'night' on the cluster.

**\* INFORMATION**

The infotainment system may change after software updates. For more information, refer to the user's manual provided in the infotainment system and the quick reference guide.

**Adjusting instrument cluster illumination**

The brightness of the instrument panel illumination is changed by pressing the illumination control button ("+" or "-") when the ENGINE START/STOP button is ON, or the taillamps are turned on.



**WARNING**

Never adjust the instrument cluster while driving. This could result in loss of control and lead to an accident that may cause DEATH, SERIOUS INJURY, or property damage.

- If you hold the illumination control button ("+" or "-"), the brightness will be changed continuously.



A: Illumination

- If the brightness reaches to the maximum or minimum level, an alarm will sound.

**Gauges**

The gauges display various information such as the speed of the vehicle, and so on.

**Speedometer**

Type A



Type B (km/h) / (mph)



The speedometer indicates the speed of the vehicle and is calibrated in kilometers per hour (km/h) and miles per hour (mph).

### Power gauge

Type A



Type B



The hybrid system gauge indicates whether the current driving condition is fuel efficient or not.

- **CHARGE:**  
Shows that the energy made by the vehicle is being converted to electrical energy. (Regenerated energy)
- **ECO:**  
Shows that the vehicle is being driven in an Eco-friendly manner.
- **POWER:**  
Shows that the vehicle is exceeding the Eco-friendly range.

**\* NOTICE**

According to the hybrid system gauge area, the "EV" indicator comes on or off.

- "EV" indicator ON: Vehicle is driven using the electric motor or the gasoline engine is stopped.
- "EV" indicator OFF: Vehicle is driven using the gasoline engine.

### Hybrid battery SOC (State of Charge) gauge

Type A

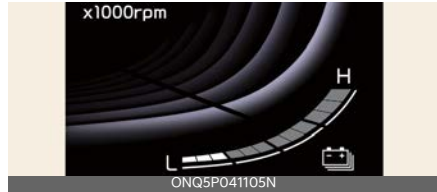

Type B



This gauge indicates the remaining hybrid battery power. If the SOC is near the "L (Low)" level, the vehicle automatically operates the engine to charge the battery.

However, if the Service Indicator (HEV) and Malfunction Indicator Lamp (MIL) turn on when the SOC gauge is near the "L (Low)" level, visit an authorized Kia dealer.

**\* NOTICE**

Never try to start the vehicle if the fuel tank is empty. In this condition, the engine cannot charge the high voltage battery of the hybrid system. If you try to start the vehicle when the fuel is empty, the high voltage battery will become discharged and be damaged.

### Plug-in hybrid mode indicator (Plug-in hybrid vehicle)

- CD (Charge Depleting, Electric) mode: The high-voltage (hybrid) battery is used to drive the vehicle.

Type A



Type B

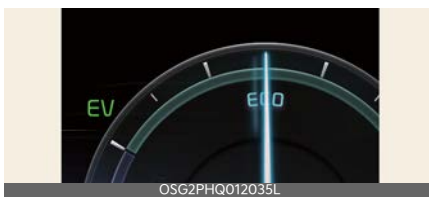

- EV+ (Electric +) mode: The high-voltage (hybrid) battery is only used to drive the vehicle. (Except completely depressing the accelerator pedal)

Type A



Type B

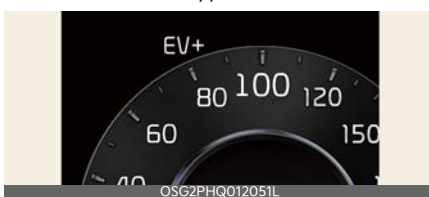

- AUTO mode: The AUTO mode will be automatically selected from either

from Electric (CD) mode or Hybrid (CS) mode by the system according to the driving condition.

Type A



Type B

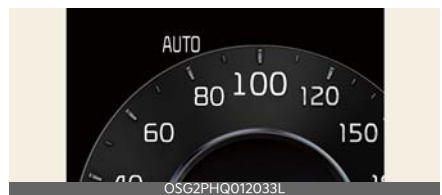

- CS (Charge Sustaining, Hybrid) mode: The high-voltage (hybrid) battery and gasoline engine is used to drive the vehicle.

Type A



Type B

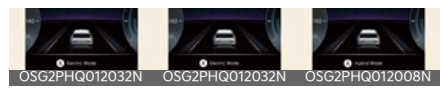
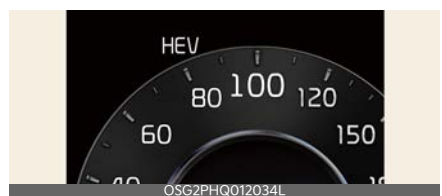

5

A corresponding message is displayed to indicate the selected mode.

### Fuel gauge

Type A / Type B



This gauge indicates the approximate amount of fuel remaining in the fuel tank.

#### \* NOTICE

- The fuel tank capacity is given in "Recommended lubricants and capacities" on page 9-6.
- The fuel gauge is supplemented by a low fuel warning light, which will appear when the fuel tank is nearly empty.
- On inclines or curves, the fuel gauge pointer may fluctuate or the low fuel warning light may come on earlier than usual due to the movement of fuel in the tank.

#### ⚠ WARNING

### Fuel gauge

Running out of fuel can expose vehicle occupants to danger.

You must stop and obtain additional fuel as soon as possible after the warning light comes on or when the gauge indicator comes close to the "E" level.

#### ⚠ CAUTION

Avoid driving with an extremely low fuel level. Running out of fuel could cause

the engine to misfire, which could damage the catalytic converter.

#### \* NOTICE

The fuel display may not be accurate if the vehicle is on an incline.

### Odometer

Type A / Type B



The odometer indicates the total distance that the vehicle has been driven and should be used to determine when periodic maintenance should be performed.

- Odometer range: 0~1,599,999 km or 999,999 miles.

### Distance to empty

Type A / Type B



- The distance to empty is the estimated distance the vehicle can be driven with the remaining fuel.
  - Distance range: 1~9,999 km or 1~9,999 mi.
- If the estimated distance is below 1 mile (1 km), the trip computer will display "---" as distance to empty.

- If the level of the remaining fuel is more than three-quarters, more than 3 liters (0.8 gallons) of fuel must be refilled for the fuel gauge to change. In other cases, more than 6 liters (1.6 gallons) of fuel must be refilled for the vehicle to change the fuel gauge.

**\* NOTICE**

- If the vehicle is not on level ground or the battery power has been interrupted, the distance to empty function may not operate correctly.
- The distance to empty may differ from the actual driving distance as it is an estimate of the available driving distance.
- The trip computer may not register additional fuel if less than 6 liters (1.6 gallons) of fuel are added to the vehicle.
- The fuel economy and distance to empty may vary significantly based on driving conditions, driving habits, and condition of the vehicle.

**Outside temperature gauge**

Type A



Type B



This gauge indicates the current outside air temperatures by 1 °C (1 °F).

- Temperature range: -40 °C~60 °C (-40 °F~140 °F)

The outside temperature on the display may not change immediately like a general thermometer to prevent the driver from being inattentive.

To change the temperature unit (from °C to °F or from °F to °C)

The temperature unit can be changed by using the 'User Settings' mode of the LCD Display.

\* For more details, refer to "LCD display" on page 5-82.

**Transmission shift indicator**

Transmission shift indicator displays gear information depending on your vehicle's transmission type.

**Dual clutch transmission shift indicator (if equipped)**

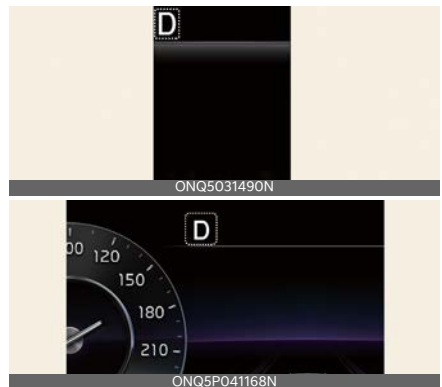

This indicator displays which shift position is selected.

- Park: P
- Reverse: R
- Neutral: N
- Drive: D

## Shift indicator pop-up

The pop-up that indicates the current gear position is displayed in the cluster for about 2 seconds when shifting into other positions (P/R/N/D).



The shift indicator pop-up function can be activated or deactivated from the User Settings mode in the cluster LCD display.

## LCD display

The LCD display modes can be changed with the control buttons.

### LCD Display Control



- 1 : MODE button for changing modes
- 2 : MOVE switch for changing items
- 3 OK: SELECT/RESET button for setting or resetting the selected item

### LCD display modes

The LCD display provides 5 modes. You can switch modes by pressing the Mode button.

Type A

		Mode				
		Driving Assist	Trip Computer	Turn By Turn (TBT)*	User Settings*	Information/Master Warning
^ v Up/ Down	Lane Keeping Assist Smart Cruise Control* Lane Following Assist Highway Driving Assist*	Range*1	Route Guidance	Driver Assistance*	TPMS	
	Drive Info	Destination Info	Eco Vehicle	Engine Temperature		
	Since Refueling	The Master Warning mode displays warning messages related to the vehicle when one or more systems is not operating normally.	Head-Up Display			
	Accumulated Info		Cluster			
	Energy Flow		Lights*			
			Door*			
			Convenience*			
			Units			
			Language			
			Reset			

Type B

		Mode			
		Driving Assist	Trip Computer	Turn By Turn (TBT)*	Information/Master Warning
^ v Up/ Down	Forward Collision-Avoidance Assist Lane Keeping Assist Blind-Spot Collision-Avoidance Assist* Smart Cruise Control* Lane Following Assist Highway Driving Assist*	Range*1	Route Guidance	TPMS	
	Drive Info	Destination Info	Engine Temperature		
	Since Refueling	The Master Warning mode displays warning messages related to the vehicle when one or more systems is not operating normally.			
	Accumulated Info				
	Energy Flow				
	TPMS				
	Digital Speedometer				

The information provided may differ depending on which functions are applicable to your vehicle.

\* : if equipped

\* 1: For Plug-in Hybrid vehicle

**\* NOTICE**

Keep the engine running when configuring the display settings to prevent the battery from discharging.

**Trip computer mode**



A: Drive info

- 1 Accumulated trip distance
- 2 Total driving time
- 3 Average fuel efficiency

The trip computer mode displays information related to vehicle driving parameters including fuel economy, tripmeter information and timer.

\* For more details, refer to "Trip information (trip computer)" on page 5-92.

**Turn By Turn (TBT) mode**



This mode displays the state of the navigation.

**Driving Assist mode**



This mode displays the state of:

- Lane Safety
- Smart Cruise Control

**Information mode**

**Tire Pressure**



A: **Tire Pressure**

This mode displays the state of:

- Engine temperature
- Tire pressure
- AWD traction (if equipped)

**Tire pressure status**

This mode displays information related to Tire Pressure.

\* For more details, refer to "Tire Pressure Monitoring System (TPMS)" on page 7-9.



## Master warning mode



### A: Check headlamp LED



This warning light informs the driver the following situations.

- LED headlamp malfunction
- Lamp malfunction
- High Beam Assist malfunction (if equipped)

At this time, a Master Warning icon (⚠️) will appear beside the User Settings icon (⚙️), on the LCD display. If the warning situation is solved, the master warning light will be turned off and the Master Warning icon will disappear.

## User settings mode

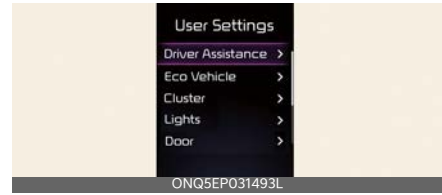

In this mode, you can change the settings of the instrument cluster, doors, lamps, etc.

1. Driver Assistance
2. Eco Vehicle
3. Cluster
4. Lights
5. Door
6. Convenience
7. Units
8. Language
9. Reset

The information provided may differ depending on which functions are applicable to your vehicle.

# 1. Driver Assistance

Items	Explanation
Driving Convenience	<ul style="list-style-type: none"> <li>Smart Cruise Control To adjust Smart Cruise Control * For more details, refer to "Smart Cruise Control (SCC) (if equipped)" on page 6-118.</li> <li>Highway Driving Assist To activate or deactivate Highway Driving Assist. * For more details, refer to "Highway Driving Assist (HDA) (if equipped)" on page 6-139.</li> <li>Highway Auto Speed Change To activate or deactivate Navigation-based Smart Cruise Control. * For more details, refer to "Navigation-based Smart Cruise Control (NSCC) (if equipped)" on page 6-131.</li> </ul>
Speed Limit*	<ul style="list-style-type: none"> <li>Speed Limit Offset To adjust the Speed Limit Offset</li> <li>Speed Limit Assist/Speed Assist Warning/Off To select the function of Intelligent Speed Limit Assist * For more details, refer to "Intelligent Speed Limit Assist (ISLA) (if equipped)" on page 6-104.</li> </ul>
Warning Volume	<ul style="list-style-type: none"> <li>High/Medium/Low To select the Warning Volume</li> </ul>
Driver Attention Warning	<ul style="list-style-type: none"> <li>Leading Vehicle Departure Alert</li> <li>Inattentive Driving Warning To activate or deactivate functions of Driver Attention Warning * For more details, refer to "Driver Attention Warning (DAW)" on page 6-110.</li> </ul>
Driving Safety*	<ul style="list-style-type: none"> <li>Forward Safety To activate or deactivate Forward Collision-Avoidance Assist * For more details, refer to "Forward Collision-Avoidance Assist (FCA) (Front Camera Only) (if equipped)" on page 6-58 and "Forward Collision-Avoidance Assist (FCA) (Sensor Fusion) (if equipped)" on page 6-68.</li> <li>Forward Safety Warning Timing To select the Forward Safety Warning Timing * For more details, refer to "Forward Collision-Avoidance Assist (FCA) (Front Camera Only) (if equipped)" on page 6-58 and "Forward Collision-Avoidance Assist (FCA) (Sensor Fusion) (if equipped)" on page 6-68.</li> <li>Lane Safety To activate or deactivate Blind-Spot Collision-Avoidance Assist * For more details, refer to "Lane Keeping Assist (LKA)" on page 6-80.</li> <li>Blind-Spot Safety To activate or deactivate Lane Keeping Assist * For more details, refer to "Blind-Spot Collision-Avoidance Assist (BCA) (if equipped)" on page 6-85.</li> <li>Exit Safety To activate or deactivate Lane Keeping Assist * For more details, refer to "Safe Exit Warning (SEW) (if equipped)" on page 6-94 or "Safe Exit Assist (SEA) (if equipped)" on page 6-98.</li> </ul>

Items	Explanation
Parking Safety*	<ul style="list-style-type: none"> <li>• Parking Distance Warning Auto On</li> <li>• Rear Cross-Traffic Safety</li> </ul> To activate or deactivate Rear Cross-Traffic Collision-Avoidance Assist. * For more details, refer to "Rear Cross-Traffic Collision-Avoidance Assist (RCCA) (if equipped)" on page 6-149.

\* The information provided may differ depending on which systems are applicable to your vehicle.

## 2. Eco Vehicle

Items	Explanation
Green Zone EV Drive	Activate or Deactivate
Coasting Guidance	<ul style="list-style-type: none"> <li>• Enable/disable Coasting Guide</li> <li>• Sound On/Sound Off</li> </ul> To select the Coasting Guidance.
Start coasting	<ul style="list-style-type: none"> <li>• Early/Normal/Late</li> </ul> To select the Start Coasting.
Smart Regeneration	Activate or Deactivate
Locking Charging Cable*	<ul style="list-style-type: none"> <li>• Always lock/Lock while charging/Do not lock</li> </ul> To select the Locking Charging Cable
Charge Guidance Sound*	<ul style="list-style-type: none"> <li>• High/Medium/Low/Off</li> </ul> To select the Charge Guidance Sound.

\* : for plug-in hybrid vehicle

## 3. Head-Up Display

Items	Explanation
Enable Head-Up Display	Activate or Deactivate
Display Height	<ul style="list-style-type: none"> <li>• Level 1-20</li> </ul>
Rotation	<ul style="list-style-type: none"> <li>• -5~+5 level</li> </ul>
Brightness	Level 1-20
Content Selection	To select the content to be displayed.

## 4. Cluster

Items	Explanation
Theme Selection	<ul style="list-style-type: none"> <li>• Link to Drive Mode Theme A/Theme B/Theme C</li> </ul> If this item is checked, the cluster theme will change accordingly.
Wiper/Lights Display	Activate or Deactivate
Traffic Signs	Activate or Deactivate
Icy Road Warning	Activate or Deactivate

Items	Explanation
Cluster Voice Guidance Volume	<ul style="list-style-type: none"> <li>0~3 Level</li> </ul> To adjust the Cluster Voice Guidance Volume.
Welcome Sound	Activate or Deactivate

## 5. Lights

Items	Explanation
Illumination	<ul style="list-style-type: none"> <li>1~20 Level</li> </ul> To adjust the instrument cluster illumination.
One Touch Turn Signal	<ul style="list-style-type: none"> <li>Off: The one touch turn signal function will be deactivated.</li> <li>3, 5, 7 flashes: The turn signal indicator will blink 3, 5, or 7 times when the turn signal lever is moved slightly.</li> </ul> * For more details, refer to "Lighting" on page 5-113.
Ambient Light Brightness	<ul style="list-style-type: none"> <li>4/3/2/1/Off</li> </ul> To adjust the brightness of Ambient Light.
Ambient Light Color	<ul style="list-style-type: none"> <li>7 colors/Link to Drive Mode</li> </ul> To select the color of Ambient Light.
Headlamp Delay	If this item is checked, the headlamp delay function will be activated.
High Beam Assist	If this item is checked, High Beam Assist will be activated. * For more details, refer to "High Beam Assist (HBA)" on page 5-117.

\* The information provided may differ depending on which functions are applicable to your vehicle.

## 6. Door

Items	Explanation
Automatically Lock	<ul style="list-style-type: none"> <li>Enable on shift: All doors will be automatically locked if the vehicle is shifted from the P (Park) position to the R (Reverse), N (Neutral), or D (Drive) position. (With the Engine ON, it is activated.)</li> <li>Enable on speed: All doors will be automatically locked when the vehicle speed exceeds 15 km/h (9.3 mph)</li> <li>Off: The auto door unlock operation will be canceled.</li> </ul> * If the setting is changed while the vehicle is in motion, the changed setting may not immediately operate.
Automatically Unlock	<ul style="list-style-type: none"> <li>On shift to P: All doors will be automatically unlocked if the gear is shifted from R (Reverse), N (Neutral), or D (Drive) position to P (Park) position. (With the Engine ON, it is activated.)</li> <li>Vehicle Off (for smart key): All doors will be automatically unlocked when the ENGINE START/STOP button is set to the OFF position.</li> <li>On key out (except smart key): All doors will be automatically unlocked when the ignition key is removed from the ignition switch.</li> <li>Off: The auto door unlock operation will be canceled.</li> </ul>
2 Press Unlock	If this item is checked, the two press unlock will be activated. Press the door unlock button once to unlock the driver's door, and press the button once more within 4 seconds to unlock the rest of the doors.
Horn Feedback	To Select the functions.
Power Liftgate	If this item is checked, Power Liftgate will be activated.
Power Liftgate Opening Speed	<ul style="list-style-type: none"> <li>Fast/Normal</li> </ul> To select the power liftgate speed.

Items	Explanation
Power Liftgate Opening Height	<ul style="list-style-type: none"> <li>Level 1/Level 2/Level 3/Full Open/User Height Setting</li> </ul> To select the height. * For more details, refer to "Power liftgate (if equipped)" on page 5-37.
Smart Liftgate	To activate or deactivate the Smart Liftgate. * For more details, refer to "Smart Liftgate with Auto Open (if equipped)" on page 5-42.
Remote Window Control (if equipped)	Activate To select the functions.

\* The information provided may differ depending on which systems are applicable to your vehicle.

## 7. Convenience

Items	Explanation
Seat Easy Access	<ul style="list-style-type: none"> <li>Off/Normal/Extended</li> </ul> To select the seat movement
Rear Occupant Alert	If this item is checked, the Rear Occupant Alert (ROA) display will be activated.
Service Interval	<ul style="list-style-type: none"> <li>Enable Service Interval/Adjust Interval/Reset</li> </ul> To select the Service Interval.
Oil Change Reminder	<ul style="list-style-type: none"> <li>Reset</li> </ul> To reset the remaining oil life.
Welcome Mirror/Light	<ul style="list-style-type: none"> <li>On Door Unlock/On Driver Approach</li> </ul> To select the welcome mirror/light function.
Wireless Charging System	Activate or Deactivate
Auto Rear Wiper (in R)	If this item is checked, the Auto Rear Wiper will be activated when the front wiper is On and the gear is selected in R (Reverse).

\* The information provided may differ depending on which functions are applicable to your vehicle.

## 8. Units

Items	Explanation
Speed Unit	<ul style="list-style-type: none"> <li>mph, km/h</li> </ul> To select the Speedometer unit.
Temperature Unit	<ul style="list-style-type: none"> <li>°F/°C</li> </ul> To select the Temperature unit.
Fuel Economy Unit	<ul style="list-style-type: none"> <li>US gallon, UK gallon</li> </ul> To select the Fuel economy unit. For more details, refer to "Trip information (trip computer)" on page 5-92.
Tire Pressure Unit	<ul style="list-style-type: none"> <li>psi, kPa, bar</li> </ul> To select the Tire Pressure Unit

\* The information provided may differ depending on which functions are applicable to your vehicle.

## 9. Language

Items	Explanation
Language	To select the language.

## 10. Reset

Items	Explanation
Reset	You can reset the menus in the User Settings mode. All menus in the User Settings mode are reset to factory settings, except language and service interval.

\*: if equipped

## Vehicle settings (infotainment system) (if equipped)



1. Press the **Setup** button on the head unit of the infotainment system.
2. Select **Vehicle** and change the setting of the features.

Vehicle Settings in the infotainment system provides user options for a variety of settings including door lock/unlock features, convenience features, driver assistance settings, etc.

- **Vehicle Settings**
  - **Driver Assistance**
  - **Eco Vehicle**
  - **Head-Up Display**
  - **Cluster**
  - **Climate**
  - **Lights**
  - **Door**
  - **Digital Key**
  - **Convenience**
  - **Units**
  - **Language**
  - **Reset**

### **WARNING**

Do not operate the **Vehicle settings** while driving. This may cause distraction resulting in an accident.

### \* **NOTICE**

The information provided may differ depending on which features are applicable to your vehicle.

### \* **INFORMATION**

The infotainment system may change after software updates. For more information, refer to the user's manual provided in the infotainment system and the quick reference guide.

## Driver Assistance settings (infotainment system) (if equipped)

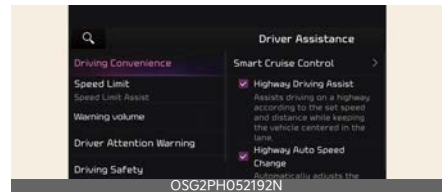

select **Setup** → **Vehicle** → **Driver Assistance** on the infotainment system screen to set the Driver Assistance function.

- **Driver Assistance**
  - **Driving Convenience**
  - **Speed Limit**
  - **Warning Volume**
  - **Driver Attention Warning**
  - **Driving Safety**
  - **Parking Safety**

### \* **INFORMATION**

The infotainment system may change after software updates. For more information, refer to the user's manual provided in the infotainment system and the quick reference guide.

## LCD displays

LCD displays show the following information to drivers.

- Trip information
- LCD modes
- Warning messages

## Trip information (trip computer)

The trip computer is a microcomputer-controlled driver information system that displays information related to driving.

### \* NOTICE

Some driving information stored in the trip computer resets if the battery is disconnected.

## Trip modes

Type A

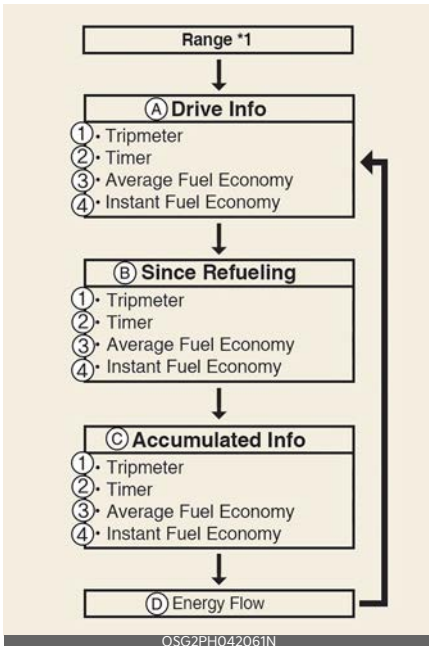

OSG2PH042061N

Type B

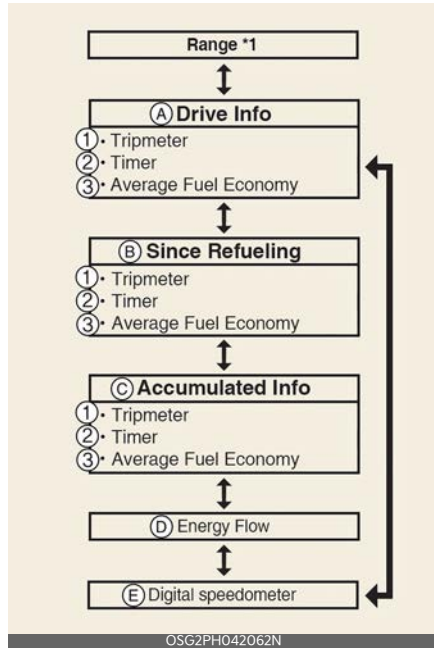

OSG2PH042062N

- A: Drive Info
- B: Since Refueling
- C: Accumulated Info
- D: Energy Flow
- E: Digital speedometer

- 1 Tripmeter
- 2 Timer
- 3 Average Fuel Economy
- 4 Instant Fuel Economy

To change the trip mode, toggle the switch (∧ / ∨) on the steering wheel.

\*: if equipped

\* 1: For Plug-In Hybrid vehicle



## Fuel economy

This information is always displayed at the bottom center of the Full LCD cluster.

### Average Fuel Economy (1)



1 Average fuel economy

2 Instant fuel economy

- The average fuel economy is calculated by the total driving distance and fuel consumption since the last average fuel economy resets.
  - Fuel economy range: L/100 km or 0~99.9 mpg

#### \* NOTICE

The average fuel economy is not displayed for more accurate calculation if the vehicle does not drive more than 10 seconds or 50 m (0.03 mi) since the ignition switch or ENGINE START/STOP button is turned to ON.

### Instant Fuel Economy (2)

- This mode displays the instant fuel economy during the last few seconds when the vehicle speed is more than 10 km/h (6.2 mph).
  - Fuel economy range: 0.0 ~ 30 km/L, L/100 km or 0.0 ~ 50.0 mpg

## Drive Info display

This display shows the trip distance (1), the average fuel efficiency (2), and the total driving time (3) information once per one ignition cycle.

### Type A



### Type B

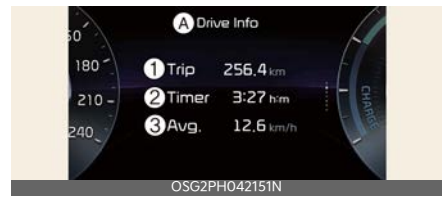

### A: Drive info

- 1 Accumulated trip distance
- 2 Total driving time
- 3 Average fuel efficiency
- 4 Instant fuel efficiency

- Fuel efficiency is calculated after the vehicle has run for more than 300 m (0.19 miles).
- The information will automatically reset when the driver's door is opened after the ignition is turned off, or approximately 3 minutes have passed after the ignition is turned off.
- If the engine is running, even when the vehicle is not in motion, the information will be accumulated.

## Information since refueling

Type A



Type B



### A: Since refueling

- 1 Accumulated trip distance
- 2 Total driving time
- 3 Average fuel efficiency
- 4 Instant fuel efficiency

This display shows the trip distance, the average fuel efficiency, and the instant fuel efficiency (or the total driving time) since refueling.

- Information since refueling is calculated after the vehicle has run for more than 300 m (0.19 miles).
- If you press "OK" button for more than 1 second after the information since refueling is displayed, the information will be reset.
- If the engine is running, even when the vehicle is not in motion, the information will be accumulated.

### \* NOTICE

The vehicle must be driven for a minimum of 300 m (0.19 miles) since the last ignition cycle before the average accu-

mulated driving information is recalculated.

## Accumulated driving information mode

This display shows the accumulated trip distance, the average fuel efficiency, and the total driving time.

Type A

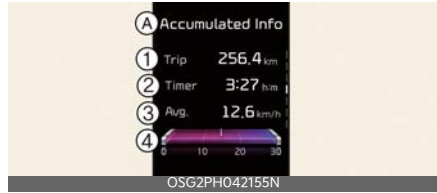

Type B

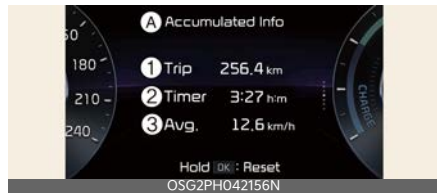

### A: Accumulated info

- 1 Accumulated trip distance
  - 2 Total driving time
  - 3 Average fuel efficiency
  - 4 Instant fuel efficiency
- Accumulated information is calculated after the vehicle has run for more than 300 m (0.19 miles).
  - If you press "OK" button for more than 1 second after the Cumulative Information is displayed, the information will be reset.
  - If the engine is running, even when the vehicle is not in motion, the information will be accumulated.

### Digital speedometer

This digital speedometer display shows the speed of the vehicle.



### Service interval

This mode reminds you of scheduled maintenance information.

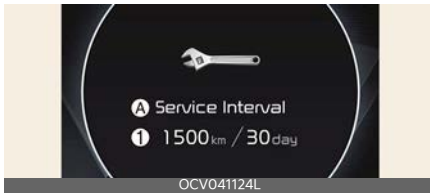

#### A: Service Interval

##### 1 Service interval schedule

### Service Interval

It calculates and displays when you need a scheduled maintenance service (mileage or days).

If the remaining mileage or time reaches 1,500 km (900 miles) or 30 days, "Service interval" message is displayed for several seconds each time you set the ignition switch or ENGINE START/STOP Button to the ON position.

### Service required

If you do not have your vehicle serviced according to the already input service interval, "Service required" message is displayed for several seconds each time you set the ignition switch or ENGINE START/STOP Button to the ON position.

To reset the service interval to the mileage and days you input before:

- Select 'Vehicle settings → Service Interval → Reset'.

#### \* NOTICE

If any of the following conditions occur, the mileage and days may be incorrect.

- The battery terminal is disconnected (For plug-in hybrid vehicle).
- The battery connector is disconnected (For hybrid vehicle)
- The battery is discharged.

#### \* INFORMATION

The infotainment system may change after software updates. For more information, refer to the user's manual provided in the infotainment system and the quick reference guide.

### Range (Plug-in hybrid vehicle)

The range is the estimated distance the vehicle can be driven with the remaining high-voltage (hybrid) battery (1, Electric) and fuel in the fuel tank (2, Gasoline).

#### Type A

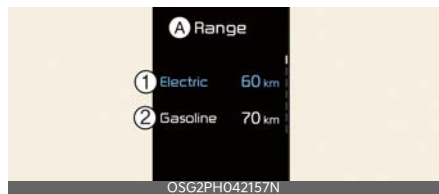

#### Type B

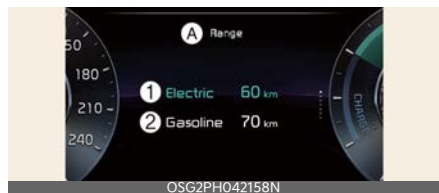

#### A: Range

- 1 Estimated distance with the remaining high-voltage (hybrid) battery (Electric)
  - 2 Estimated distance with the fuel in the fuel tank (Gasoline)
- If the estimated distance is below 1 km (1 mile), the trip computer will display "---" as distance to empty.
    - Distance range: 1 ~ 510 km or 1 ~ 510 miles.

**\* NOTICE**

- If the vehicle is not on level ground or the battery power has been interrupted, the range function may not operate correctly.
- The range may differ from the actual driving distance as it is an estimate of the available driving distance.
- The trip computer may not register additional fuel if less than 1.6 gallons (6 liters) of fuel are added to the vehicle.
- The range may vary significantly based on driving conditions, driving habits, and condition of the vehicle.

**Energy flow**



**A: Hybrid Mode**

The hybrid system informs the driver about its energy flow in various operating modes. While driving, the current energy flow is specified in 11 modes.

\* For more details, refer to "Energy flow" on page 1-29.

**LCD display messages**

**Door, hood, liftgate, sunroof open**

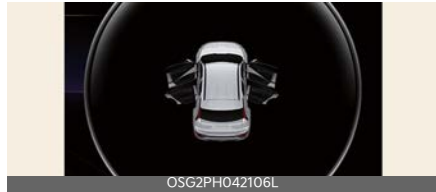

This warning is displayed indicating which door, the hood, the liftgate or the sunroof is open.

**Low pressure warning display**



**A: Low tire pressure**

This warning message is displayed if the tire pressure is low. The corresponding tire on the vehicle will appear.

\* For more details, refer to "Tire Pressure Monitoring System (TPMS)" on page 7-9.

**Lights mode**



**A: Lights**

1

2 

3 AUTO

4 OFF

This indicator displays which exterior light is selected using the lighting control.

You can activate or deactivate Wiper/Lights Display function from the User Settings mode in the cluster LCD display.

### Wiper mode



A: **Front Wiper**

1 OFF

2 AUTO

3 LO

4 HI

This indicator displays which wiper speed is selected using the wiper control.

You can activate or deactivate Wiper/Lights Display function from the User Settings mode in the cluster LCD display.

### Low washer fluid

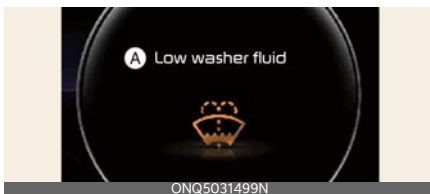

A: **Low washer fluid**

This warning message is displayed if the washer fluid level in the reservoir is nearly empty.

Have the washer fluid reservoir refilled.

### Icy road warning



A: **Ice possible. Drive with care**

This warning is to warn the driver the road may be icy.

When the following conditions occur, the warning light (including outside temperature gauge) blinks 5 times and then appears, and also warning chime sounds once.

- The temperature on the outside temperature gauge is below approximately 4 °C (40 °F).

### \* NOTICE

If the icy road warning appears while driving, you should drive more attentively and safely refraining from overspeeding, rapid acceleration, sudden braking or sharp turning, etc.

### Engine overheated

- This warning message appears when the engine coolant temperature is above 120 °C (248 °F). This means that the engine is overheated and may be damaged.

\* If your vehicle is overheated, refer to "If the engine overheats" on page 7-7.

## Low engine oil

- This warning message appears when the engine oil level is insufficient.
  - Refill the engine oil.
- \* For more details, refer to "Engine oil" on page 8-15.

### **⚠ WARNING**

When the engine oil level warning light occurs, it is necessary to check whether maintenance schedule (Engine oil replacement) in owner's manual has been followed before replenishing the oil, and if not followed, the engine oil must be replaced first.

## Engine oil change due soon. Reset oil life after oil change

- This warning message appear when the remaining engine oil life reaches 5% or below.
- Replace engine oil from an authorized Kia dealer. After that, select 'Convenience → Oil Change Reminder' from the User Settings menu on the cluster or 'Vehicle → Cluster → Oil Change Reminder' from Settings menu on the infotainment system screen to reset the remaining oil life.

\* For more details, refer to "Engine oil" on page 8-15.

### **\* INFORMATION**

The infotainment system may change after software updates. For more information, refer to the user's manual provided in the infotainment system and the quick reference guide.

## Engine oil change due now. Reset oil life after oil change

- This warning message appear when the remaining engine oil life reaches 1% or below.
- Replace engine oil immediately from an authorized Kia dealer. After that, select 'Convenience → Oil Change Reminder' from the User Settings menu on the cluster or 'Vehicle → Cluster → Oil Change Reminder' from Settings menu on the infotainment system screen to reset the remaining oil life.

\* For more details, refer to "Engine oil" on page 8-15.

### **\* INFORMATION**

The infotainment system may change after software updates. For more information, refer to the user's manual provided in the infotainment system and the quick reference guide.

## Low key battery (for smart key system)

- This warning message appears if the battery of the smart key is discharged when the ENGINE START/STOP Button changes to the OFF position.

## Press START button while turning wheel (for smart key system)

- This warning message appears if the steering wheel does not unlock normally when the ENGINE START/STOP Button is pressed.
- It means that you should press the ENGINE START/STOP Button while turning the steering wheel right and left.

### **Steering wheel not locked (for smart key system)**

- This warning message appears if the steering wheel does not lock when the ENGINE START/STOP Button changes to the OFF position.

### **Check steering wheel lock system (for smart key system)**

- This warning message appears if the steering wheel does not lock normally when the ENGINE START/STOP Button changes to the OFF position.

### **Key not in vehicle (for smart key system)**

- This warning message appears if the smart key is not in the vehicle when you press the ENGINE START/STOP Button.
- It means that you should always have the smart key with you.

### **Key not detected (for smart key system)**

- This warning message appears if the smart key is not detected when you press the ENGINE START/STOP Button.

### **Shift to P or N to start engine (for smart key system)**

- This warning message appears if you try to start the engine with the gear not in the P (Park) or N (Neutral) position.

### **Press brake pedal to start engine (for smart key system)**

- This warning message appears if the ENGINE START/STOP Button changes to the ACC position twice by pressing the button repeatedly without depressing the brake pedal.
- It means that you should depress the brake pedal to start the engine.

### **Battery discharging due to external electrical devices**

The vehicle can detect self-discharge of the battery due to over-current that is generated by unauthorized electrical devices such as dashboard camera (dash cam) mounting during parking.

If the warning continues even after external electrical devices are removed, have your vehicle inspected by an authorized Kia dealer.

### **Press START button again (for smart key system)**

- This warning message appears if you can not operate the ENGINE START/STOP Button when there is a problem with the ENGINE START/STOP Button system.
- It means that you could start the engine by pressing the ENGINE START/STOP button once more.
- If the warning appears each time you press the ENGINE START/STOP Button, have the vehicle inspected by an authorized Kia dealer.

### **Press START button with key (for smart key system)**

- This warning message appears if you press the ENGINE START/STOP Button while the warning message "Key not detected" is appeared.
- At this time, the immobilizer indicator light blinks.

### **Unplug vehicle to start (Plug-in hybrid vehicle)**

The message is displayed when you start the engine without unplugging the charging cable. Unplug the charging cable, and then start the vehicle.

### **Remaining Time (Plug-in hybrid vehicle)**

The message is displayed to notify the remaining time to fully charge the battery.

### **Shift to P to charge (Plug-in hybrid vehicle)**

The message is displayed when the charging connector is plugged with the shift lever or dial in R (Reverse), N (Neutral) or D (Drive). Move the shift lever or dial to P (Park) and re-start the charging process.

### **Electric mode/Automatic mode/ Hybrid mode (Plug-in hybrid vehicle)**

A corresponding message is displayed when a mode is selected by pressing the HEV button.

### **Low battery. Maintaining Hybrid mode (Plug-in hybrid vehicle)**

This message is displayed when unable to convert to EV mode even when pressing the HEV button during HEV mode driving due to insufficient high-voltage (hybrid) battery level.

### **Low system temperature. Switching to Hybrid mode/ High system temperature. Switching to Hybrid mode (Plug-in hybrid vehicle)**

This message is displayed when the temperature of the high-voltage (hybrid) battery is too low or high.

This warning message is to protect the battery and the hybrid system.

### **Low system temperature. Maintaining Hybrid mode/ High system temperature. Maintaining Hybrid mode (Plug-in hybrid vehicle)**

This message is displayed when the temperature of the high-voltage (hybrid) battery is too low or too high. This warning message is to protect the battery and the hybrid system.

### **Wait until fuel door opens (Plug-in hybrid vehicle)**

This message is displayed when you attempt to open the fuel filler door with the fuel tank pressurized. Wait until the fuel tank is depressurized.



### **Fuel door open (Plug-in hybrid vehicle)**

This message is displayed when the fuel filler door opens after the fuel tank is depressurized. If this message is displayed, you can refuel the fuel tank.

### **Charging stopped. Check the AC charger (Plug-in hybrid vehicle)**

This messages is displayed when the charging failed by external charger error.

The purpose of this message is to let you know the error has occurred in the charger itself, not in the vehicle.

### **Charging stopped. Check the cable connection (Plug-in hybrid vehicle)**

This messages is displayed when charging is stopped because the charging connector is not correctly connected to the charging inlet. If this occurs, separate the charging connector and re-connect it and check whether there is any problem (external damage, foreign substances, etc.) with the charging connector and charging inlet. If the same problem occurs when charging the vehicle with a replaced charging cable or genuine Kia portable charger, have the vehicle inspected by an authorized Kia dealer.

### **Charging Door Open (Plug-in hybrid vehicle)**

This message indicates that the charging door is open while in driving-ready state to encourage you to inspect and close the door. (Driving with the charging door open may result in moisture inflow or damage. This message is used to prevent such occurrences.)

### **Switching to Hybrid mode to allow heating or air conditioning (Plug-in hybrid vehicle)**

- When the outdoor temperature is lower than -13 °C (9 °F) and the coolant temperature is lower than 40 °C (104 °F), you turn the climate control On for heating, the above message will be displayed in the cluster. Then, the vehicle will automatically switch to HEV mode and EV mode will not be activated (although EV button is pressed)
- When the outdoor temperature is higher than -10 °C (14 °F), or the coolant temperature is higher than 80 °C (176 °F) or you turn the climate control Off, the vehicle will automatically return to EV mode.

### **Switching to Hybrid mode for self-diagnosis (Plug-in hybrid vehicle)**

This message is displayed for self-diagnosis of the hybrid mode system.

## Low fuel

- This warning message is displayed if the fuel tank is almost out of fuel.
- When this message is displayed, the low fuel level warning light in the cluster will come on.
- It is recommended to look for the nearest fueling station and refuel as soon as possible.

## Warning and indicator lights

The warning light and indicator light indicate a situation where the driver should be careful and whether the various functions are activated.

### Warning lights

The warning light indicates situations that require the driver to pay attention.

#### \* NOTICE

### Warning lights

Make sure that all warning lights are OFF after starting the engine. If any light is still ON, this indicates a situation that needs attention.

### Air bag warning light

This warning light appears:

- Once you set the ignition switch or ENGINE START/STOP Button to the ON position.
  - It appears for approximately 3 ~ 6 seconds and then goes off.
- When there is a malfunction with the SRS. In this case, have the vehicle inspected by an authorized Kia dealer.

### Seat belt warning light

This warning light informs the driver that the seat belt is not fastened.

\* For more details, refer to "Seat belts" on page 4-17.

## Parking brake & brake fluid warning light

### This warning light appears:

- Once you set the ignition switch or ENGINE START/STOP Button to the ON position.
  - It appears for approximately 3 seconds
  - It remains on if the parking brake is applied.
- When the parking brake is applied.
- When the brake fluid level in the reservoir is low.
  - If the warning light appears with the parking brake released, it indicates the brake fluid level in reservoir is low.

### If the brake fluid level in the reservoir is low:

1. Drive carefully to the nearest safe location and stop your vehicle.
2. With the engine stopped, check the brake fluid level immediately and add fluid as required (For more details, refer to "Brake fluid" on page 8-14). Then check all brake components for fluid leaks. If any leak on the brake system is still found, the warning light remains on, or the brakes do not operate properly, do not drive the vehicle.

In this case, have your vehicle towed to an authorized Kia dealer and inspected.

## Dual-diagonal braking system

Your vehicle is equipped with dual-diagonal braking systems. This means you still have braking on two wheels even if one of the dual systems should fail.

With only one of the dual systems working, more than normal pedal travel and greater pedal pressure are required to stop the vehicle.

Also, the vehicle will not stop in as short a distance with only a portion of the brake system working.

If the brakes fail while you are driving, shift to a lower gear for additional engine braking and stop the vehicle as soon as it is safe to do so.

### \* NOTICE

## Parking brake & brake fluid warning light

Driving the vehicle with a warning light ON is dangerous. If the Parking Brake & Brake Fluid Warning Light appears with the parking brake released, it indicates that the brake fluid level is low.

In this case, have your vehicle inspected by an authorized Kia dealer.

## Anti-lock brake system (ABS) warning light

### This warning light appears:

- Once you set the ignition switch or ENGINE START/STOP button to the ON position.
  - It appears for approximately 3 seconds and then goes off.

- When there is a malfunction with the ABS (The normal braking system will still be operational without the assistance of the anti-lock brake system). In this case, have the vehicle inspected by an authorized Kia dealer.

**Electronic Brake Force Distribution (EBD) system warning light**



**These two warning lights appear at the same time while driving:**

- When the ABS and regular brake system are not working, have your vehicle inspected by an authorized Kia dealer.

**⚠ WARNING**

**Electronic Brake Force Distribution (EBD) system warning light**

When both ABS and parking brake & brake fluid warning lights are on, the brake system will not work normally and you may experience an unexpected and dangerous situation during sudden braking.

In this case, avoid high speed driving and abrupt braking.

Have your vehicle inspected by an authorized Kia dealer as soon as possible.

**Electronic Parking Brake (EPB) warning light **

**This warning light appears:**

- Once you set the ignition switch or ENGINE START/STOP button to the ON position.
  - It appears for approximately 3 seconds and then goes off.
- When there is a malfunction with the EPB. In this case, have the vehicle inspected by an authorized Kia dealer.

**\* NOTICE**

**Electronic Parking Brake (EPB) warning light**

The Electronic Parking Brake (EPB) warning light may appear when the Electronic Stability Control (ESC) Indicator Light comes on to indicate that the ESC is not working properly (This does not indicate malfunction of the EPB).

**Motor Driven Power Steering (MDPS) warning light **

**This warning light appears:**

- Once you set the ignition switch or ENGINE START/STOP Button to the ON position.
  - This indicator light comes on after the ignition switch or ENGINE START/STOP button is in the ON position and then goes out after approximately 3 seconds.
- When there is a malfunction with the EPS. In this case, have the vehicle inspected by an authorized Kia dealer.

## Charging system warning light



### This warning light appears:

- Once you set the ignition switch or ENGINE START/STOP button to the ON position.
- When there is a malfunction with either the alternator or electrical charging system.

### If there is a malfunction with either the alternator or electrical charging system:

1. Drive carefully to the nearest safe location and stop your vehicle.
2. Turn the engine off and check the alternator drive belt for looseness or breakage.

In this case, have the vehicle inspected by an authorized Kia dealer.

## Malfunction Indicator Lamp (MIL)



### This warning light appears:

- When you set the ignition switch or the ENGINE START/STOP button to the ON position.
  - The malfunction indicator light appears for about 3 seconds and then goes off.
- Whenever there is a malfunction with either the emission control system or the engine or the vehicle powertrain. If this occurs, have the vehicle inspected by an authorized Kia dealer.

### ⚠ CAUTION

#### Malfunction Indicator Lamp (MIL)

- Driving with the Malfunction Indicator Lamp (MIL) on may cause damage to the emission control systems which could effect drivability and/or fuel economy.
- If the enhanced engine protection system becomes activated due to lack of engine oil, engine power will be limited. If such condition continues repeatedly, the Malfunction Indicator Lamp will appear.

### ⚠ CAUTION

If the oil pressure lowers due to insufficient engine oil, etc., the engine oil pressure warning light turns on and an enhanced engine protection system that limits the engine's power is activated. After that, engine warning light turns on if driving repeatedly and continuously.

### ⚠ CAUTION

If the Malfunction Indicator Lamp (MIL) appears, potential catalytic converter damage is possible which could result in loss of engine power. In this case, have the vehicle inspected by an authorized Kia dealer.

## Engine oil pressure warning light



### This warning light appears:

- Once you set the ignition switch or ENGINE START/STOP Button to the ON position.
  - It remains on until the engine is started.
- When the engine oil pressure is low.

### If the engine pressure is low:

- Drive carefully to the nearest safe location and stop your vehicle.
- Turn the engine off and check the engine oil level (For more details, refer to "Engine oil and filter" on page 8-13). If the level is low, add oil as required.
- If the warning light remains on after adding oil or if oil is not available, have the vehicle inspected by an authorized Kia dealer. Continued driving with the warning light on may cause engine failure.

### \* NOTICE

- When engine oil pressure decreases due to insufficient engine oil, etc., the Engine Oil Pressure warning light will appear.
- The enhanced engine protection system which limits engine power will be activated. If the engine oil pressure is restored, the Engine Oil Pressure warning light and the enhanced engine protection system will turn off.
- The enhanced engine protection system which limits engine power will be activated. If the engine oil pressure is restored, the Engine Oil Pressure warning light and the enhanced engine protection system will turn off.

### ⚠ CAUTION

#### Engine overheating

Do not continue driving with the engine overheated. Otherwise, the engine may be damaged.

### ⚠ CAUTION

#### Engine damage

If the engine is not stopped immediately after the engine oil pressure warning light appears and stays on while the engine is running, serious engine damage may result.

## Exhaust system (GPF) warning light (Gasoline Engine)

### This warning light appears:

- When there is a malfunction with Gasoline Particulate Filter (GPF) system.
- When this warning light appears, it may turn off after driving the vehicle:
  - The vehicle should be driven for more than 30 minutes at a speed of 80 km/h (50 mph) and faster.
  - Ensure the following conditions are all met: safe road conditions, transmission 3rd gear or above, and engine speed of 1,500 - 4,000 rpm.

If this warning light blinks in spite of the procedure (at this time the LCD warning message will be displayed), have the GPF system checked by an authorized Kia dealer.

**⚠ CAUTION****Gasoline engine with GPF (if equipped)**

If you continue to drive with the GPF warning light blinking for a long time, the GPF system can be damaged and fuel consumption can worsen.

**Low fuel level warning light ****This warning light appears:**

When the fuel tank is nearly empty.

**If the fuel tank is nearly empty:**

Add fuel as soon as possible.

**⚠ CAUTION****Low fuel level**

Driving with the Low Fuel Level warning light on or with the fuel level below "E" can cause the engine to misfire and damage the catalytic converter.

**Master warning light ****This indicator light appears:**

- This warning light informs the driver the following situations
  - LED headlamp malfunction (if equipped)
  - Lamp malfunction
  - High Beam Assist malfunction (if equipped)

To identify the details of the warning look at the LCD display.

If the warning situation is solved, the master warning light will turn off.

**Low tire pressure warning light  (if equipped)****This warning light appears:**

- Once you set the ignition switch or ENGINE START/STOP button to the ON position.
    - It appears for approximately 3 seconds and then goes off.
  - When one or more of your tires are significantly under inflated. (The location of the underinflated tires are displayed on the LCD display).
- \* For more details, refer to "Tire Pressure Monitoring System (TPMS)" on page 7-9.

**This warning light remains on after blinking for approximately 60 seconds or repeats blinking on and off at the intervals of approximately 3 seconds:**

- When there is a malfunction with the TPMS.
    - In this case, have the vehicle inspected by an authorized Kia dealer.
- \* For more details, refer to "Tire Pressure Monitoring System (TPMS)" on page 7-9.

**⚠ WARNING****Low tire pressure**

- Significantly low tire pressure makes the vehicle unstable and can contribute to loss of vehicle control and increased braking distances.
- Continued driving with low pressure tires will cause the tires to overheat and fail.

**⚠ WARNING**

**Safe stopping**

- The TPMS cannot alert you about severe and sudden tire damage caused by external factors.
- If you notice any vehicle instability, immediately take your foot off the accelerator pedal, apply the brakes gradually with light force, and slowly move to a safe position off the road.

**LED headlamp warning light **

**This warning light appears:**

- Once you set the ENGINE START/ STOP button to the ON position.
  - It appears for approximately 3 seconds and then goes off.
- When there is a malfunction with the LED headlamp.

In this case, have the vehicle inspected by an authorized Kia dealer.

**This warning light blinks:**

- When there is a malfunction with a LED headlamp related part.

In this case, have the vehicle inspected by an authorized Kia dealer.

**⚠ CAUTION**

**LED headlamp warning light**

Continuous driving with the LED Headlamp Warning Light on or blinking can reduce LED headlamp (low beam) life.

**Forward Safety warning light **

**This indicator light appears:**

- Once you set the ENGINE START/ STOP button to the ON position.
  - It appears for approximately 3 seconds and then goes off.
- When there is a malfunction with Forward Collision-Avoidance Assist.

In this case, have the vehicle inspected by an authorized Kia dealer.

\* For more details, refer to "Forward Collision-Avoidance Assist (FCA) (Front Camera Only) (if equipped)" on page 6-58 or "Forward Collision-Avoidance Assist (FCA) (Sensor Fusion) (if equipped)" on page 6-68.

**Icy road warning light  (if equipped)**

This warning light is to warn the driver the road may be icy. When the temperature on the outside temperature gauge is approximately below 4 °C (39 °F) the Icy road warning light and outside temperature gauge blinks and then appears. Also, the warning chime sounds 1 time.

**Indicator lights**

**Electronic stability control (ESC) indicator light **

**This indicator light appears:**

- Once you set the ignition switch or ENGINE START/STOP Button to the ON position.
  - It appears for approximately 3 seconds and then goes off.



- When there is a malfunction with the ESC system.  
In this case, have the vehicle inspected by an authorized Kia dealer.

### This indicator light blinks:

While the ESC is operating.

- \* For more details, refer to "Electronic Stability Control (ESC) system" on page 6-48.

### Electronic stability control (ESC)

#### OFF indicator light

### This indicator light appears:

- Once you set the ignition switch or ENGINE START/STOP Button to the ON position.
    - It appears for approximately 3 seconds and then goes off.
  - When you deactivate the ESC system by pressing the ESC OFF button.
- \* For more details, refer to "Electronic Stability Control (ESC) system" on page 6-48.

### AUTO HOLD indicator light (AUTO HOLD)

#### This indicator light appears:

- **White** When you activate the auto hold system by pressing the AUTO HOLD button.
- **Green** When you stop the vehicle completely by depressing the brake pedal with the auto hold system activated.
- **Yellow** When there is a malfunction with the auto hold system. In this case,

have the vehicle inspected by an authorized Kia dealer.

- \* For more details, refer to "AUTO HOLD (if equipped)" on page 6-44.

### Immobilizer indicator light (without smart key) (if equipped)

#### This indicator light appears:

- When the vehicle detects the immobilizer in your key properly while the ignition switch is ON.
  - At this time, you can start the engine.
  - The indicator light goes off after starting the engine.

#### This indicator light blinks:

- When there is a malfunction with the immobilizer system.  
In this case, have the vehicle inspected by an authorized Kia dealer.

### Immobilizer indicator light (with smart key)

#### This indicator light appears for up to 30 seconds:

- When the vehicle detects the smart key in the vehicle properly while the ENGINE START/STOP button is ACC or ON.
  - At this time, you can start the engine.
  - The indicator light goes off after starting the engine.

#### This indicator light blinks for a few seconds:

- When the smart key is not in the vehicle.

- At this time, you can not start the engine.

**This indicator light appears for 2 seconds and goes off:**

- When the vehicle can not detect the smart key which is in the vehicle while the ENGINE START/STOP Button is ON.  
In this case, have the vehicle inspected by an authorized Kia dealer.

**This indicator light blinks:**

- When the battery of the smart key is weak.
  - At this time, you can not start the engine. However, you can start the engine if you press the ENGINE START/STOP Button with the smart key. (For more details, refer to "Immobilizer system" on page 5-11).
- When there is a malfunction with the immobilizer system.  
In this case, have the vehicle inspected by an authorized Kia dealer.

**Turn signal indicator light **

**This indicator light blinks:**

- When you turn the turn signal light on. If any of the following occurs, there may be a malfunction with the turn signal system. In this case, have the vehicle inspected by an authorized Kia dealer.
  - The indicator light does not blink but appears.
  - The indicator light blinks more rapidly.
  - The indicator light does not appear at all.

**Low beam indicator light **

**This indicator light appears:**

- When the headlamps are on.

**High beam indicator light **

**This indicator light appears:**

- When the headlamps are on and in the high beam position.
- When the turn signal lever is pulled into the Flash-to-Pass position.

**High Beam Assist indicator light**



**This indicator light appears:**

- When the high beam is on with the light switch in the AUTO light position.
- If your vehicle detects oncoming or preceding vehicles, High Beam Assist will switch the high beam to low beam automatically.

\* For more details, refer to "High Beam Assist (HBA)" on page 5-117.

**Light ON indicator light **

**This indicator light appears:**

- When the taillamps or headlamps are on.

**Front fog indicator light  (if equipped)**

**This indicator light appears:**

- When the front fog lights are on.

**Lane Safety indicator light** 

Lane Safety indicator will appear when you turn Lane Keeping Assist on by pressing Lane Safety button.

If there is a problem with Lane Keeping Assist, the yellow Lane Safety indicator will appear.

\* For more details, refer to "Lane Keeping Assist (LKA)" on page 6-80.

**Cruise Control indicator light**  **(if equipped)****This indicator light appears:**

- When the cruise control system is enabled.

\* For more details, refer to "Cruise Control (CC) (if equipped)" on page 6-115.

**Ready indicator** **This indicator illuminates:**

When the vehicle is ready to be driven.

- ON: Normal driving is possible.
- OFF: Normal driving is not possible, or a problem has occurred.

**EV mode indicator** **This indicator illuminates:**

When the vehicle is driven by the electric motor.

- "EV" indicator ON: Vehicle is driven using the electric motor or the gasoline engine is stopped.
- "EV" indicator OFF: Vehicle is driven using the gasoline engine.

**Charging cable connection indicator light**  **(Plug-in hybrid vehicle)**

This indicator illuminates in red when the charging cable is connected.

**SPORT Mode indicator light****This indicator light appears:**

- When you select "SPORT" mode as drive mode.

For more details, refer to "Drive mode integrated control system" on page 6-55.

**ECO Mode indicator light****This indicator light illuminates:**

- When you select "ECO" mode as drive mode.

For more details, refer to "Drive mode integrated control system" on page 6-55.

**Green zone drive mode indicator light** 

This indicator appears when you enter the inner road under as entering the inner road of a large hospital or school, registered favorites (Home/Office/favorite 1, 2, 3), large shopping mall and park (public, national, etc.).

Refer to "Green Zone Drive Mode" on page 6-56.

## Head-Up Display (HUD) (if equipped)

The Head-Up Display is a transparent display that projects an image of certain information from the instrument cluster and navigation system on the windshield glass.



- The head up display image on the HUD screen may be invisible when:
  - Sitting posture is bad.
  - Wearing a polarized sunglasses.
  - There is an object on the cover of the head up display.
  - Driving on a wet road.
  - An inadequate lighting is turned on inside the vehicle.
  - Any light comes from the outside.
  - Wearing an inadequate glasses to your eyesight.
- If the head up display image is not shown well, adjust the height, rotation or illumination of the head up display in the LCD display.
- When the head up display needs inspection or repair, Have the checked by an authorized Kia dealer.

### **WARNING**

#### Head-Up Display

- Do not make the front windshield glass have window tint or other types of metallic coating. Otherwise, the Head-Up Display image may be invisible.
- Do not place any accessories on the crash pad or attach any objects on the windshield glass.
- As Blind-Spot Collision-Avoidance Assist is a supplemental device for your safe driving, it may be dangerous to rely on only the Blind-Spot Safety information of the Head-Up Display image when changing the lane. Always pay attention to drive safely.

### **CAUTION**

When replacing the front windshield glass of the vehicles equipped with the Head-Up Display, replace it with a windshield glass designed for the Head-Up Display operation. Otherwise, duplicated images may be displayed on the windshield glass.

#### Head Up Display Information



- 1 Turn By Turn navigation information (if equipped)
- 2 Road signs
- 3 Speedometer

- 4 SCC set speed information (if equipped)
- 5 SCC vehicle distance information (if equipped)
- 6 Lane Following Assist information (if equipped)
- 7 Lane Safety information (if equipped)
- 8 Blind-Spot Safety information (if equipped)
- 9 Highway Driving Assist information (if equipped)
- 10 Highway Auto Speed Change information (if equipped)
- 11 Surrounding vehicle information

**\* NOTICE**

Road Signs and Turn By Turn navigation information are available depending on the region.

**Head-Up Display Setting**

On the LCD display, you can change the head up display settings as follows.

Type A	Type B
Enable Head-Up Display	Enable HUD
Display Height	Display Control •Height •Rotation •Brightness
Rotation	
Brightness	
Content Selection	Content Selection

\* For more details, refer to "User settings mode" on page 5-85.

**Lighting**

This vehicle is equipped with a variety of lights to appear the interior and exterior of the vehicle.

**⚠ CAUTION**

To prevent the battery from being discharged, do not leave the headlamp and interior light on for a prolonged time while the engine is not running.

**Battery saver function**

The purpose of this feature is to prevent the battery from being discharged if the lights are left in the ON position. The system automatically shuts off the parking lights after the engine is off and the driver's door is opened.

However, the position lamps stay ON even when the driver-side door is opened if the light switch is operated after the engine is turned off.

If necessary, to keep the lamps on turn the position lamps OFF and ON again using the headlamp switch on the steering column after the engine is turned off.

**Headlamp delay function**

If you place the ignition switch or ENGINE START/STOP button in the ACC or OFF position with the headlamps ON, the headlamps (and/or parking lights) remain on for about 5 minutes. However, with the engine off if the driver's door is opened and closed, the headlamps (and/or parking lights) are turned off after 15 seconds.

The headlamps (and/or parking lights) can be turned off by pressing the lock button on the key twice or turning the light switch to the OFF or AUTO position. However, if you turn the light switch to the AUTO position when it is dark out-

side, the headlamps will not be turned off.

You can activate or deactivate the Headlamp Delay function from the User Settings Mode in the LCD display. For more details, refer to "User settings mode" on page 5-85. If your vehicle is equipped with additional navigation, please refer to the user's manual provided in the infotainment system and the quick reference guide.

**\* NOTICE**

If the driver exits the vehicle through another door besides the driver door, the battery saver function does not operate and the headlamp delay function does not turn OFF automatically. This may cause the battery to discharge. To avoid battery discharge, turn OFF the headlamps manually from the headlamp switch before exiting the vehicle.

**Daytime Running Light (DRL)**

The Daytime Running Light (DRL) can make it easier for others to see the front of your vehicle during the day. The DRL can be helpful in many different driving conditions, and it is especially helpful after dawn and before sunset. The DRL will turn the dedicated lamp OFF when:

- The headlamps are ON.
- The vehicle is off.
- The front fog light is on. (if equipped)
- Engaging the parking brake.

**Lighting control**

The light switch has a headlamp and a position lamp position.



To operate the lights, turn the knob at the end of the control lever to one of the following positions:

- 1 OFF position
- 2 Auto light position
- 3 Position & Taillamp
- 4 Headlamp position

**Position & Taillamp**



When the light switch is in the position lamp position, the front position lamp, taillamp, and the license plate lamp will turn ON.

**Headlamp (Low Beam)**



When the light switch is in the headlamp position, headlamp (low beam), tail, license light will turn ON.

**\* NOTICE**

The ignition switch or ENGINE START/STOP button must be in the ON position to turn on the headlamps.

**Auto light**

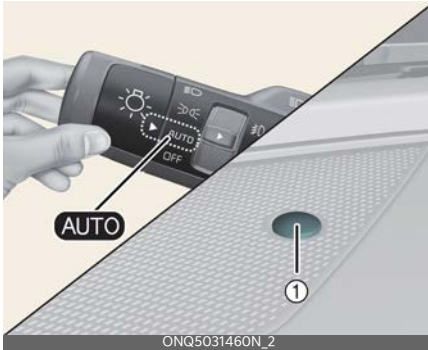

When the light switch is in the AUTO light position, the taillamps and headlamps will turn ON or OFF automatically depending on the amount of light outside the vehicle.

**⚠ CAUTION**

- Never place anything over the sensor (1) located on the instrument panel as this will ensure better auto-light system control.
- Don't clean the sensor using a window cleaner, the cleaner may leave a light film which could interfere with sensor operation.
- If your vehicle has window tint or other types of metallic coating on the front windshield, the Auto light system may not work properly.

**Operating high beam**



To turn on the high beam headlamp:

- Push the lever away from you.  
The lever will return to its original position.  
The high beam indicator will light when the headlamp high beams are switched on.

**⚠ WARNING**

**High beams**

Do not use high beam when there are other vehicles in front of or approaching your vehicle. Using high beam could obstruct the other driver's vision.

To flash the headlamps:

- Pull the lever towards you.



It will return to the normal (low beam) position when released. The headlamp switch does not need to be on to use this flashing feature.

## Operating turn signals and lane change signals



The ignition switch or ENGINE START/STOP button must be on for the turn signals to function.

To turn on the turn signals:

- Move the lever up or down (A).  
The green arrow indicators on the instrument panel indicate which turn signal is operating. They will self-cancel after a turn is completed. If the indicator continues to flash after a turn, manually return the lever to the OFF position.

To signal a lane change:

- Move the turn signal lever slightly and hold it in position (B).  
The lever will return to the OFF position when released.

If an indicator stays on and does not flash or if it flashes abnormally, one of the turn signal bulbs may be burned out and will require replacement.

### One-touch lane change function

To activate a one-touch lane change function, move the turn signal lever slightly and then release it. The lane change signals will blink 3, 5 or 7 times. You can activate or deactivate the One Touch Turn Signal function or choose the number of blinking (3, 5, or 7) by selecting "Vehicle → Lights → One Touch Turn Signal".

### \* NOTICE

If an indicator flash is abnormally quick or slow, a bulb may be burned out or have a poor electrical connection in the circuit. The bulb may require replacement.

### \* INFORMATION

The infotainment system may change after software updates. For more information, refer to the user's manual provided in the infotainment system and the quick reference guide.

### Operating front fog light $\neq$ (if equipped)

Fog lights are designed to provide improved visibility when visibility is poor due to fog, rain or snow, etc.



The fog lights will turn on when the fog light switch (1) is turned to the on position after the headlamp is turned on.

To turn off the fog lights:

- Turn the fog light switch (1) to the ON position.

### ⚠ CAUTION

When in operation, the fog lights consume large amounts of vehicle electrical power. Only use the fog lights when visibility is poor.



## High Beam Assist (HBA)



High Beam Assist is a function that automatically adjusts the headlamp range (switches between high beam and low beam) depending on the brightness of detected vehicles and certain road conditions.

## Detecting sensor

Front view camera



The front view camera is used as a detecting sensor to detect ambient light and brightness while driving.

Refer to the picture above for the detailed location of the detecting sensor.

### \* NOTICE

- Always keep the front view camera in good condition to maintain optimal performance of High Beam Assist.
- For more details on the precautions of the front view camera, refer to "Forward Collision-Avoidance Assist (FCA) (Front Camera Only) (if equipped)" on page 6-58 and "Forward Collision-Avoidance Assist (FCA) (Sensor Fusion) (if equipped)" on page 6-68.

## High Beam Assist setting

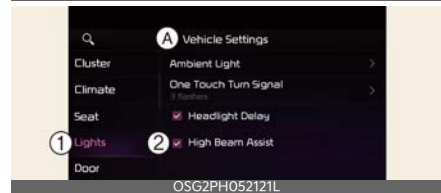
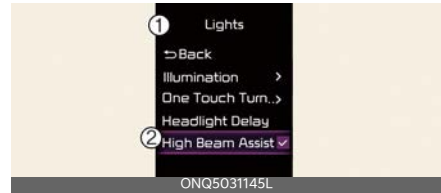

### A: Vehicle Settings

#### 1 Lights

#### 2 High Beam Assist

With the ignition switch or ENGINE START/STOP button in the ON position, select '**Lights** → **High Beam Assist**' from the Settings menu to turn on High Beam Assist and deselect to turn off the function.

### ⚠ WARNING

For your safety, adjust your high beam settings only after parking the vehicle at a safe location.

## High Beam Assist operation

### Display and control

- After selecting '**High Beam Assist**' in the Settings menu, High Beam Assist will operate by following the procedure below.
  - Place the headlamp switch in the AUTO position and push the headlamp lever towards the instrument cluster. The High Beam Assist  indicator light will appear on the

cluster and the function will be enabled.

- When the function is enabled, high beam will turn on when vehicle speed is above 40 km/h (25 mph). When vehicle speed is below 25 km/h (15 mph), high beam will not turn on.
- The High Beam (AUTO) indicator light will appear on the cluster when high beam is on.
- When High Beam Assist is operating, if the headlamp lever or switch is used, the function operates as follows:
  - If the headlamp lever is pulled towards you when the high beam is off, the high beam will turn on without High Beam Assist canceled. When you let go of the headlamp lever, High Beam Assist will turn on again.
  - If you push the light switch towards the instrument cluster, high beam is turned on and High Beam Assist is released.
  - If the headlamp lever is pulled towards you when the high beam is on by High Beam Assist, low beam will be on and the function will turn off.
  - If the headlamp switch is placed from AUTO to another position (headlamp/position/off), High Beam Assist will turn off and the corresponding lamp will turn on.
- When High Beam Assist is operating, high beam switches to low beam if any of the following conditions occur:
  - When the headlamp of an oncoming vehicle is detected.
  - When the taillamp of a vehicle in front is detected.

- When the headlamp or taillamp of a motorcycle or a bicycle is detected.
- When the surrounding ambient light is bright enough that high beams are not required.
- When streetlights or other lights are detected.

## Malfunction and limitations

### Malfunction

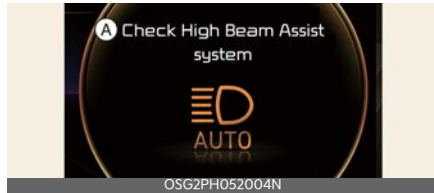

#### A: Check High Beam Assist system

When High Beam Assist is not working properly, the 'Check High Beam Assist (HBA) system' warning message will appear and warning light (⚠) will appear on the cluster. Have the function inspected by an authorized Kia dealer.

### Limitations

High Beam Assist may not work properly in the following situations:

- Light from a vehicle is not detected because of lamp damage, or because it is hidden from sight, etc.
- Headlamp of a vehicle is covered with dust, snow or water.
- A vehicle's headlamps are off but the fog lamps are on and etc.
- There is a lamp that has a similar shape as a vehicle's lamp.
- Headlamps have been damaged or not repaired properly.
- Headlamps are not aimed properly.
- Driving on a narrow curved road, rough road, uphill or downhill.

- Vehicle in front is partially visible on a crossroad or curved road.
- There is a traffic light, reflecting sign, flashing sign or mirror ahead.
- There is a temporary reflector or flash ahead (construction area).
- The road conditions are bad such as being wet, iced or covered with snow.
- A vehicle suddenly appears from a curve.
- The vehicle is tilted from a flat tire or is being towed.
- Light from a vehicle is not detected because of exhaust fume, smoke, fog, snow, etc.

**\* NOTICE**

- Depending on the instrument cluster specification or theme, images or colors may be displayed differently.
- For more details on the limitations of the front view camera, refer to "Forward Collision-Avoidance Assist (FCA) (Front Camera Only) (if equipped)" on page 6-58 and "Forward Collision-Avoidance Assist (FCA) (Sensor Fusion) (if equipped)" on page 6-68.

**\* NOTICE**

- At times, High Beam Assist may not work properly. The function is for your convenience only. It is the responsibility of the driver for safe driving practices and always check the road conditions for your safety.
- When High Beam Assist does not operate normally, change the head-lamp position manually between high beam and low beam.

**Wipers and washers**

The wipers and washers remove foreign substances from the windshield and rear window, helping to maintain visibility.

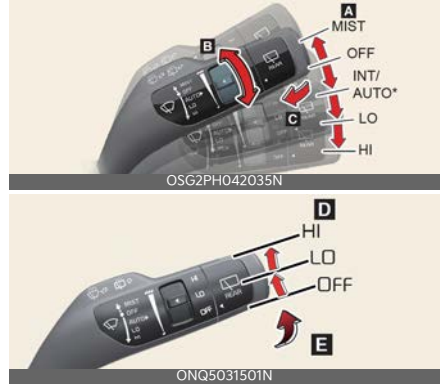

**A: Wiper speed control**

- MIST - Single wipe
- OFF - Off
- INT/ AUTO\*: Intermittent control wipe/ Auto control wipe
- LO - Low wiper speed
- HI - High wiper speed

**B: Auto control wipe time adjustment**

**C: Wash with brief wipes (Pull lever towards you)**

**D: Rear wiper/washer control**

- HI - Continuous wipe
- LO - Intermittent wipe
- OFF - Off

**E: Wash with brief wipes (Rear/Push lever away from you)**

\* : if equipped

**Windshield wipers**

Operate as follows when the ignition switch or ENGINE START/STOP button is ON.

- MIST: For a single wiping cycle, move the lever to this position and release it. The wipers will operate continuously if the lever is held in this position.
- OFF: Wiper is not in operation
- INT: Wiper operates intermittently at the same wiping intervals. Use this mode in light rain or mist. To vary the speed setting, turn the speed control knob.
- LO: Normal wiper speed
- HI: Fast wiper speed

**\* NOTICE**

If there is heavy accumulation of snow or ice on the windshield, defrost the windshield for about 10 minutes, or until the snow and/or ice is removed before using the windshield wipers to ensure proper operation. If you do not remove the snow and/or ice before using the wiper and washer, it may damage the wiper and washer system.

**⚠ WARNING**

Do not use the washer in freezing temperatures without first warming the windshield with the defrosters; the washer solution could freeze on the windshield and obscure your vision.

**Auto control (if equipped)**



The rain sensor (A) located on the upper end of the windshield glass senses the amount of rainfall and controls the wiping cycle for the proper interval. The

more it rains, the faster the wiper operates. When the rain stops, the wiper stops.

To vary the speed setting, turn the speed control knob (B).

If the wiper switch is set in AUTO mode when the ignition switch or ENGINE START/STOP button is ON, the wiper will operate once to perform a self-check of the system. Set the wiper to OFF position when the wiper is not in use.

**⚠ WARNING**

When the ignition switch or ENGINE START/STOP button is ON and the windshield wiper switch is placed in the AUTO mode, use caution in the following situations to avoid any injury to the hands or other parts of the body:

- Do not touch the upper end of the windshield glass facing the rain sensor.
- Do not wipe the upper end of the windshield glass with a damp or wet cloth.
- Do not put pressure on the windshield glass.

**⚠ CAUTION**

- When washing the vehicle, set the wiper switch in the OFF position to stop the auto wiper operation. The wiper may operate and be damaged if the switch is set in the AUTO mode while washing the vehicle.
- Do not remove the sensor cover located on the upper end of the passenger side windshield glass. Damage to system parts could occur and may not be covered by your vehicle warranty.

- When starting the vehicle in winter, set the wiper switch in the OFF position. Otherwise, wipers may operate and ice may damage the windshield wiper blades. Always remove all snow and ice and defrost the windshield properly prior to operating the windshield wipers.
- When tinting the windshield, be careful of any fluid getting into the sensor located in the top center of the front windshield. It may damage the related parts.

### Operating windshield washers



1. Move the wiper speed control switch to the OFF position.
2. Pull the lever gently toward you to spray washer fluid on the windshield and to run the wipers 1-3 cycles. Use this function when the windshield is dirty. The spray and wiper operation will continue until you release the lever.

If the washer does not work, check the washer fluid level. If the fluid level is not sufficient, you will need to add appropriate non-abrasive windshield washer fluid to the washer reservoir.

The reservoir filler neck is located in the front of the engine compartment on the passenger side.

### **CAUTION**

To prevent possible damage to the washer pump, do not operate the

washer when the fluid reservoir is empty.

### **WARNING**

Do not use the washer in freezing temperatures without first warming the windshield with the defrosters; the washer solution could freeze on the windshield and obscure your vision.

### **CAUTION**

- To prevent possible damage to the wipers or windshield, do not operate the wipers when the windshield is dry.
- To prevent damage to the wiper blades, do not use gasoline, kerosene, paint thinner, or other solvents on or near them.
- To prevent damage to the wiper arms and other components, do not attempt to move the wipers manually.
- To prevent possible damage to the wipers and washer system, use anti-freezing washer fluids in the winter season or cold weather.

### Operating rear window wiper and washer switch

The rear window wiper and washer switch is located at the end of the wiper and washer switch lever.

- Turn the switch to the desired position to operate the rear wiper and washer.



- HI - Normal wiper operation
- LO - Intermittent wiper operation

- OFF - Wiper is not in operation
- Push the lever away from you to spray rear washer fluid and to run the rear wipers several times.



The spray and wiper operation will continue until you release the lever.

When the front wiper is activated and the gear is switched to R (Reverse) position, the rear wiper will be activated once to provide better visibility.

## Welcome system (if equipped)

The welcome system is a function that illuminates the surroundings or the interior when the driver approaches or exits the vehicle.

## Door handle lamp (if equipped)



When all the doors (and liftgate) are closed and locked, the door handle lamp will come on for about 15 seconds if any of the below is performed.

- When the door unlock button is pressed on the smart key.
- When the button of the outside door handle is pressed.
- When the vehicle is approached with the smart key in possession.

## Headlamp (headlamp) escort function

The headlamps (and/or taillamps) remain on for approximately 5 minutes after the ignition key is removed or turned to the ACC or LOCK position. However, if the driver's door is opened and closed, the headlamps are turned off after 15 seconds.

The headlamps can be turned off by pressing the lock button on the transmitter or smart key twice or turning off the light switch from the headlamp or Auto light position.

## Interior light

When the interior light switch is in the DOOR position and all doors (and lift-gate) are locked and closed, the room lamp will come on for 30 seconds if any of the following occurs:

- With the smart key system
  - When the door unlock button is pressed on the smart key.
  - When the button of the outside door handle is pressed.

At this time, if you press the door lock button, the lamps will turn off immediately.

## Interior lights

This vehicle is equipped with lights throughout the vehicle to illuminate the interior.

### ⚠ CAUTION

Do not use the interior lights for extended periods when the engine is not running.

It may cause battery discharge.

### ⚠ WARNING

Do not use the interior lights when driving in the dark. Accidents could happen because the view may be obscured by interior lights.

## Automatic turn off function

The interior lights automatically turn off approximately 20 minutes after the ENGINE START/STOP button is turned off, if the lights are in the ON position.

If your vehicle is equipped with the theft alarm system, the interior lights automatically turn off approximately 5 seconds after the system is armed.

## Map lamp

Type A



## Type B



- Press the lens (1) to turn ON the map lamp.  
To turn the map lamp OFF press the lens (1) again.
-  (2): DOOR mode
  - The map lamp and room lamp come on when a door is opened. The lamps go out after approximately 30 seconds.
  - The map lamp and room lamp come on for approximately 30 seconds when doors are unlocked with a smart key as long as the doors are not opened.
  - The map lamp and room lamp will stay on for approximately 20 minutes if a door is opened with the ENGINE START/STOP button in the ACC or OFF position.
  - The map lamp and room lamp will stay on continuously if the door is opened with the ENGINE START/STOP button in the ON position.
  - The map lamp and room lamp will go out immediately if the ENGINE START/STOP button is changed to the ON position or all doors are locked.
  - To turn off the DOOR mode, press the DOOR button (2) once again (not pressed).

-  (3): Press this switch to turn the front and rear room lamps on and off.

## \* NOTICE



The DOOR mode and ROOM mode can not be selected at a time.

## Room lamp (if equipped)



Press the switch to turn the room lamp on and off.

## Luggage room lamp

-  : The lamp will always turn on when the liftgate is opened/closed.
-  : The lamp is on when the liftgate is opened, and off when the liftgate is closed.
-  : The lamp will always turn off when the liftgate is opened/closed.



The luggage room lamp comes on when the liftgate is opened.

## ⚠ CAUTION

The luggage room lamp comes on as long as the liftgate opens. To prevent unnecessary charging system drain, close the liftgate securely after using the luggage room.



## Vanity mirror lamp (if equipped)



Push the switch to turn the light on or off.

- : The lamp will turn on if this button is pressed.
- : The lamp will turn off if this button is pressed.

### CAUTION

#### Vanity mirror lamp

Always close the lid of the vanity mirror in the off position when the vanity mirror lamp is not in use. If the sun visor is closed without the lamp off, it may discharge the battery or damage the sun visor.

## Glove box lamp



The glove box lamp comes on when the glove box is opened.

### \* NOTICE

To prevent unnecessary charging system drain, close the glove box securely after using the glove box.

## Climate control system

The climate control system uses cooling and heating to help maintain a pleasant environment inside the vehicle.

### System operation

#### Ventilation

1. Set the mode to the position.
2. Set the air intake control to the outside (fresh) air position.
3. Set the temperature control to the desired position.
4. Set the fan speed control to the desired speed.

#### Heating

1. Set the mode to the position.
2. Set the air intake control to the outside (fresh) air position.
3. Set the temperature control to the desired position.
4. Set the fan speed control to the desired speed.
5. If dehumidified heating is desired, turn the air conditioning system on.
  - If the windshield fogs up, set the mode to the or position.

#### Operation tips

- To keep dust or unpleasant fumes from entering the vehicle through the ventilation system, temporarily set the air intake control to the recirculated air position. Be sure to return the control to the fresh air position when the irritation has passed to keep fresh air in the vehicle. This will help keep the driver alert and comfortable.

- Air for the heating/cooling system is drawn in through the grilles just at the base of the windshield. Care should be taken that these are not blocked by leaves, snow, ice or other obstructions.
- To prevent fog from forming on the inside of the windshield:
  - Set the air intake control to the fresh air position and the fan speed to the desired position.
  - Turn on the air conditioning system, and adjust the temperature control to desired temperature.

## Air conditioning (A/C)

All Kia air conditioning systems are filled with R-1234yf refrigerant.

1. Start the vehicle. Press the A/C button.
2. Set the mode to the  position.
3. Set the air intake control to the outside-air or recirculated air position.
4. Adjust the fan speed control and temperature control to maintain maximum comfort.

### ⚠ CAUTION

- The refrigerant system should only be serviced by trained and certified technicians to insure proper and safe operation.
- The refrigerant system should be serviced in a well-ventilated place.
- The air conditioning evaporator (cooling coil) shall never be repaired or replaced with one removed from a used or salvaged vehicle and new replacement MAC evaporators shall be certified (and labeled) as meeting SAE Standard J2842.

### ⚠ CAUTION

#### Excessive air conditioning use

When using the air conditioning system, monitor the temperature gauge closely while driving up hills or in heavy traffic when outside temperatures are high. Air conditioning system operation may cause vehicle overheating. Continue to use the blower fan but turn the air conditioning system off if the temperature gauge indicates vehicle overheating.

### ⚠ CAUTION

The air conditioning system should only be used with the windows and sunroof closed to prevent condensation inside the vehicle that may cause damage to electrical components.

## Air conditioning system operation tips

- If the vehicle has been parked in direct sunlight during hot weather, open the windows for a short time to let the hot air inside the vehicle escape.
- To help reduce moisture inside of the windows on rainy or humid days, decrease the humidity inside the vehicle by operating the air conditioning system.
- During air conditioning system operation, you may occasionally notice a slight change in vehicle speed as the air conditioning compressor cycles. This is a normal characteristic of system operation.
- To ensure maximum system performance, the air conditioning system should be run for a few minutes each month.

- When using the air conditioning system, you may notice clear water dripping (or even puddling) on the ground under the passenger side of the vehicle. This is a normal characteristic of system operation.
- Operating the air conditioning system in the recirculated air position provides maximum cooling; however, continual operation in this mode may cause the air inside the vehicle to become stale.
- During cooling operation, you may occasionally notice a misty air flow because of rapid cooling and humid air intake. This is a normal characteristic of system operation.

**Climate control air filter**

The climate control air filter installed behind the glove box filters the dust or other pollutants that come into the vehicle from the outside through the heating and air conditioning system.

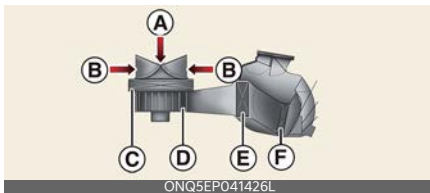

- A: Outside air
- B: Recirculated air
- C: Climate control air filter
- D: Blower
- E: Evaporator core
- F: Heater core

If dust or other pollutants accumulate in the filter over a period of time, the air flow from the air vents may decrease. This leads to moisture accumulating on the inside of the windshield even when the outside (fresh) air position is

selected. If this happens, have the climate control air filter replaced by an authorized Kia dealer.

**\* NOTICE**

- Replace the filter according to the Maintenance Schedule. If the vehicle is being driven in severe conditions such as dusty or rough roads, more frequent air conditioner filter inspections and changes are required.
- When the air flow rate suddenly decreases, have the system checked by an authorized Kia dealer.

**Checking the amount of air conditioner refrigerant and compressor lubricant**

When the amount of refrigerant is low, the performance of the air conditioning is reduced. Overfilling also has a negative impact on the air conditioning system.

Therefore, if abnormal operation is found, have the system inspected by an authorized Kia dealer.

**⚠ WARNING**

The oil and refrigerant in your vehicle's air conditioning system is under very high pressure. If proper service procedures are not followed, an explosion may result. To reduce the risk of serious injury or death, the air conditioning system in your vehicle should only be serviced by trained and certified technicians.

**⚠ CAUTION**

It is important that the correct type and amount of oil and refrigerant is used, otherwise damage to the vehicle may occur. To prevent damage, the air condi-

tioning system in your vehicle should only be serviced by trained and certified technicians.

---

**⚠ WARNING**

**Vehicles equipped with R-1234yf**



Since the refrigerant is mildly flammable and operated at high pressure, the air conditioning system should only be serviced by trained and certified technicians.

It is important that the correct type and amount of oil and refrigerant are used. All refrigerants should be reclaimed with proper equipment. Venting refrigerants directly to the atmosphere is harmful to individuals and environment. Failure to heed these warnings can lead to serious injuries.



## Automatic climate control system

The automatic climate control system uses cooling and heating to help maintain a pleasant environment inside the vehicle.

Type A

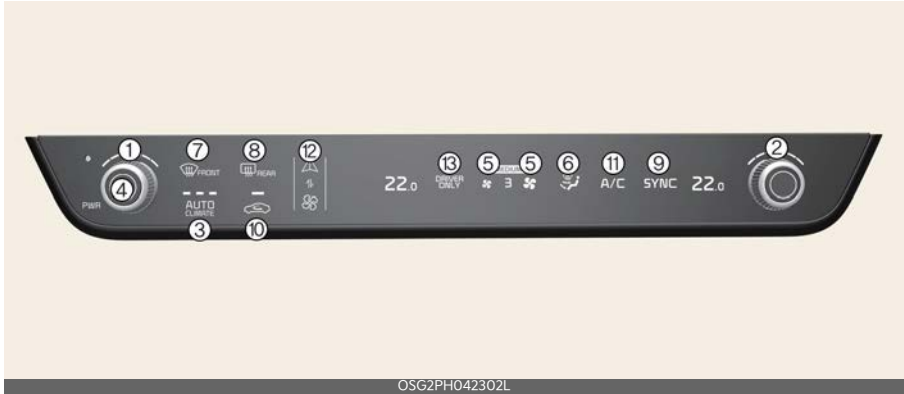

Type B (control panel)



- 1 Driver's temperature control knob
- 2 Passenger's temperature control knob
- 3 AUTO (automatic control) button
- 4 OFF button
- 5 Fan speed control button
- 6 Mode selection button
- 7 Front windshield defroster button
- 8 Rear window defroster button
- 9 SYNC button

- 10** Air intake/outtake control button
- 11** Air conditioning (A/C) button
- 12** Infotainment/climate control mode switching button
- 13** Driver's side only button
- 14** Front glass heater (if equipped)

**\* NOTICE**

Operating the blower when the ignition switch is in the ON position could cause the battery to discharge. Operate the blower when the engine is running.

**Using the infotainment/climate switchable controller control panel (For Type B)**

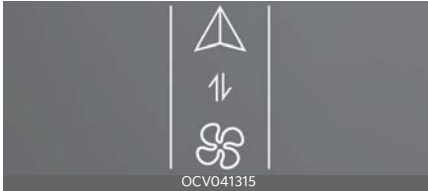

Press the button on the switchable controller to switch between infotainment system or climate control panel.

Press and hold the button to select the default mode for the control panel.

**Switching between panels**

Infotainment control panel



Type A



Type B



Press the button on the switchable controller to select the desired control panel. The selected control panel icon will appear and the control panel will be changed.

- The knob display will appear according to the selected control panel mode.
- When the vehicle is in the ACC position, only the infotainment system will be activated.

**Setting the default mode**



Press and hold the button to select the default mode for the control panel.

- After the setting, the control panel will return to the default mode after a certain period of time even if the control panel is switched to the different mode.
- If the mode is set to 'OFF', the control panel will display the mode used recently.

## Heating and air conditioning automatically

1. Press the AUTO button.

The modes, fan speeds, air intake and air-conditioning will be controlled automatically by setting the temperature.



You can control the air flow in three stages by pushing the AUTO button during automatic operation.

Level	Indicator	LCD Display	Air flow
High			2~8
Medium			1~6
Low			1~4

- **HIGH:** Provide rapid air conditioning and heating with strong air flow
- **MEDIUM:** Provide air conditioning and heating with medium strength air flow.
- **LOW:** It is suitable for drivers who prefer to soft air flow. When you select the temperature to HI or LO in AUTO mode, the air flow strength is automatically set to 'HIGH'.

2. Set the temperature control switch to the desired temperature.



The climate control system is automatically controlled according to the desired temperature.

- To turn the automatic operation off, select any of the following buttons or switches:

- Mode selection button
- Air conditioning (A/C) button
- Front air flowshield defroster button (Press the button one more time to deselect the front windshield defroster function. The 'AUTO' sign will appear on the information display once again.)
- Fan speed control switch

The selected function will be controlled manually while other functions operate automatically.

- For your convenience and to improve the effectiveness of the climate control, use the AUTO button and set the temperature to 22 °C (72 °F).

### \* NOTICE

Do not place anything over the sensor located on the instrument panel to ensure better control of the heating and cooling system.

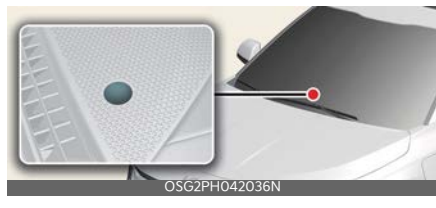





## Heating and air conditioning manually

The heating and cooling system can be controlled manually by pressing buttons other than the AUTO button.



In this case, the system works sequentially according to the order of buttons selected.

1. Start the vehicle.
2. Set the mode to the desired position.
  - For improving the effectiveness of heating and cooling;
    - Heating: 
    - Cooling: 
3. Set the temperature control to the desired position.
4. Set the air intake control to the outside (fresh) air position.
5. Set the fan speed control to the desired speed.

If air conditioning is desired, turn the air conditioning system on.

Press the AUTO button in order to convert to fully automatic control of the system.

### Mode selection

The mode selection button controls the direction of the air flow through the ventilation system.

Type A



Type B



The air flow outlet ports are switched in the following sequence:



#### Face-Level (B, D, F)

Air flow is directed toward the upper body and face. Additionally, each outlet can be controlled to direct the air discharged from the outlet.

#### Bi-Level (B, C, D, E, F)

Air flow is directed towards the face and the floor.

#### Floor-Level (A, C, D, E, F)

Most of the air flow is directed to the floor, with a small amount of the air being directed to the windshield, side window defrosters and side air vents.

#### Floor/Defrost-Level (A, C, D, E, F)

Most of the air flow is directed to the floor and the windshield with a small amount directed to the side window defrosters and side air vents.

#### Defrost-Level (A, D)

Most of the air flow is directed to the windshield with a small amount of air directed to the side window defrosters and side air vents.

### Controlling the vents

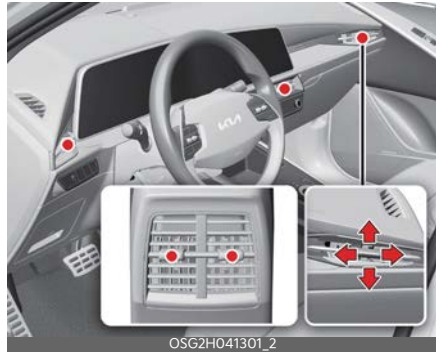

You can adjust the direction of air delivery from these vents using the vent control lever as shown.

To close the vent, push the air vent lever in the opposite direction of the passenger.

To open the vent, push the air vent lever in the same direction of the passenger.

### Temperature control



The temperature will increase to the maximum (HI) by turning the knob all the way to the right.

The temperature will decrease to the minimum (Lo) by turning the knob all the way to the left.

When turning the knob, the temperature will increase or decrease by 0.5 °C/1 °F. When set to the lowest temperature setting, the air conditioning will operate continuously.

**\* NOTICE**

When starting the vehicle in cold weather using manual temperature control, operate the system in the following method to improve heating.

- Turn off or lower the blower, right after starting the engine.
- Allow the engine to warm up during this time since the air flow from the heater is still cold.
- After a few minutes of engine warm up, turn on or set the fan to a higher level and adjust the temperature setting to hot.

**Adjusting the driver and passenger side temperature equally**

Type A



Type B



1. Press the "SYNC" button to adjust the driver and passenger side temperature equally.

The passenger side temperature will be set to the same temperature as the driver side temperature.

2. Turn the driver side temperature control knob. The driver and passenger side temperature will be adjusted equally.
3. If you rotate the passenger's temperature control knob, the SYNC button is turned off and the passenger side temperature can be operated individually.

**Adjusting the driver and passenger side temperature individually**

Press the "SYNC" button again to adjust the driver and passenger side temperature individually. The button indicator will turn off.

**Changing temperature scale**

- To change the temperature display from Fahrenheit to Celsius and vice versa, press the OFF button, while pressing the AUTO button for 3 seconds or more.

The display will change from Centigrade to Fahrenheit, or from Fahrenheit to Centigrade. If the battery has been discharged or disconnected, the temperature mode display will reset to Fahrenheit.

**Controlling air intake**

This is used to select the outside (fresh) air position or recirculated air position.



To change the air intake control position:

- Push the desired control button.

### Outside (fresh) air position



With the outside (fresh) air position selected, air enters the vehicle from outside and is heated or cooled according to the function selected.

### Recirculated air position



With the recirculated air position selected, air from the passenger compartment will be drawn through the heating system and heated or cooled according to the function selected.

Prolonged operation of the heater in the recirculated air position (without air conditioning selected) may cause fogging of the windshield and side windows and make the air in the passenger compartment stale.

In addition, prolonged use of the air conditioning with the recirculated air position selected will result in excessively dry air in the passenger compartment.

#### \* NOTICE

Prolonged operation of the heater in the recirculated air position (without air conditioning selected) may cause fogging of the windshield and side windows and the air within the passenger compartment may become stale.

In addition, prolonged use of the air conditioning with the recirculated air posi-

tion selected will result in excessively dry air in the passenger compartment.

#### WARNING

Continued climate control system operation in the recirculated air position may allow humidity to increase inside the vehicle which may fog the glass and obscure visibility.

### Controlling fan speed

The fan speed can be set to the desired speed by operating the fan speed control button.

To change the fan speed:

- Press button right for higher speed, or press button left for lower speed.



To turn the fan speed control off:

- Press the front blower OFF button.

### Air conditioning (A/C)



- Press the A/C button to turn the air conditioning system on (indicator light will appear).
- Press the button again to turn the air conditioning system off.

#### WARNING

#### Reduced Visibility

Continuous use of the climate control system in the recirculated air position may allow humidity to increase inside

the vehicle, which may fog the glass and obscure visibility.

### **⚠ WARNING**

#### **Recirculated Air**

Continued use of the climate control system in the recirculated air position can cause drowsiness or sleepiness, and loss of vehicle control. Set the air intake control to the outside (fresh) air position as much as possible while driving.

### **⚠ WARNING**

#### **Sleeping with A/C on**

Do not sleep in a vehicle with the air conditioning or heating on as this may cause serious harm or death due to a drop in the oxygen level and/or body temperature.

#### **Turning off the front air climate control**



- Press the OFF button to turn off the front and rear air climate control system.



However, you can still operate the mode and air intake buttons as long as the ignition switch or ENGINE START/STOP button is in the ON position.

#### **Windshield defrosting and defogging**

When the windshield is covered with frost or moisture, the front view is blurred, you should remove the frost and moisture.

### **⚠ WARNING**

#### **Windshield heating**

Do not use the  or  position during cooling operation in extremely humid weather. The difference between the temperature of the outside air and the windshield could cause the outer surface of the windshield to fog up, causing loss of visibility. In this case, set the mode selection to the  position and fan speed control to the lower speed.

- For maximum defrosting, set the temperature control to the extreme right/hot position and the fan speed control to the highest speed.
- If warm air to the floor is desired while defrosting or defogging, set the mode to the floor-defrost position.
- Before driving, clear all snow and ice from the windshield, rear window, outside rear view mirrors, and all side windows.
- Clear all snow and ice from the hood and air inlet in the cowl grill to improve heater and defroster efficiency and to reduce the probability of fogging up the inside of the windshield.

### Defogging inside windshield

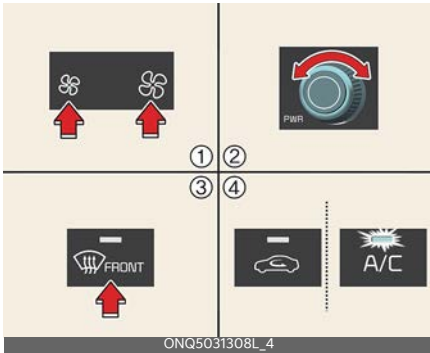

1. Set the fan speed to the desired position.
2. Select desired temperature.
3. Press the defroster button (  ).
4. The outside (fresh) air position will be selected automatically and the air conditioning will turn on according to the detected ambient temperature.

If the air conditioning and outside (fresh) air position are not selected automatically, adjust the corresponding button manually. If the  position is selected, lower fan speed is adjusted to a higher fan speed.

### Defrosting outside windshield

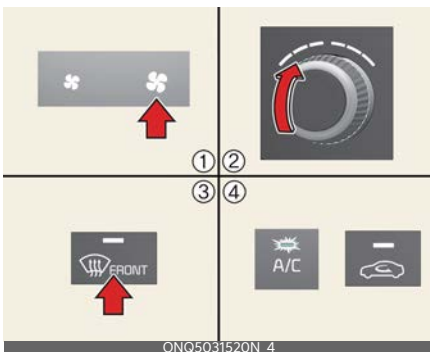

1. Set the fan speed to the highest position.
2. Set the temperature to the extreme hot (HI) position.
3. Press the defroster button (  ).
4. The outside (fresh) air position will be selected automatically and the air conditioning will turn on according to the detected ambient temperature.

### Auto defogging system

Auto defogging helps reduce the possibility of fogging up the inside of the windshield by automatically sensing the moisture on inside the windshield.



 **AUTO** The auto defogging system operates when the heater or air conditioning is on.

When the Auto Defogging System operates, the indicator will appear.

If a high amount of humidity is detected in the vehicle, the Auto Defogging System will be enabled.

The following steps will be performed automatically:

1. The A/C button will turn ON.
2. The air intake control will change to Fresh mode under low outside temperature.
3. The mode will be changed to defrost to direct airflow to the windshield.
4. The fan speed will be increased.

To cancel or reset the Auto Defogging System

Press the front windshield defroster button for 3 seconds when the ignition switch or ENGINE START/STOP button is in the ON position.

When the Auto Defogging System is canceled, defrost button indicator will blink 3 times.

When the Auto Defogging System is reset, defrost button indicator will blink 6 times without a signal.

### \* NOTICE

- When the air conditioning is turned on by Auto defogging system, if you try to turn off the air conditioning, the indicator will blink 3 times and the air conditioning will not be turned off.
- To maintain the effectiveness and efficiency of the Auto Defogging System, do not select Recirculation mode while the system is operating.
- When the Auto Defogging System is operating, the fan speed adjustment knob, the temperature adjustment knob, and the air intake control button are all disabled.

### \* NOTICE

Do not remove the sensor cover located on the upper end of the driver side windshield glass.

Damage to system parts could occur and may not be covered by your vehicle warranty.

## Defroster

The vehicle is equipped with a defroster for removing frost or fog from the rear window.

### ⚠ CAUTION

#### Conductors

To prevent damage to the conductors bonded to the inside surface of the rear window, never use sharp instruments or window cleaners containing abrasives to clean the window.

If you want to defrost and defog the front windshield, refer to "Windshield defrosting and defogging" on page 5-137.

## Operating rear window defroster

The defroster heats the window to remove frost, fog and thin ice from the rear window, while the engine is on.

If there is heavy accumulation of snow on the rear window, brush it off before operating the rear defroster.



To activate the rear window defroster:

- Press the rear window defroster button located in the heater control panel.

The indicator on the rear window defroster button illuminates when the defroster is ON.

The rear window defroster automatically turns off after approximately 20 minutes or when the ENGINE START/STOP button is turned off.



To turn off the defroster:

- Press the rear window defroster button again.

### Outside mirror defroster (if equipped)

If your vehicle is equipped with the outside mirror defrosters, they will operate at the same time you turn on the rear window defroster.

### Defogging logic (if equipped)

To reduce the possibility of fogging up the inside of the windshield, the air intake or air conditioning is controlled automatically according to certain conditions such as  or  position.

To cancel automatic defogging logic or return to the automatic defogging logic, do the following.

### Canceling/returning automatic defogging logic

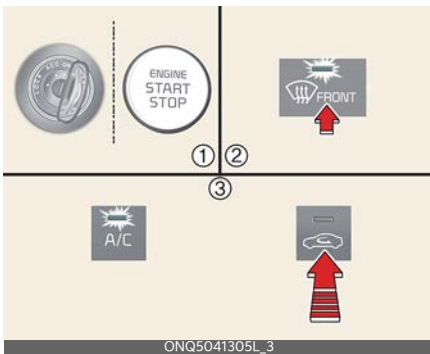

1. Turn the vehicle to the ON position.
2. Press the defroster button (.
3. While pressing the air conditioning (A/C) button, press the air intake control button at least 5 times within 3 seconds.

The recirculation indicator blinks 3 times in 0.5 second of intervals. It indi-

cates that the defogging logic is canceled or returned to the programmed status.

If the battery has been discharged or disconnected, it resets to the defog logic status.

### Canceling/returning automatic defogging logic

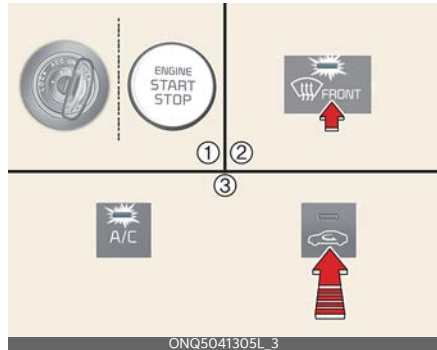

1. Turn the vehicle to the ON position.
2. Press the defroster button (.
3. While pressing the air conditioning (A/C) button, press the air intake control button at least 5 times within 3 seconds.

The recirculation indicator blinks 3 times in 0.5 second of intervals. It indicates that the defogging logic is canceled or returned to the programmed status.

If the battery has been discharged or disconnected, it resets to the defog logic status.



## Front glass heater (if equipped)

The front glass heater heats the window to remove frost, fog and thin ice from the interior and exterior of the front window, while the engine is running.



ONQ5031373L

If there is heavy accumulation of snow on the front window, brush it off before operating the front glass heater.



ONQ5031350L

To activate the front glass heater:

- Press the front glass heater button. The indicator on the front glass heater button illuminates when the front glass heater is ON.

The front glass heater automatically turns off after approximately 15 minutes or when the ignition switch or ENGINE START/STOP button is turned off. However, if you press the button again after the heater is turned off automatically after 15 minutes, the heater will stay on only for approximately 5 minutes. To turn off the front glass heater while it is operating, press the front glass heater button again.

## Storage compartment

These compartments can be used to store small items required by the driver or passengers.

- To avoid possible theft, do not leave valuables in the storage compartment.
- Always keep the storage compartment covers closed while driving. Do not attempt to place so many items in the storage compartment that the storage compartment cover cannot close securely.

### **⚠ WARNING**

#### Flammable materials

Do not store glasses, gas lighter, portable battery, canned beverage, spray can, propane cylinder, cosmetic tube or other flammable/explosive materials in the vehicle. These items may catch fire and/or explode if the vehicle is exposed to hot temperatures for extended periods.

#### Center console storage



OSG2PH042043N

To open the center console storage:

- Pull up the lever.

## Glove box



To open the glove box:

- Push the lever and the glove box will automatically open.

Close the glove box after use.

### **⚠ WARNING**

#### Glove box

To reduce the risk of injury in an accident or sudden stop, always keep the glove box door closed while driving.

An open glove box door can cause serious injury to the passenger in an accident, even if the passenger is wearing a seat belt.

### **⚠ CAUTION**

Do not keep food in the glove box for a long time.

### **\* NOTICE**

If the temperature control switch is in the warm or hot position, warm or hot air will flow into the glove box.

## Interior features

There are various features inside the vehicle for the convenience of the occupants.

### Ambient lights (if equipped)



The ambient lights are applied to the front crash pad and the center console.

When the headlamp light is on, the ambient light is on at the same time could be set in the infotainment menu.

### **\* INFORMATION**

The infotainment system may change after software updates. For more information, refer to the user's manual provided in the infotainment system and the quick reference guide.

### Cup holder (if equipped)



Cups or small beverage cans may be placed in the cup holders.

**⚠ WARNING**

**Hot liquids**

Do not place uncovered cups with hot liquid in the cup holder while the vehicle is in motion. If the hot liquid spills, you may burn yourself. Such a burn to the driver could lead to loss of control of the vehicle.

**⚠ WARNING**

Keep cans or bottles out of direct sun light and do not put them in a vehicle that is heated up. It may explode.

**⚠ CAUTION**

- Keep your drinks sealed while driving to prevent spilling your drink. If liquid spills, it may get into the vehicle's electrical/electronic system and damage electrical/electronic parts.
- When cleaning spilled liquids, do not use heat to dry the cup holders. This may damage the cup holder.

**Seat warmer (if equipped)**

The seat warmer is provided to warm the front seats during cold weather.



With the ignition switch or ENGINE START/STOP button in the ON position:

- Push either of the buttons to warm the front and rear seats.

During mild weather or under conditions where the operation of the seat warmer is not needed, keep the buttons in the "OFF" position.

The seat warmer defaults to the OFF position whenever the ignition switch or ENGINE START/STOP button is turned on.

**Temperature control (Manual)**

- Each time you press the buttons, the temperature setting of the seat will change as follows:
  - Front seat

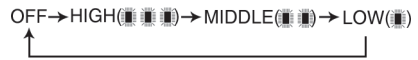

- Rear seat



**Temperature control (Automatic)**

The seat warmer starts to automatically control the seat temperature in order to prevent low-temperature burns after being manually turned ON.



\* Rear seats have no middle level.

You may manually press the button to increase the seat temperature. However, it soon returns to the automatic mode again.

- When pressing the buttons for more than 1.5 seconds with the seat warmer operating, the seat warmer will turn OFF.

**\* NOTICE**

With the seat warmer buttons in the ON position, the heating system in the seat turns off or on automatically depending on the seat temperature.

**⚠ CAUTION**

- When cleaning the seats, do not use an organic solvent such as paint thinner, benzene, alcohol and gasoline. Doing so may damage the surface of the heater or seats.
- To prevent overheating the seat warmer, do not place anything on the seats that insulates against heat, such as blankets, cushions or seat covers while the seat warmer is in operation.
- Do not place heavy or sharp objects on seats equipped with seat warmers. Damage to the seat warming components could occur.
- Do not change the seat cover. It may damage the seat warmer or air ventilation system.

**⚠ WARNING**

**Seat warmer burns**

Passengers should use extreme caution when using seat warmers due to the possibility of excess heating or burns. The seat warmer may cause burns even at low temperatures, especially if used for long periods of time. In particular, the driver must exercise extreme care for the following types of passengers:

1. Infants, children, elderly or handi-capped persons, or hospital outpatients
2. Persons with sensitive skin, those unable to detect heat or pain in parts of the body that are next to the heaters, or those that burn easily
3. Fatigued individuals
4. Intoxicated individuals
5. Individuals taking medication that can cause drowsiness or sleepiness (sleeping pills, cold tablets, etc.)

**Air ventilation seat (if equipped)**



The temperature setting of the seat changes according to the buttons position.

- To ventilate front seats cushion, push the buttons.

Each time you push the buttons, the airflow will change as follows:

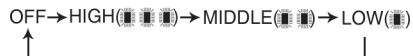

The seat warmer (with air ventilation) defaults to the OFF position whenever the ENGINE START/STOP button is turned on.

**⚠ CAUTION**

**Seat damage**

- When cleaning the seats, do not use an organic solvent such as paint thinner, benzene, alcohol and gasoline.

Doing so may damage the air ventilation seat.

- Do not place heavy or sharp objects on the seat. Those things may damage the air ventilation seat.
- Be careful not to spill liquid such as water or beverages on the seat. If you spill some liquid, wipe the seat with a dry towel. Before using the air ventilation seat, dry the seat completely.

### Sun visor

Use the sun visor to shield direct light through the front or side windows.



The actual sun visor lamp in the vehicle may differ from the illustration.

- To use the sun visor, pull it downward.
- To use the sun visor for the side window, pull it downward, unsnap it from the bracket (1) and swing it to the side (2).
- To use the vanity mirror, pull down the visor and slide the mirror cover (4). Adjust the sun visor extension forward or backward (3) (if equipped). The ticket holder (5) is provided for holding a tollgate ticket.

### **⚠ WARNING**

For your safety, do not block your view when using the sun visor.

### **\* NOTICE**

Do not put several tickets in the ticket holder at one time. This could cause damage to the ticket holder.

### USB charger

The USB car charger allows drivers to charge their digital devices such as smart phones, and PC tablets.

Front



Plug the cable into the USB port, and charging will begin.

The USB car charger is available with either the ACC on or the ignition on. We recommend you connect the USB port and digital devices with the engine running. See the display screen of the device to check its charging process completion. Your smart phone or table PC could get heated up while charging. This is no reason to worry, as it doesn't impact life or functions of the device. For safety, charging can be stopped if the battery gets too high where the temperature can negatively affect the device. Charging some digital devices is not available or requires special dedicated adapters if their charging methods don't fit the way the USB car charger works.

Power Delivery 3.0 is available on the smart phone or the tablet equipped with fast charging capabilities. It is applicable to digital devices with USB C-type.

Charging speed is determined according to the charging specification of the connected digital device.

Rated output:

- Digital device with fast charging:
  - 9.0V / Max 3.0A
- Digital devices with normal charging:
  - 5.0V / Max 3.0A

### **⚠ CAUTION**

- Use the USB car charger with the ignition on. Otherwise, Vehicle battery can be discharged.
- Use the official USB cable of the manufacturer of the digital device to be charged.
- Make sure that any foreign object, drinks, and water do not come into contact with the USB car charger. Water or foreign object can damage the USB charger.
- Do not use devices that exceed current consumption of 2.1 A.
- Do not connect an electrical device that generates excessive electromagnetic noise to the USB car port. If you do so, noise can be caused or vehicle electronic devices can be interrupted while audio or AV is on.
- If the charger is connected incorrectly, it can cause serious damage to the device. Please note that damages due to incorrect usage are not covered by warranty service.

## AC inverter (if equipped)



The AC inverter supplies 115V/150W electric power to operate electric accessories or equipment. If you wish to use the AC inverter, open up the AC inverter cover and connect a plug to it. The AC inverter supplies electric power when engine is running.

### **\* NOTICE**

- Rated voltage: AC 115V
- Maximum electric power: 150W
- In order to avoid an electrical system failure, electric shock, etc., be sure to read owner's manual before use.
- Be sure to close the cover except for when in use.
- To prevent the battery from being discharged, do not use the AC inverter while the engine is not running.
- After using an electric accessory or equipment, pull the plug out. Leaving the accessory or equipment plugged in for a long time may cause battery discharge.
- Do not use an electric accessory or equipment the power consumption of which is greater than 150W (115V).
- When the AC inverter input voltage is less than 11.3V, automatically turn off the power. AC inverter will operate as normal when the voltage is increased.
- When the AC inverter input voltage is less than 10.7V, power will turn off. The AC inverter will operate as normal when the voltage is increased.

- While the power consumption of some electrical devices/appliances may be within the AC inverter's electric power range, it may malfunction in below cases.
  - If the device/appliance requires high electric power for initial start up
  - If the device/appliance processes precise/very accurate data
  - If the device/appliance requires very stable supply of electricity

**⚠ CAUTION**

**Electric accessory devices**

- Do not use broken electric accessories which may damage the AC inverter and electrical systems of the vehicle.
- Do not use two or more electric accessories at the same time. It may cause damage to the electrical systems of the vehicle.

**Power outlet**

The power outlet is designed to provide power for mobile telephones or other devices designed to operate with vehicle electrical systems or other devices that are compatible with the power outlet and vehicle electrical system.



The devices should draw less than 15 amps with the vehicle on.

**\* NOTICE**

- Use the power outlet only when the vehicle is on and remove the acces-

sory plug after use. Using the accessory plug for prolonged periods of time with the vehicle off could cause the battery to discharge.

- Only use 12 V electric accessories which are less than 15 A in electric capacity.
- Adjust the air-conditioner or heater to the lowest operating level when using the power outlet.
- Close the cover when not in use.
- Some electronic devices can cause electronic interference when plugged into a vehicle's power outlet. These devices may cause excessive audio static and malfunctions in other electronic systems or devices used in your vehicle.
- Push the plug in as far as it will go. If good contact is not made, the plug may overheat and the fuse may open.
- Plug in battery equipped electronic devices with reverse current protection. The current from the battery may flow into the vehicle's electrical/electronic system and cause system malfunction.

**⚠ WARNING**

**Electric shock**

Do not put a finger or a foreign object (pen, etc.) into a power outlet and do not touch with a wet hand. You may get an electric shock.

**Wireless smart phone charging system (if equipped)**

A wireless smart phone charging system is located in front of the center console.



[A]: Indicator, [B]: Charging pad

Firmly close all doors, and make sure to turn ON the ignition switch or press the ENGINE START/STOP button. To start wireless charging, place the smart phone equipped with wireless charging function on the wireless charging pad. For best wireless charging results, place the smart phone on the center of the charging pad.

The wireless charging system is designed for one smart phone equipped with Qi only. Please refer to the smart phone accessory cover or the smart phone manufacturer homepage to check whether your smart phone supports Qi function.

### **⚠ WARNING**

If any metallic object such as coins is located between the wireless charging system and the smart phone, the charging may be disrupted. Also, the metallic object may heat up.

### **Wireless smart phone charging**

1. Remove any object on the smart phone charging pad including the smart key. If there is any foreign object on the pad other than a smart phone, the wireless charging function may not operate properly.
2. Place the smart phone on the center of the wireless charging pad.
3. The indicator light will change to orange once the wireless charging

begins. After the charging is complete, the orange light will change to green.

4. You can choose to turn the wireless charging function to either ON or OFF by selecting the USM on the instrument cluster. Found in "Vehicle → Convenience → Wireless Charging System". (Please refer to "Instrument cluster" on page 5-75 for details).

### **\* INFORMATION**

The infotainment system may change after software updates. For more information, refer to the user's manual provided in the infotainment system and the quick reference guide.

If the wireless charging does not work, gently move your smart phone around the pad until the charging indicator light turns yellow. Depending on the smart phone, the charging indicator light may not turn green even after the charging is complete.

If the wireless charging is not functioning properly, the orange light will blink and flash for ten seconds then turn off. In such cases, remove the smart phone from the pad and replace it on the pad again, or double check the charging status.

If you leave the smart phone on the charging pad when the vehicle ignition is in OFF, the vehicle will alert you through warning messages and sound (applicable for vehicles with voice guidance function) after the 'Good bye' function on the instrument cluster ends.

For some manufacturers' smart phones, the system may not warn you even though the smart phone is left on the wireless charging unit. This is due to the particular characteristic of the smart



phone and not a malfunction of the wireless charging.

### **⚠ WARNING**

#### **Distracted driving**

Driving while distracted can result in a loss of vehicle control that may lead to an accident, severe bodily injury or death. The driver's primary responsibility is in the safe and legal operation of a vehicle. Any use of handheld devices, other equipment, or vehicle systems that take the driver's eyes, attention, and focus away from the safe operation of a vehicle are not permissible by law. These should never be used during the operation of the vehicle.

### **⚠ CAUTION**

#### **Liquid in wireless charging system**

To prevent liquid from damaging the wireless smart phone charging system in your vehicle, be sure not to spill liquid over the charging system.

### **⚠ CAUTION**

#### **Metal in wireless charging system**

If any metallic object such as a coin is located between the wireless charging system and the smart phone, the charging may be disrupted. Also, the metallic object may heat up and potentially damage the charging system. If there is any metallic object between the smart phone and the charging pad, immediately remove the smart phone. Remove the metallic object after it has cooled down.

### **⚠ CAUTION**

- When the interior temperature of the wireless charging system rises above

a set temperature, the wireless charging will cease to function. After the interior temperature drops below the threshold, the wireless charging function will resume.

- The wireless charging may not function properly when there is a heavy accessory cover on the smart phone.
- The wireless charging will stop when using the wireless smart key search function to prevent radio wave disruption.
- The wireless charging will stop when the smart key is moved out of the vehicle with the vehicle in ON.
- The wireless charging will stop when any of the doors are opened (applicable for vehicles equipped with smart keys).
- The wireless charging will stop when the vehicle is turned OFF.
- The wireless charging will stop when the smart phone is not in complete contact with the wireless charging pad.
- Items equipped with magnetic components such as credit card, telephone card, bankbook or any transportation ticket may become damaged during wireless charging.
- Place the smart phone on the center of the charge pad for best results. The smart phone may not charge when placed near the rim of the charging pad. When the smart phone does get charged, it may heat up excessively.
- For smart phones without built-in wireless charging system, an appropriate accessory has to be equipped in order to use the vehicle's wireless charging system.
- Certain smart phones may display messages on a weak current. This is

due to the particular characteristics of that smart phone, and does not imply a malfunction of the wireless charging function.

- The indicator light of some manufacturers' smart phones may still be orange after the smart phone is fully charged. This is due to the particular characteristic of the smart phone and not a malfunction of the wireless charging.
- When any smart phone without a wireless charging function or a metallic object is placed on the charging pad, a small noise may sound. This small noise is due to the vehicle discerning compatibility of the object placed on the charging pad. It does not affect your vehicle or the smart phone in any way.
- The wireless cellular phone charging system may not support certain cellular phones, which are not verified for the Qi specification (  ).
- When placing your smart phone on the charging pad, position the phone in the middle of the pad for maximum efficiency.  
If your smart phone is off to the side, the charging speed may slow down, and in some cases, your phone may experience higher heat conduction.
- When charging some smart phones with a self-protection feature, the wireless charging speed may decrease, and the charging may stop.
- A smart phone that supports the wireless charging can only be charged wirelessly.
- The wireless charging pad has an internal cooling system which can cre-

ate noise to keep your phone cool while it charges.

**This device complies with Industry Canada licence-exempt RSS standard(s).**

Operation is subject to the following two conditions:

1. This device may not cause interference, and
2. This device must accept any interference, including interference that may cause undesired operation of the device.

**Coat hook**

A Coat hook is next to the rear grab handle.



\* This actual feature may differ from the illustration.

**CAUTION**

**Hanging clothing**

Do not hang heavy clothes, since they may damage the hook.

**WARNING**

Do not hang other objects such as hangers or hard objects except clothes. Also, do not put heavy, sharp or breakable objects in the clothing's pockets. In an accident or when the curtain air bag is inflated, it may cause vehicle damage or body injury.



## Floor mat anchors



When using a floor mat on the front floor carpet, make sure it attaches to the floor mat anchors in your vehicle. This keeps the floor mat from sliding forward.

### **⚠ WARNING**

#### • **After market floor mat**

Do not install after market floor mats that are not capable of being securely attached to the vehicle's floor mat anchors.

Unsecured floor mats can interfere with pedal operation.

- Use floor mats not too thick and designed to be properly secured on the floor to avoid the interference with pedals. Make sure that installing the floor mats without removing plastic films on carpets may damage or break floor mat fix rings, resulting in the mats to be unsecured. Especially for a driver's seat, the unsecured mats may cause unintended acceleration/brake. Ensure to remove all the plastic films on the carpets before installing the mats.

The following must be observed when installing ANY floor mat to the vehicle.

- Ensure that the floor mats are securely attached to the vehicle's floor mat anchor(s) before driving the vehicle.
- Do not use ANY floor mat that cannot be firmly attached to the vehicle's floor mat anchors.
- Do not stack floor mats on top of one another (e.g., all-weather rubber mat on top of a carpeted floor mat). Only a single floor mat should be installed in each position.

## Luggage board (if equipped)

- If temporary tire or full size tire equipped in luggage, you can place reflector triangle in luggage.
- If TMK equipped in luggage, first aid kit, tools, etc can be placed in the box for easy access.



1. Grasp the handle on the top of the cover and lift it (1).
2. Fold the rear part of luggage board frontward.
3. Lift up upward luggage board frontward (Luggage board)

## Luggage net holder

To keep items from shifting in the cargo area, you can use the 4 holders located in the cargo area to attach the luggage net (if equipped), or you can fold the luggage net into half and attach it upwards by using the additional 2 holders located on each side.



If necessary, contact an authorized Kia dealer.

**CAUTION**

To prevent damage to the goods or the vehicle, be careful when carrying fragile or bulky objects in the luggage compartment.

**WARNING**

DO NOT over-stretch the luggage net and ALWAYS keep your face and body out of the luggage net's recoil path. Failure to comply with these instructions may result in severe facial injuries. DO NOT use the luggage net when the strap has visible signs of wear or damage.

**Cargo security screen (if equipped)**

**Installing cargo security screen**



- 1 Cargo security screen band
- 2 Cargo security screen cable

**Operation**

- 1. Take out the cargo security screen from the pouch. And slowly unfold the cargo security screen.
- 2. Attach the cargo security screen band (1) to the shopping bag hook.



- 3. After holding the cargo screen cable (2), insert it into the upper hook located under the rear glass and use it to fix it.



4. Removal of the cargo screen is the reverse of assembly.

### Storing cargo security screen

#### Operation

1. Hold the cargo screen corners of the side with the ling strings. And fold it in half.

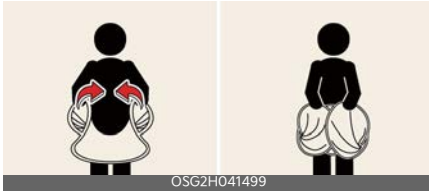

2. Turn your wrists to fold it and put it in the pouch.



#### **WARNING**

- Do not place objects on the cargo security screen. Such objects may move around inside the vehicle and possibly injure vehicle occupants during an accident or when braking.
- Never allow anyone to ride in the luggage compartment. It is designed for luggage only.
- Maintain the balance of the vehicle and locate the weight as forward as possible.

#### **CAUTION**

Do not unfold the cargo security screen near other people. The cargo security screen could spring causing injuries.

#### **\* NOTICE**

- Since the cargo security screen may be damaged or malformed, do not put luggage on it when it is used.
- Pull out the cargo security screen using the handle in the center to prevent the guide pin from falling out of the guide.
- The cargo security screen may not automatically slide back in if the cargo security screen is not fully pulled out. Fully pull it out and then let go.

## Exterior features

### Roof rack (if equipped)

If the vehicle has a roof rack, you can load cargo on top of your vehicle.



\* The actual shape may differ from the illustration.

Crossbars and fixing components needed to install the roof rack on your vehicle may be obtained from an authorized Kia dealer or other qualified shop.

#### \* NOTICE

- The crossbars (if equipped) should be placed in the proper load carrying positions prior to placing items onto the roof rack.
- If the vehicle is equipped with a sunroof, be sure not to position cargo onto the roof rack in such a way that it could interfere with sunroof operation.
- When the roof rack is not being used to carry cargo, the crossbars may need to be repositioned if wind noise is detected.

#### ⚠ CAUTION

- When carrying cargo on the roof rack, take the necessary precautions to make sure the cargo does not damage the roof of the vehicle.
- When carrying large objects on the roof rack, make sure they do not exceed the overall roof length or width.

- When you are carrying cargo on the roof rack, do not operate the sunroof. (if equipped)

#### ⚠ WARNING

- The following specification is the maximum weight that can be loaded onto the roof rack. Distribute the load as evenly as possible across the crossbars (if equipped) and roof rack and secure the load firmly.

ROOF LOAD	100 kg (220 lbs.) EVENLY DISTRIBUTED
-----------	-----------------------------------------

Loading cargo or luggage in excess of the specified weight limit on the roof rack may damage your vehicle.

- The vehicle center of gravity will be higher when items are loaded onto the roof rack. Avoid sudden starts, braking, sharp turns, abrupt maneuvers or high speeds that may result in loss of vehicle control or rollover resulting in an accident.
- Always drive slowly and turn corners carefully when carrying items on the roof rack. Severe wind updrafts, caused by passing vehicles or natural causes, can cause sudden upward pressure on items loaded on the roof rack. This is especially true when carrying large, flat items such as wood panels or mattresses. This could cause the items to fall off the roof rack and cause damage to your vehicle or others around you.
- To prevent damage or loss of cargo, FREQUENTLY check to ensure the cargo is securely fastened to the roof rack.

## Infotainment system

### \* NOTICE

If you install an aftermarket HID head lamp, your vehicle's audio and electronic device may malfunction.

### Using the infotainment/climate switchable controller



Press the button on the switchable controller to switch between infotainment system or climate control panel.

Press and hold the button to select the default mode for the control panel.

### Switching between panels

Infotainment control panel



OCV041316

Climate control panel



ONQ5031382L

Press the button on the switchable controller to select the desired control panel.

The selected control panel icon will appear and the control panel will be changed.

- The knob display will appear according to the selected control panel mode.
- When the vehicle is in the ACC position, only the infotainment system will be activated.

### Setting the default mode



Press and hold the button to select the default mode for the control panel.

- After the setting, the control panel will return to the default mode after a certain period of time even if the control panel is switched to the different mode.
- If the mode is set to 'OFF', the control panel will display the mode used recently.

### Audio system

#### \* NOTICE

If you install an aftermarket HID head-lamp, your vehicle's audio and electronic device may malfunction.

#### \* INFORMATION

The infotainment system may change after software updates. For more information, refer to the user's manual provided in the infotainment system and the quick reference guide.

### Shark-fin antenna

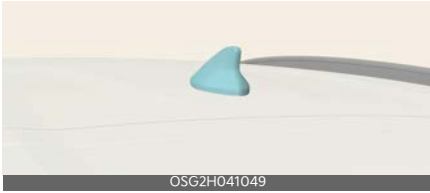

The sharkfin antenna transmits and receives wireless signals such as AM/FM, Sirius XM, GNSS, etc.

\* The signals which antenna can transmit and receive vary by the vehicle option.

#### \* NOTICE

- Be careful of antenna damage by checking the height of the vehicle before entering low-ceiling spaces such as automated parking lots or automated washing machines.
- Be careful not to contact the antenna when loading cargo on the roof rack. Antenna transmission/reception performance may be degraded.

### USB port

You can use the USB port to plug in an USB.



#### ⚠ CAUTION

Depending on the size, length, or shape of the USB stick, if you forcibly close the tray cover, the USB device may be damaged, deformed or the cover may not reopen as the device is stuck.

When the stick is stuck, forcibly opening the cover can also cause damage to the device.

If the USB stick does not fit into the space, do not close the cover and try another USB stick with different specifications.

### How vehicle radio works

#### FM reception

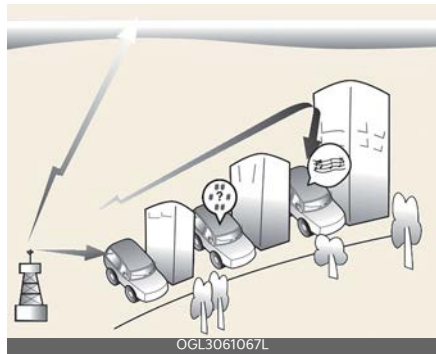

AM and FM radio signals are broadcast from transmitter towers located around your city. They are intercepted by the radio antenna on your vehicle. This signal is then processed by the radio and sent to your vehicle speakers.

However, in some cases the signal coming to your vehicle may not be strong and clear.

This can be due to factors, such as the distance from the radio station, closeness of other strong radio stations or the presence of buildings, bridges or other large obstructions in the area.



## AM reception

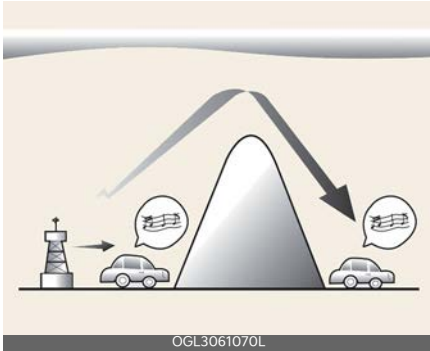

AM broadcasts can be received at greater distances than FM broadcasts. This is because AM radio waves are transmitted at low frequencies. These long distance, low frequency radio waves can follow the curvature of the earth rather than traveling straight. In addition, they curve around obstructions resulting in better signal coverage.

## FM radio station

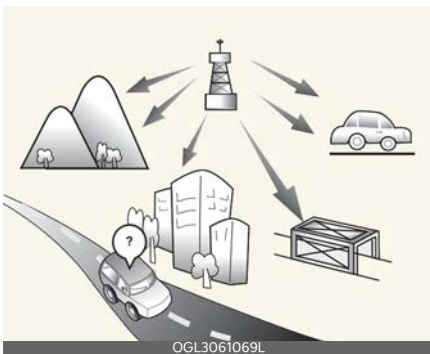

FM broadcasts are transmitted at high frequencies and do not bend to follow the earth's surface. Because of this, FM broadcasts generally begin to fade within short distances from the station. Also, FM signals are easily affected by buildings, mountains, and obstructions.

This can lead to undesirable or unpleasant listening conditions which might lead you to believe a problem exists with your radio.

The following conditions are normal and do not indicate radio trouble:

- **Fading** - As your vehicle moves away from the radio station, the signal will weaken and sound will begin to fade. When this occurs, we suggest that you select another station with a stronger signal.

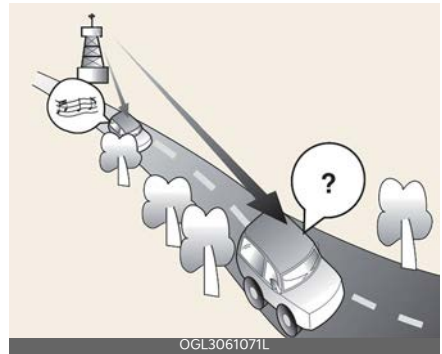

- **Flutter/Static** - Weak FM signals or large obstructions between the transmitter and your radio can disturb the signal causing static or fluttering noises to occur. Reducing the treble level may lessen this effect until the disturbance clears.
- **Station Swapping** - As an FM signal weakens, another more powerful signal near the same frequency may begin to play. This is because your radio is designed to lock onto the clearest signal. If this occurs, select another station with a stronger signal.

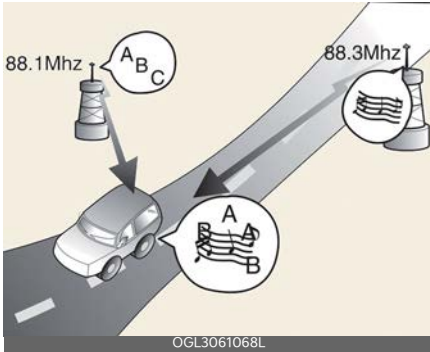

- Multi-Path Cancellation - Radio signals being received from several directions can cause distortion or fluttering. This can be caused by a direct and reflected signal from the same station, or by signals from two stations with close frequencies. If this occurs, select another station until the condition has passed.

### Using a cellular phone or a two-way radio

When a cellular phone is used inside the vehicle, noise may be produced from the audio system. This does not mean that something is wrong with the audio equipment. In such a case, try to operate mobile devices as far from the audio equipment as possible.

When using a communication system such as a cellular phone or a radio set inside the vehicle, a separate external antenna must be fitted. When a cellular phone or a radio set is used with only the internal antenna, it may interfere with the vehicle's electrical system and adversely affect the safe operation of the vehicle.

### **WARNING**

#### **Cell phone use**

Do not use a cellular phone while driving. Stop at a safe location to use a cellular phone.

### **WARNING**

#### **Distracted driving**

Driving while distracted can result in a loss of vehicle control that may lead to an accident, severe bodily injury, or death. The driver's primary responsibility is in the safe and legal operation of a vehicle. Any use of handheld devices, other equipment, or vehicle systems that take the driver's eyes, attention, and focus away from the safe operation of a vehicle are not permissible by law. These should never be used during the operation of the vehicle.

## Declaration of Conformity

### IC

This device complies with Industry Canada's licence-exempt RSSs.

Operation is subject to the following two conditions:

1. This device may not cause interference; and
2. This device must accept any interference, including interference that may cause undesired operation of the device.

Le présent appareil est conforme aux CNR d'Industrie Canada applicables aux appareils radio exempts de licence.

L'exploitation est autorisée aux deux conditions suivantes:

1. l'appareil ne doit pas produire de brouillage, et
2. l'utilisateur de l'appareil doit accepter tout brouillage radioélectrique subi, même si le brouillage est susceptible d'en compromettre le fonctionnement.

### CAUTION

Any changes or modifications to this device that is not explicitly approved by the manufacturer could void your authority to operate this equipment.

---



<b>Be sure the exhaust system does not leak.....</b>	<b>6-7</b>
<b>Before driving .....</b>	<b>6-7</b>
<b>Key positions.....</b>	<b>6-9</b>
• Illuminated ignition switch .....	6-9
• Ignition switch position .....	6-9
• Starting the engine .....	6-10
<b>ENGINE START/STOP button .....</b>	<b>6-11</b>
• Illuminated ENGINE START/STOP button.....	6-11
• Ignition key interlock system .....	6-11
• ENGINE START/STOP button position .....	6-11
• Starting the engine .....	6-12
<b>Dual clutch transmission (DCT) (Shift Lever) .....</b>	<b>6-14</b>
• Dual clutch transmission operation .....	6-14
• DCT warning messages .....	6-16
• Transmission ranges .....	6-17
• Shift lock system .....	6-20
• Good driving practices .....	6-20
<b>Dual clutch transmission (DCT) (Dial SBW).....</b>	<b>6-22</b>
• Dual clutch transmission operation .....	6-22
• DCT warning messages .....	6-23
• Transmission ranges .....	6-25
• LCD display messages.....	6-27
• Shift-lock system .....	6-29
• Good driving practices .....	6-29
<b>Paddle shifter .....</b>	<b>6-30</b>
• Manual mode.....	6-30
• Regenerative braking mode.....	6-31
<b>Smart regeneration system .....</b>	<b>6-33</b>
• Setting smart regeneration system.....	6-33
• Smart regeneration system activation .....	6-33

# 6 Driving your vehicle

• Resuming smart regeneration system .....	6-34
• Basic setting of smart regeneration system .....	6-35
• Vehicle-to-vehicle distance recognition sensor .....	6-35
• System malfunction .....	6-35
• Limitations of the system .....	6-36
<b>Brake system .....</b>	<b>6-38</b>
• Power brakes .....	6-38
• Electronic Parking Brake (EPB) .....	6-40
• Brake Disc Cleaning (BDC) .....	6-44
• AUTO HOLD .....	6-44
• Anti-lock Brake System (ABS) .....	6-46
• Electronic Stability Control (ESC) system .....	6-48
• Hill-start Assist Control (HAC) .....	6-50
• Vehicle Stability Management (VSM) system .....	6-50
• Brake Assistant System (BAS) .....	6-51
• Good braking practices .....	6-52
<b>Vehicle Auto Shut-off system .....</b>	<b>6-54</b>
• Operating Conditions .....	6-54
• Deactivating Conditions .....	6-54
• System Operation .....	6-54
<b>Drive mode integrated control system .....</b>	<b>6-55</b>
• Drive mode .....	6-55
<b>Green Zone Drive Mode .....</b>	<b>6-56</b>
• Green Zone Drive Mode LCD display .....	6-56
• Green zone registration point .....	6-57
<b>Active air flap .....</b>	<b>6-57</b>
• Active air flap malfunction .....	6-57
<b>Forward Collision-Avoidance Assist (FCA) (Front Camera Only) .....</b>	<b>6-58</b>
• Forward Collision-Avoidance Assist settings .....	6-59
• Forward Collision-Avoidance Assist operation .....	6-61

- Forward Collision-Avoidance Assist malfunction and limitations.....6-63
- Forward Collision-Avoidance Assist (FCA) (Sensor Fusion). 6-68**
- Forward Collision-Avoidance Assist settings ..... 6-70
- Forward Collision-Avoidance Assist operation ..... 6-71
- Forward Collision-Avoidance Assist malfunction and limitations.....6-74
- Lane Keeping Assist (LKA)..... 6-80**
- Lane Keeping Assist settings .....6-80
- Lane Keeping Assist operation.....6-82
- Lane Keeping Assist malfunction and limitations.....6-83
- Blind-Spot Collision-Avoidance Assist (BCA) ..... 6-85**
- Blind-Spot Collision-Avoidance Assist settings..... 6-86
- Blind-Spot Collision-Avoidance Assist operation ..... 6-88
- Blind-Spot Collision-Avoidance Assist malfunction and limitations..... 6-90
- Safe Exit Warning (SEW) ..... 6-94**
- Safe Exit Warning settings .....6-95
- Safe Exit Warning operation .....6-95
- Safe Exit Warning malfunction and limitations .....6-96
- Safe Exit Assist (SEA) ..... 6-98**
- Safe Exit Assist settings..... 6-98
- Safe Exit Assist operation .....6-99
- Safe Exit Assist malfunction and limitations ..... 6-100
- Manual Speed Limit Assist (MSLA) ..... 6-102**
- Manual Speed Limit Assist operation..... 6-102
- Intelligent Speed Limit Assist (ISLA)..... 6-104**
- Intelligent Speed Limit Assist settings..... 6-105
- Intelligent Speed Limit Assist operation..... 6-107
- Intelligent Speed Limit Assist malfunction and limitations..... 6-108

# 6 Driving your vehicle

<b>Driver Attention Warning (DAW)</b> .....	<b>6-110</b>
• Driver Attention Warning settings .....	6-111
• Driver Attention Warning operation .....	6-111
• Driver Attention Warning malfunction and limitations .....	6-113
<b>Cruise Control (CC)</b> .....	<b>6-115</b>
• Cruise Control operation .....	6-115
<b>Smart Cruise Control (SCC)</b> .....	<b>6-118</b>
• Smart Cruise Control settings .....	6-119
• Smart Cruise Control operation.....	6-120
• Smart Cruise Control malfunction and limitations.....	6-126
<b>Navigation-based Smart Cruise Control (NSCC)</b> .....	<b>6-131</b>
• Navigation-based Smart Cruise Control settings .....	6-132
• Navigation-based Smart Cruise Control operation .....	6-132
• Limitations of Navigation-based Smart Cruise Control .....	6-134
• This device complies with Industry Canada licence-exempt RSS standard(s).....	6-136
<b>Lane Following Assist (LFA)</b> .....	<b>6-136</b>
• Lane Following Assist settings .....	6-136
• Lane Following Assist operation.....	6-137
• Lane Following Assist malfunction and limitations.....	6-139
<b>Highway Driving Assist (HDA)</b> .....	<b>6-139</b>
• Highway Driving Assist settings .....	6-140
• Highway Driving Assist operation .....	6-141
• Highway Driving Assist malfunction and limitations.....	6-143
<b>Rear View Monitor (RVM)</b> .....	<b>6-146</b>
• Rear View Monitor settings .....	6-146
• Rear View Monitor operation.....	6-147
• Rear View Monitor malfunction and limitations.....	6-148
<b>Rear Cross-Traffic Collision-Avoidance Assist (RCCA)</b> .....	<b>6-149</b>
• Rear Cross-Traffic Collision-Avoidance Assist settings .....	6-150



• Rear Cross-Traffic Collision-Avoidance Assist operation.....	6-151
• Rear Cross-Traffic Collision-Avoidance Assist malfunction and limitations.....	6-154
<b>Reverse Parking Distance Warning (PDW).....</b>	<b>6-157</b>
• Reverse Parking Distance Warning settings.....	6-157
• Reverse Parking Distance Warning operation.....	6-158
• Reverse Parking Distance Warning malfunction and precautions.....	6-159
<b>Forward/Reverse Parking Distance Warning (PDW) .....</b>	<b>6-160</b>
• Forward/Reverse Parking Distance Warning settings.....	6-161
• Parking Distance Warning operation.....	6-161
• Parking Distance Warning malfunction and limitations.....	6-163
<b>Reverse Parking Collision-Avoidance Assist (PCA).....</b>	<b>6-165</b>
• Parking Collision-Avoidance Assist settings.....	6-165
• Parking Collision-Avoidance Assist operation.....	6-167
• Parking Collision-Avoidance Assist malfunction and limitations.....	6-168
<b>Remote Smart Parking Assist (RSPA).....</b>	<b>6-172</b>
• Remote Smart Parking Assist settings.....	6-173
• Remote Smart Parking Assist operation.....	6-174
• Remote Smart Parking Assist malfunction and limitations.....	6-179
<b>Declaration of conformity .....</b>	<b>6-183</b>
<b>Economical operation .....</b>	<b>6-184</b>
<b>Special driving conditions .....</b>	<b>6-185</b>
<b>Winter driving.....</b>	<b>6-189</b>
<b>Vehicle load limit .....</b>	<b>6-192</b>
• Steps For Determining Correct Load Limit-.....	6-192
• Certification label.....	6-194
<b>Vehicle weight .....</b>	<b>6-195</b>
• Base curb weight.....	6-195

## 6 Driving your vehicle

- Vehicle curb weight ..... 6-195
- Cargo weight..... 6-195
- GAW (Gross axle weight)..... 6-195
- GAWR (Gross axle weight rating)..... 6-196
- GVW (Gross vehicle weight) ..... 6-196
- GVWR (Gross vehicle weight rating) ..... 6-196
- Overloading..... 6-196

## Driving your vehicle

### Be sure the exhaust system does not leak.

The exhaust system should be checked whenever the vehicle is raised to change the oil or for any other purpose.

If you hear a change in the sound of the exhaust or if you drive over something that strikes the underneath side of the vehicle, have the exhaust system checked as soon as possible by an authorized Kia dealer.

#### **WARNING**

#### Engine exhaust

Do not inhale exhaust fumes or leave your engine running in an enclosed area for a prolonged time. Exhaust fumes contain carbon monoxide, a colorless and odorless gas that can cause unconsciousness and death by asphyxiation.

#### **WARNING**

#### Open liftgate

Do not drive with the liftgate open. Poisonous exhaust gases can enter the passenger compartment. If you must drive with the liftgate open proceed as follows:

1. Close all windows.
2. Open side vents.
3. Set the air intake control at "Fresh", the air flow control at "Floor" or "Face", and the fan at the highest speed.

## Before driving

Before getting into the vehicle, you should examine the vehicle and its surroundings. After getting into the vehicle, you should check a number of things before driving.

### Before entering vehicle

- Be sure that all windows, outside mirror(s), and outside lights are clean.
- Check the condition of the tires.
- Check under the vehicle for any sign of leaks.
- Be sure there are no obstacles behind you if you intend to back up.

### Necessary inspections

Fluid levels, such as engine oil, engine coolant, brake fluid, and washer fluid should be checked on a regular basis, at the exact interval depending on the fluid. Further details are provided in "Maintenance" on page 8-4.

#### **WARNING**

#### Distracted driving

Focus on the road while driving. The driver's primary responsibility is in the safe and legal operation of the vehicle. Use of any hand-held devices, other equipment or vehicle systems that distract the driver should not be used during vehicle operation.

## Before starting

- Close and lock all doors.
- Position the seat so that all controls are easily reached.
- Buckle your seat belt.
- Adjust the inside and outside rear view mirrors.
- Be sure that all lights work.
- Check all gauges.
- Check the operation of warning lights when the ENGINE START/STOP button is turned to the ON position.
- Release the parking brake and make sure the brake warning light is not on.

For safe operation, be sure you are familiar with your vehicle and its equipment.

### WARNING

When you intend to park or stop the vehicle with the engine on, be careful not to depress the accelerator pedal for a long period of time. It may overheat the engine or exhaust system and cause fire.

### WARNING

#### Check surroundings

Always check the surrounding areas near your vehicle for people, especially children, before putting a vehicle into D (Drive) or R (Reverse).

### WARNING

#### Loose objects

Securely store items in your vehicle. When you make a sudden stop or turn the steering wheel rapidly, loose objects may drop on the floor and it could inter-

fer with the operation of the foot pedals, possibly causing an accident.

### WARNING

#### Driving under the influence

Do not drive while under the influence of alcohol, drugs, or other impairing substances. Drinking and driving is dangerous. Even a small amount of alcohol will affect your reflexes, perceptions and judgment.

Driving while under the influence of drugs or other impairing substances is as dangerous as or more dangerous than driving drunk.

### WARNING

#### Proper footwear

Always wear appropriate shoes when operating your vehicle. Unsuitable shoes (high heels, ski boots, sandals, etc.) may interfere with your ability to use the brake and accelerator pedals.

## Key positions (if equipped)

Your vehicle is equipped with four different ignition positions.

### Illuminated ignition switch

Whenever a front door is opened, the ignition switch will illuminate for your convenience, provided the ignition switch is not in the ON position.

The light will go off immediately when the ignition switch is turned on. It will also go off after about 30 seconds when the door is closed.

### Ignition switch position

Your vehicle is equipped with four different ignition positions.



### LOCK (1)

The ignition key can be removed only in the LOCK position.

### ACC (Accessory) (2)

The electrical accessories are operative. If difficulty is experienced turning the ignition switch to the ACC position, turn the key while turning the steering wheel right and left to release the tension.

### ON (3)

The warning lights can be checked before the engine is started. This is the normal running position after the engine is started.

Do not leave the ignition switch ON if the engine is not running to prevent battery discharge.

### START (4)

Turn the ignition switch to the START position to start the engine. The engine will crank until you release the key; then it returns to the ON position. The brake warning light can be checked in this position.

### ⚠ WARNING

#### Ignition switch

Never turn the ignition switch to LOCK or ACC while the vehicle is moving. This would result in loss of directional control and braking function, which could cause an accident.

### \* NOTICE

If you leave the ignition switch to the ACC or ON position for a long time, the battery may discharge.

**⚠ WARNING****Key holder**

Do not attach small purses, multiple keys, or any other heavy accessories to the driver's key chain used to start the vehicle. This may cause the driver to accidentally make the key inserted in the vehicle to change the ignition position to the ACC position while the vehicle is moving thereby increasing the risk of an accident and causing the deactivation of several safety features.

**⚠ WARNING****Leaving the vehicle**

To avoid unexpected or sudden vehicle movement, never leave your vehicle if the gear is not locked in the P (Park) position and the parking brake is fully engaged. Before leaving the driver's seat, always make sure the gear is shifted to P (Park) position, set the parking brake fully and shut the engine off.

**Starting the engine**

1. Make sure the parking brake is applied.
2. Make sure the gear is shifted to P (Park) position. Depress the brake pedal fully.
3. Turn the ignition switch to START and hold it there until the engine starts (a maximum of 10 seconds), then release the key.

It should be started **without depressing the accelerator pedal**.

4. Do not wait for the engine to warm up while the vehicle remains stationary. Start driving at moderate engine speeds. (Steep accelerating and decelerating should be avoided.)

**⚠ WARNING****Steering wheel**

Never reach for any controls through the steering wheel while the vehicle is in motion. The presence of your hand or arm in this area could cause a loss of vehicle control.

If the engine stalls while you are in motion, do not attempt to move the shifter dial to the P (Park) position. If traffic and road conditions permit, you may put the shifter dial in the N (Neutral) position while the vehicle is still moving and turn the ignition switch to the START position in an attempt to restart the engine.

**⚠ CAUTION****Starter**

Do not engage the starter for more than 10 seconds. If the engine stalls or fails to start, wait 5 to 10 seconds before reengaging the starter. Improper use of the starter may damage it.

## ENGINE START/STOP button (if equipped)

### Illuminated ENGINE START/STOP button



The light will go off after about 30 seconds when the door is closed. It will also go off immediately when the theft-alarm system is armed.

### Ignition key interlock system

The ignition key cannot be removed unless the vehicle is in P (Park).

- Never turn the ignition switch to LOCK or ACC while the vehicle is moving. This would result in loss of directional control and braking function, which could cause an accident.
- Do not attach small purses, multiple keys, or any other heavy accessories to the driver's key chain used to start the vehicle. This may cause the driver to accidentally make the key inserted in the vehicle to change the ignition position to the ACC position while the vehicle is moving thereby increasing the risk of an accident and causing the deactivation of several safety features.
- To avoid unexpected or sudden vehicle movement, never leave your vehicle if the gear is not locked in the P (Park) position and the parking brake is fully engaged. Before leaving the driver's seat, always make sure the gear is shifted to P (Park) position, set

the parking brake fully and shut the engine off.

### \* NOTICE

If you leave the ignition switch to the ACC or ON position for a long time, the battery may discharge.

### ENGINE START/STOP button position

Your vehicle is equipped with four different ignition positions.

#### OFF

To turn off the engine (START/RUN position) or vehicle power (ON position), press the ENGINE START/STOP button with the gear in the P (Park) position. When you press the ENGINE START/STOP button without the gear in the P (Park) position, the ENGINE START/STOP button will not change to the OFF position but to the ACC position.

## ACC (Accessory)



### A: ACCESSORY

Press the ENGINE START/STOP button while it is in the OFF position without depressing the brake pedal.

The electrical accessories are operational.

If the ENGINE START/STOP button is in the ACC position for more than 1 hour, the button is turned off automatically to prevent battery discharge.

### ON

Press the ENGINE START/STOP button while it is in the ACC position without depressing the brake pedal.

The warning lights can be checked before the engine is started. Do not leave the ENGINE START/STOP button in the ON position for a long time. The battery may discharge, because the engine is not running.

### \* NOTICE

If you leave the ENGINE START/STOP button in the ACC or ON position for a long time, the battery will discharge.

## START/RUN

To start the engine, depress the brake pedal and press the ENGINE START/STOP button with the gear in the P (Park) or the N (Neutral) position. For

your safety, start the engine with the gear in the P (Park) position.

### \* NOTICE

If you press the ENGINE START/STOP button without pressing the brake pedal, the engine will not start and the ENGINE START/STOP button changes as follow:

OFF → ACC → ON → OFF or ACC

### ⚠ WARNING

- Never press the ENGINE START/STOP button while the vehicle is in motion. This would result in loss of directional control and braking function, which could cause an accident.
- Before leaving the driver's seat, always make sure the gear is shifted to P (Park) position, set the parking brake fully and shut the engine off. Unexpected and sudden vehicle movement may occur if these precautions are not taken.
- Never reach for controls through the steering wheel while the vehicle is in motion. The presence of your hand or arm in the area could cause loss of vehicle control, an accident and serious bodily injury or death.
- Do not place any movable objects around the driver's seat as they may move while driving, interfere with the driver and lead to an accident.

## Starting the engine

### ⚠ WARNING

- Do not start the vehicle with the accelerator pedal engaged. The vehicle can move and lead to an accident.
- Wait until the engine rpm is normal. The vehicle may suddenly move if the



brake pedal is released when the rpm is high.

## Starting the engine with smart key

At the time that the vehicle doors are opened or when the ENGINE START/STOP button is pressed the vehicle will check for the smart key.

If the smart key is not in the vehicle, the "🔑" indicator and a message "Key is not in the vehicle" will appear on the instrument cluster and LCD window. And if all doors are closed, the chime will sound for 5 seconds. The indicator or warning will turn off while the vehicle is moving. Always have the smart key with you.

### ⚠️ WARNING

The engine will start, only when the smart key is in the vehicle. Never allow children or any person who is unfamiliar with the vehicle touch the ENGINE START/STOP button or related parts. Pushing the ENGINE START/STOP button while the smart key is in the vehicle may result in unintended engine activation and/or unintended vehicle movement.

### ⚠️ CAUTION

If the engine stalls while the vehicle is in motion, do not attempt to move the gear to the P (Park) position. If the traffic and road conditions permit, you may put the gear in the N (Neutral) position while the vehicle is still moving and press the ENGINE START/STOP button in an attempt to restart the engine.

### \* NOTICE

- If the battery is weak or the smart key does not work correctly, you can start the engine by pressing the ENGINE START/STOP button with the smart key.

When you press the ENGINE START/STOP button directly with the smart key, the smart key should contact the button at a right angle.



- When the stop lamp fuse is blown, you cannot start the engine normally. Replace the fuse with a new one. If it is not possible, you can start the engine by pressing the ENGINE START/STOP button for 10 seconds while it is in the ACC position. The engine can start without pressing the brake pedal. But for your safety always press the brake pedal before starting the engine.

### ⚠️ CAUTION

- Do not press the ENGINE START/STOP button for more than 10 seconds except when the stop lamp fuse is blown.

### Starting the engine

1. Carry the smart key or leave it inside the vehicle.
2. Make sure the parking brake is firmly applied.
3. Make sure the gear is shifted to P (Park) position. Depress the brake pedal fully.
4. Press the ENGINE START/STOP button.  
It should be started without depressing the accelerator pedal.
5. Do not wait for the engine to warm up while the vehicle remains stationary. Start driving at moderate engine speeds. (Steep accelerating and decelerating should be avoided.)

### Starting the gasoline engine

#### Operation

1. Make sure the parking brake is applied.
2. Make sure the gear is in P (Park).
3. Fully depress the brake pedal.
4. Turn the key to START position or press the ENGINE START/STOP button.

### Dual clutch transmission (DCT) (Shift Lever) (if equipped)

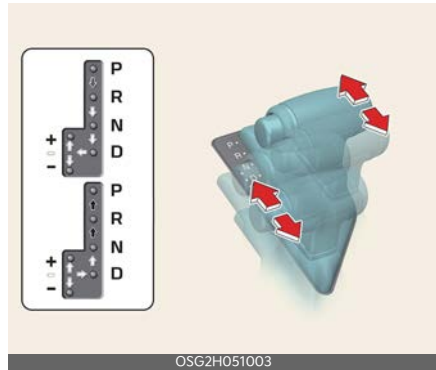

 Depress the brake pedal and press the shift button while moving the shift lever.

 Press the shift button while moving the shift lever.

 The shift lever can be shifted freely.

\* To move the shift lever from/to P (Parking) or between R (Reverse) and D (Drive), you must depress the brake pedal for the vehicle to stand still.

### Dual clutch transmission operation

The dual clutch transmission has 6 forward speeds and one reverse speed. The individual speeds are selected automatically in the D (Drive) position.

- The dual clutch transmission can be thought of as an automatically shifting manual transmission. It gives the driving feel of a manual transmission, yet provides the ease of a fully automatic transmission.
- When D (Drive) is selected, the transmission will automatically shift through the gears similar to a conven-

tional automatic transmission. Unlike a traditional automatic transmission, the gear shifting can sometimes be felt and heard as the actuators engage the clutches and the gears are selected.

- The dual clutch transmission incorporates a dry-type dual clutch mechanism, which allows for better acceleration performance and increased fuel efficiency while driving. But it differs from a conventional automatic transmission because it does not incorporate a torque converter. Instead, the transition from one gear to the next is managed by the clutch slip, especially at lower speeds. As a result, shifts are sometimes more noticeable, and a light vibration can be felt as the transmission shaft speed is matched with the engine shaft speed. This is a normal condition of the dual clutch transmission.
- The dry-type clutch transfers torque more directly and provides a direct-drive feeling which may feel different from a conventional automatic transmission. This may be more noticeable when launching the vehicle from a stop or when traveling at low, stop-and-go vehicle speeds.
- When rapidly accelerating from a lower vehicle speed, the engine RPM may increase dramatically as a result of the clutch slip as the dual clutch transmission selects the correct gear. This is a normal condition.
- When accelerating from a stop on an incline, press the accelerator smoothly and gradually to avoid any shudder feeling or jerkiness.
- When traveling at a lower vehicle speed, if you release the accelerator

pedal quickly, you may feel engine braking before the transmission changes gears. This engine braking feeling is similar to operating a manual transmission at low speed.

- When driving downhill, you may wish to move the gear shift lever to Manual Shift mode and downshift to a lower gear in order to control your speed without using the brake pedal excessively.
- When you turn the engine on and off, you may hear clicking sounds as the system goes through a selftest. This is a normal sound for the dual clutch transmission.
- During the first 1,500 km (1000 miles), you may feel that the vehicle may not be smooth when accelerating at low speed. During this break-in period, the shift quality and performance of your new vehicle is continuously optimized.

### **WARNING**

To reduce the risk of serious injury or death:

- ALWAYS check the surrounding areas near your vehicle for people, especially children, before shifting a vehicle into D (Drive) or R (Reverse).
- Before leaving the driver's seat, always make sure the shift lever is in the P (Park) position, then set the parking brake, and place the ignition switch in the LOCK/OFF position. Unexpected and sudden vehicle movement can occur if these precautions are not followed.
- Do not use aggressive engine braking (shifting from a higher gear to a lower gear) on slippery roads. This could

cause the tires to slip and may result in an accident.

**\* NOTICE**

- Always come to a complete stop before shifting into D (Drive) or R (Reverse).
- Do not put the shift lever in N (Neutral) while driving.

**⚠ WARNING**

If the transmission cannot shift into Drive or Reverse, the position indicator D or R) on the cluster will blink. Have the system checked by an authorized Kia dealer.

**DCT warning messages**

**Steep grade**

This warning message is displayed when vehicle is driven slowly on a grade and the vehicle detects that the brake pedal is not applied.

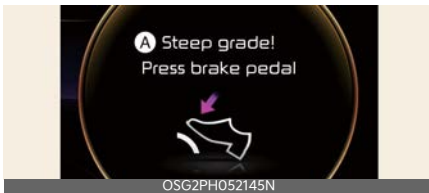

**A: Steep grade! Press brake pedal**

Driving up hills or on steep grades:

- To hold the vehicle on an incline use the foot brake or the parking brake.
- When in stop-and-go traffic on an incline, keep some distance ahead before moving the vehicle forward. Then hold the vehicle on the incline with the foot brake.

- If the vehicle is held on a hill by applying the accelerator pedal or by creeping with brake pedal disengaged, the clutch and transmission may overheat which can result in damage. At this time, a warning message will appear on the LCD display.
- If the LCD warning is active, the foot brake must be applied.
- Ignoring the warnings can lead to damage to the transmission.

**Transmission high temperature**

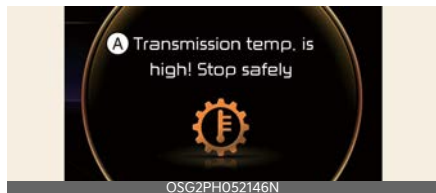

**A: Transmission temp. is high! Stop safely**

- Under certain conditions, such as repeated stop-and-go launches on steep grades, sudden take off or acceleration, or other harsh driving conditions, the transmission clutch temperatures will increase excessively.
- When the clutch is overheated, the safe protection mode engages and the gear position indicator on the cluster blinks with a chime. At this time, "Transmission temp. is high! Stop safely" warning message will appear on the LCD display and driving may not be smooth.
- If this occurs, pull over to a safe location, stop the vehicle with the engine running, apply the parking brake after shifting the vehicle to N (Neutral) with the brake pedal depressed, and allow the transmission to cool.

- If you ignore this warning, the driving condition may become worse. You may experience abrupt shifts, frequent shifts, or jerkiness. To return to the normal driving condition, stop the vehicle and apply the foot brake or shift into P (Park).

Then allow the transmission to cool for a few minutes with engine on, before driving off.

- When possible, drive the vehicle smoothly.

## Transmission overheated

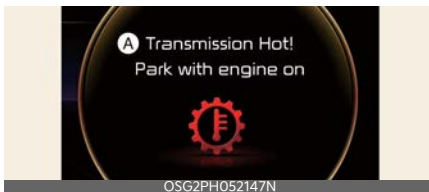

### A: Transmission Hot! Park with engine on

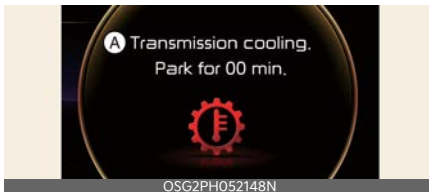

### A: Transmission cooling. Park for 00 min.

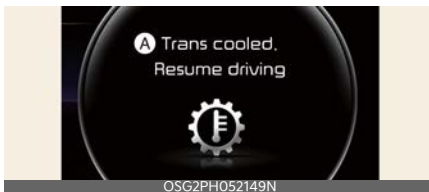

### A: Trans cooled. Resume driving

- If the vehicle continues to be driven and the clutch temperatures reach the maximum temperature limit, the

"Transmission hot! Park with engine On" warning will be displayed. When this occurs the clutch is disabled until the clutch cools to normal temperatures.

- The warning will display a time to wait for the transmission to cool.
- If this occurs, pull over to a safe location, stop the vehicle with the engine running, apply the brakes and shift the vehicle to P (Park), and allow the transmission to cool.
- When the message "Transmission cooled down. Resume driving" appears you can continue to drive your vehicle.
- When possible, drive the vehicle smoothly.

If any of the warning messages in the LCD display continue to blink, for your safety, Have the system checked by an authorized Kia dealer.

## Transmission ranges

The indicator in the instrument cluster displays the shift lever position when the ignition switch is in the ON position.

### P (Park)

Always come to a complete stop before shifting into P (Park).

To shift from P (Park), you must depress firmly on the brake pedal and make sure your foot is off the accelerator pedal.

If you have done all of the above and still cannot shift the lever out of P (Park), see "Shift-Lock Release" in this chapter.

The shift lever must be in P (Park) before turning the engine off.

**⚠ WARNING**

- Shifting into P (Park) while the vehicle is in motion may cause you to lose control of the vehicle.
- After the vehicle has stopped, always make sure the shift lever is in P (Park), apply the parking brake, and turn the engine off.
- When parking on an incline, block the wheels to prevent the vehicle from rolling down.
- For safety, always engage the parking brake with the shift lever in the P (Park) position except for the case of emergency parking.

**R (Reverse)**

Use this position to drive the vehicle backward.

**⚠ CAUTION**

Always come to a complete stop before shifting into or out of R (Reverse); you may damage the transmission if you shift into R (Reverse) while the vehicle is in motion.

**N (Neutral)**

The wheels and transmission are not engaged.

**⚠ WARNING**

Do not shift into gear unless your foot is firmly on the brake pedal. Shifting into gear when the engine is running at high speed can cause the vehicle to move very rapidly. You could lose control of the vehicle and hit people or objects.

**⚠ WARNING**

Do not drive with the shift lever in N (Neutral).

The engine brake will not work and lead to an accident.

**Parking in N (Neutral) gear**

Follow below steps when parking and you want the vehicle to move when pushed.

1. After parking your vehicle, step on the brake pedal and move the shift lever to P (Park) with the ignition button in ON or while the engine is running.
2. If the parking brake is applied unlock the parking brake.
  - For EPB (Electronic Parking Brake) equipped vehicles, push the brake pedal with the ignition switch or ENGINE START/STOP button in ON or while the engine is running to disengage the parking brake. If AUTO HOLD function is used while driving (If AUTO HOLD indicator is on in the cluster), press AUTO HOLD switch and AUTO HOLD function should be turn off.
3. while pressing the brake pedal, turn the ignition button OFF.
  - For smart key equipped vehicles, the ignition switch can be moved to OFF only when the shift lever is in P (Park).
4. Change the gear shift lever to N (Neutral) while pressing the brake pedal and pushing SHIFT LOCK RELEASE button or inserting, pressing down a tool (e.g., flathead screw-driver) into the SHIFT LOCK RELEASE access hole at the same time. Then, the vehicle

will move when external force is applied.

### **⚠ WARNING**

#### **Parking In Neutral**

- With the exception of parking in neutral gear, always park the vehicle in P (Park) for safety and engage the parking brake.
- Before parking in N (Neutral) gear, first make sure the parking ground is level and flat. Do not park in N (Neutral) gear on any slopes or gradients. If parked and left in N (Neutral), the vehicle may move and cause serious damage and injury.
- After the ignition switch or ENGINE START/STOP button has been turned off, the Electronic Parking Brake cannot be disengaged.
- For EPB (Electronic Parking Brake) equipped vehicles with AUTO HOLD function used while driving, if the ignition switch or ENGINE START/STOP button has been turned OFF, the Electronic Parking Brake will be engaged automatically. Therefore, AUTO HOLD function should be turned off before the ignition button is turned off.

#### **D (Drive)**

This is the normal driving position. The transmission will automatically shift through a 6 gear sequence, providing the best fuel economy and power.

For extra power when passing another vehicle or driving uphill depress the accelerator pedal further until you feel the transmission downshift to a lower gear.

To stop the vehicle during driving, please press brake pedal fully to prevent unintended movement.

#### **Manual mode**



Whether the vehicle is stationary or in motion, manual mode is selected by pushing the shift lever from the D (Drive) position into the manual gate. To return to D (Drive) range operation, push the shift lever back into the main gate.

Manual mode manages the driving dynamics by automatically adjusting the steering effort, and the engine and transmission control logic for enhanced driver performance.

In manual mode, moving the shift lever backwards and forwards will allow you to make gearshifts rapidly. In contrast to a manual transmission, the manual mode allows gearshifts with the accelerator pedal depressed.

- Up (+): Push the lever forward once to shift up one gear.
- Down (-): Pull the lever backwards once to shift down one gear.

### **\* NOTICE**

- Only the six forward gears can be selected. To reverse or park the vehicle, move the shift lever to the R (Reverse) or P (Park) position as required.
- Downshifts are made automatically when the vehicle slows down. When

the vehicle stops, 1st gear is automatically selected.

- When the engine rpm approaches the red zone the transmission will upshift automatically.
- If the driver presses the lever to + Up) or - (Down) position, the transmission may not make the requested gear change if the next gear is outside of the allowable rpm range.

## Shift lock system

For your safety, the Dual clutch transmission has a shift lock system which prevents shifting the transmission from P (Park) into R (Reverse) unless the brake pedal is depressed.

To shift the transmission from P (Park) into R (Reverse):

1. Depress and hold the brake pedal.
2. Start the engine or turn the ignition switch to the ON position.
3. Move the shift lever.

If the shift lever does not move even after performing this procedure, have the system checked by authorized Kia dealer.

If the brake pedal is repeatedly depressed and released with the shift lever in the P (Park) position, a chattering noise & vibration near the shift lever may be heard. This is a normal condition.

### **⚠ WARNING**

#### **Shifting from P (Park)**

Always fully depress the brake pedal before and while shifting out of the P (Park) position into another position to avoid inadvertent motion of the vehicle which could injure persons in or around the vehicle.

## Shift-lock override

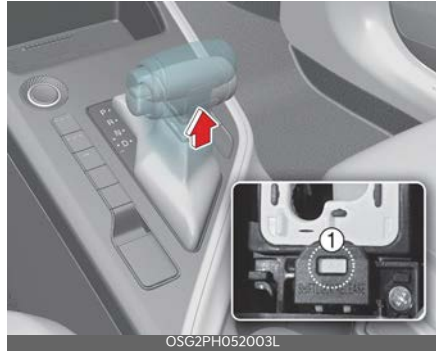

If the shift lever cannot be moved from the P (Park) position into R (Reverse) position with the brake pedal depressed, continue depressing the brake, and then do the following:

1. Place the ignition switch or ENGINE START/STOP button in the LOCK/OFF position.
2. Apply the parking brake.
3. Carefully remove the knob boots covering the shift-lock release access hole (1).
4. Insert a tool (e.g., flathead screwdriver) into the access hole and press down on the tool.
5. Move the shift lever.
6. Remove the tool from the shift - lock override access hole then install the knob boots.

If the shift lever does not move even after performing this procedure, have the system inspected by an authorized Kia dealer.

## Good driving practices

- Never move the shift lever from P (Park) or N (Neutral) to any other position with the accelerator pedal depressed.



- Never move the shift lever into P (Park) when the vehicle is in motion.
- Be sure the car is completely stopped before you attempt to shift into R (Reverse) or D (Drive).
- Never take the car out of gear and coast down a hill. This may be extremely hazardous. Always leave the car in gear when moving.
- Do not "ride" the brakes. This can cause them to overheat and malfunction. Instead, when you are driving down a long hill, slow down and shift to a lower gear. When you do this, engine braking will help slow the car.
- Slow down before shifting to a lower gear. Otherwise, the lower gear may not be engaged.
- Always use the parking brake. Do not depend on placing the transmission in P (Park) to keep the car from moving.
- Exercise extreme caution when driving on a slippery surface. Be especially careful when braking, accelerating or shifting gears. On a slippery surface, an abrupt change in vehicle speed can cause the drive wheels to lose traction and the vehicle to go out of control.
- Optimum vehicle performance and economy is obtained by smoothly depressing and releasing the accelerator pedal.

### WARNING

- When driving uphill or downhill, always shift to D (Drive) for driving forward or shift to R (Reverse) for driving backwards, and check the gear position indicated on the cluster before driving.

Driving in the opposite direction of the selected gear can lead to a dangerous

situation by shutting off the engine and affecting the braking performance.

- Always buckle-up! In a collision, an unbelted occupant is significantly more likely to be seriously injured or killed than a properly belted occupant.
- Avoid high speeds when cornering or turning.
- Do not make quick steering wheel movements, such as sharp lane changes or fast, sharp turns.
- The risk of rollover is greatly increased if you lose control of your vehicle at highway speeds.
- Loss of control often occurs if two or more wheels drop off the roadway and the driver oversteers to reenter the roadway.
- In the event your vehicle leaves the roadway, do not steer sharply. Instead, slow down before pulling back into the travel lanes.
- Never exceed posted speed limits.

### WARNING

If your vehicle becomes stuck in snow, mud, sand, etc., then you may attempt to rock the vehicle free by moving it forward and backward. Do not attempt this procedure if people or objects are anywhere near the vehicle. During the rocking operation the vehicle may suddenly move forward or backward as it becomes unstuck, causing injury or damage to nearby people or objects.

## Dual clutch transmission (DCT) (Dial SBW) (if equipped)



Select transmission positions by turning the dial SBW.

### Dual clutch transmission operation

The dual clutch transmission has 6 forward speeds and one reverse speed.

The individual speeds are selected automatically, depending on the balance between the fuel economy and the power.

- The dual clutch transmission can be thought of as an automatically shifting manual transmission. It gives the driving feel of a manual transmission, yet provides the ease of a fully automatic transmission.
- When D (Drive) is selected, the transmission will automatically shift through the gears similar to a conventional automatic transmission. Unlike a traditional automatic transmission, the gear shifting can sometimes be felt and heard as the actuators engage the clutches and the gears are selected.
- The dual clutch transmission incorporates a dry-type dual clutch mechanism, which allows for better acceleration performance and increased fuel efficiency while driving. But it differs from a conventional automatic transmission because it does not incorporate a torque converter. Instead, the transition from one gear to the next is managed by the clutch slip, especially at lower speeds.
- As a result, shifts are sometimes more noticeable, and a light vibration can be felt as the transmission shaft speed is matched with the engine shaft speed.
- The dry-type clutch transfers torque more directly and provides a direct-drive feeling which may feel different from a conventional automatic transmission. This may be more noticeable when launching the vehicle from a stop or when traveling at low, stop-and-go vehicle speeds.
- When rapidly accelerating from a lower vehicle speed, the engine RPM may increase dramatically as a result of the clutch slip as the dual clutch transmission selects the correct gear. This is a normal condition.
- When accelerating from a stop on an incline, press the accelerator smoothly and gradually to avoid any shudder feeling or jerkiness.
- When traveling at a lower vehicle speed, if you release the accelerator pedal quickly, you may feel engine braking before the transmission changes gears. This engine braking feeling is similar to operating a manual transmission at low speed.
- When driving downhill, you may downshift to a lower gear in order to control your speed without using the brake pedal excessively.
- When you turn the engine on and off, you may hear clicking sounds as the system goes through a selftest. This is a normal sound for the dual clutch transmission.

- During the first 1,500 km (1000 miles), you may feel that the vehicle may not be smooth when accelerating at low speed. During this break-in period, the shift quality and performance of your new vehicle is continuously optimized.

### **⚠ WARNING**

To reduce the risk of serious injury or death:

- ALWAYS check the surrounding areas near your vehicle for people, especially children, before shifting a vehicle into D (Drive) or R (Reverse).
- Before leaving the driver's seat, always make sure the shifter dial is in the P (Park) position, then set the parking brake, and place the vehicle in the LOCK/OFF position. Unexpected and sudden vehicle movement can occur if these precautions are not followed.
- Do not use aggressive engine braking (shifting from a higher gear to a lower gear) on slippery roads. This could cause the tires to slip and may result in an accident.

### **\* NOTICE**

- Always come to a complete stop before shifting into D (Drive) or R (Reverse).
- Do not put the gear in N (Neutral) while driving.

### **⚠ WARNING**

- If the transmission cannot shift into Drive or Reverse, the position indicator D or R) on the cluster will blink. Have the system checked by an authorized Kia dealer.

## DCT warning messages

### Steep grade

This warning message is displayed when vehicle is driven slowly on a grade and the vehicle detects that the brake pedal is not applied.

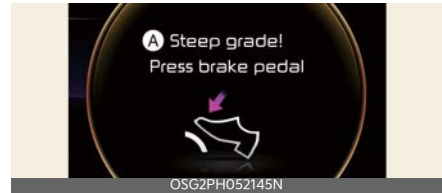

### A: Steep grade! Press brake pedal

Driving up hills or on steep grades:

- To hold the vehicle on an incline use the foot brake or the parking brake.
- When in stop-and-go traffic on an incline, keep some distance ahead before moving the vehicle forward. Then hold the vehicle on the incline with the foot brake.
- If the vehicle is held on a hill by applying the accelerator pedal or by creeping with brake pedal disengaged, the clutch and transmission may overheat which can result in damage. At this time, a warning message will appear on the LCD display.
- If the LCD warning is active, the foot brake must be applied.
- Ignoring the warnings can lead to damage to the transmission.

## Transmission high temperature



### A: Transmission temp. is high! Stop safely

- Under certain conditions, such as repeated stop-and-go launches on steep grades, sudden take off or acceleration, or other harsh driving conditions, the transmission clutch temperatures will increase excessively. Finally the clutch in transmission could be overheated.
- When the clutch is overheated, the safe protection mode engages and the gear position indicator on the cluster blinks with a chime. At this time, "Transmission temp. is high! Stop safely" warning message will appear on the LCD display and driving may not be smooth.
- If this occurs, pull over to a safe location, stop the vehicle with the engine running, apply the parking brake after shifting the vehicle to N (Neutral) with the brake pedal depressed, and allow the transmission to cool.
- If you ignore this warning, the driving condition may become worse. You may experience abrupt shifts, frequent shifts, or jerkiness. To return to the normal driving condition, stop the vehicle and apply the foot brake or shift into P (Park).  
Then allow the transmission to cool for a few minutes with engine on, before driving off.

- When possible, drive the vehicle smoothly.

## Transmission overheated



### A: Transmission Hot! Park with engine on

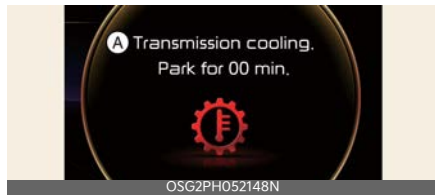

### A: Transmission cooling. Park for 00 min.

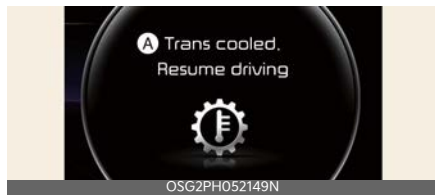

### A: Trans cooled. Resume driving

- If the vehicle continues to be driven and the clutch temperatures reach the maximum temperature limit, the "Transmission hot! Park with engine On" warning will be displayed. When this occurs the clutch is disabled until the clutch cools to normal temperatures.
- The warning will display a time to wait for the transmission to cool.
- If this occurs, pull over to a safe location, stop the vehicle with the engine running, apply the brakes and shift

the vehicle to P (Park), and allow the transmission to cool.

- When the message "Transmission cooled down. Resume driving" appears you can continue to drive your vehicle.
- When possible, drive the vehicle smoothly.

If any of the warning messages in the LCD display continue to blink, for your safety, have the system checked by an authorized Kia dealer.

### Transmission ranges



The indicator in the instrument cluster displays the transmission position when the vehicle is in the ON position.

### P (Park)

To shift the gear from R (Reverse), N (Neutral) or D (Drive) to P (Park), press the [P] button.

If you turn off the vehicle in D (Drive), N (Neutral) or R (Reverse), the gear automatically shifts to P (Park).

If you have done all of the above and still cannot shift out of P (Park), see "Shift-lock system" on page 6-29.

If you turn off the vehicle in D (Drive), N (Neutral) or R (Reverse), the gear automatically shifts to P (Park).

With the vehicle on, the gear automatically shifts to P (Park) if you open the driver's door when the gear is in N (Neutral), R (Reverse) or D (Drive) and the following conditions are met:

- The brake/accelerator pedal is not depressed.
- The seat belt is unfastened.
- The vehicle speed is below 2 km/h (1 mph). When the vehicle is over a certain speed, the gear does not shift to P (Park) when the P button is pressed.

### ⚠ WARNING

- Shifting into P (Park) while the vehicle is in motion may cause you to lose control of the vehicle.
- After the vehicle has stopped, always make sure the gear is in P (Park), apply the parking brake, and turn the engine off.
- When parking on an incline, block the wheels to prevent the vehicle from rolling down.
- For safety, always engage the parking brake with the shifter dial in the P (Park) position except for the case of emergency parking.

### R (Reverse)

Use this position to drive the vehicle backward.

To shift to R (Reverse), turn the dial SBW to the R (Reverse) position while depressing the brake pedal.

**⚠ CAUTION**

Always come to a complete stop before shifting into or out of R (Reverse); you may damage the transmission if you shift into R (Reverse) while the vehicle is in motion.

**N (Neutral)**

The wheels and transmission are not engaged.

To shift to N (Neutral), turn the dial SBW to the N (Neutral) position while depressing the brake pedal.

Always depress the brake pedal when you are shifting from N (Neutral) to another gear.

In N (Neutral), if the driver attempts to turn off the vehicle, the vehicle is turned OFF and shifted to the P (Park) position automatically.

**⚠ WARNING**

Do not shift into gear unless your foot is firmly on the brake pedal. Shifting into gear when the engine is running at high speed can cause the vehicle to move very rapidly. You could lose control of the vehicle and hit people or objects.

**⚠ WARNING**

Do not drive with the shifter dial in N (Neutral).

The engine brake will not work and lead to an accident.

**D (Drive)**

This is the normal driving position. To shift to D (Drive), move the dial SBW to the D (Drive) position while depressing the brake pedal.

In D (Drive), if the driver attempts to turn off the vehicle, the vehicle is turned OFF and shifted to the P (Park) position automatically.

**Stay in N (Neutral) position when vehicle is Off**

If you want to keep the N (Neutral) position after the vehicle is OFF, do the following.



1. Deactivate the AUTO HOLD and release the parking brake when the ENGINE START/STOP button is ON.
2. Turn the dial SBW to the N (Neutral) position by depressing the brake pedal. If the message ("Press and hold OK button to stay in Neutral when vehicle is Off") appears on the cluster LCD display, press and hold the OK button on the steering wheel for more than 1 second. After the message is disappeared, the vehicle cannot keep the N position when the vehicle is off.
3. Turn off the engine after the message ("Vehicle will stay in (N). Change gear to cancel") appears on the cluster LCD display.

In this situation, if you unfasten the driver's seat belt and open the driver's door within 3 minutes, the gear shifts to P (Park) position and the ENGINE START/STOP button is turned off.

**When the battery is discharged:**

You cannot shift the shift dial, when the battery is discharged.

In emergencies, do the following to move the shift dial to N (Neutral) on a level ground.

1. Connect the battery cables from another vehicle or from another battery to the jump-starting terminals inside the engine compartment. For more details, refer to "Emergency starting" on page 7-5.
2. Release the parking brake with the ENGINE START/STOP button in the ON position.
3. Shift the gear to the N (Neutral) position. If you want to keep the N position after the vehicle is off, disconnect the battery from vehicle or refer to "Stay in N (Neutral) position when vehicle is Off" on page 6-26.

### **CAUTION**

- Always park the vehicle in P (Park) for safety and engage the parking brake. If left in N, the vehicle may move and cause serious damage and injury.
- After the ENGINE START/STOP button has been turned off, the electronic parking brake cannot be disengaged.
- For EPB (Electronic Parking Brake) equipped vehicles with AUTO HOLD function used while driving, if the ignition button has been turned "OFF", the electronic parking brake will be engaged automatically. Therefore, AUTO HOLD function should be turned off before the ignition button is turned off.

### LCD display messages

If a message appears on the LCD display, refer to the next section for the appropriate steps to take.

### Shifting conditions not met

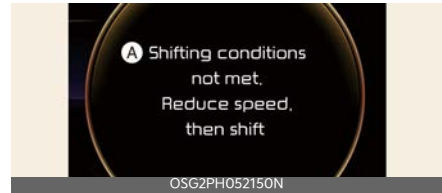

#### **A: Shifting conditions not met. Reduce speed, then shift**

The message appears on the LCD display in the following conditions:

- When driving speed is too fast to shift the gear. Decrease the vehicle speed or slow down before shifting the gear.

### Press brake pedal to change gear

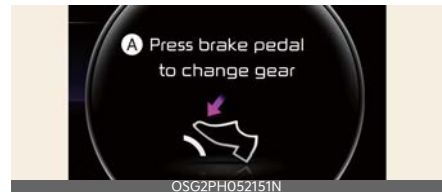

#### **A: Press brake pedal to change gear**

The message appears on the LCD display, when the brake pedal is not depressed while shifting the gear.

Depress the brake pedal and then shift the gear.

### Shift to P after stopping



#### **A: Shift to P after stopping**

The message appears on the LCD display when the gear is shifted to P (Park) while the vehicle is moving.

Stop the vehicle before shifting to P (Park).

### Gear already selected



#### A: Gear already selected

The message appears on the LCD display when the P gear button is selected again or the gear is overheated.

### PARK malfunction. Engage parking brake when parking vehicle

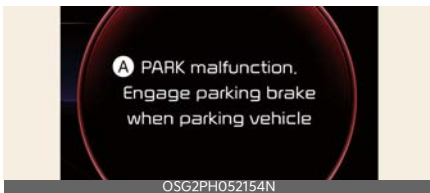

#### A: PARK malfunction. Engage parking brake when parking vehicle

The message is displayed when there is a problem with function engaging P (Park) position.

Have the system inspected by an authorized Kia dealer.

### Check P button

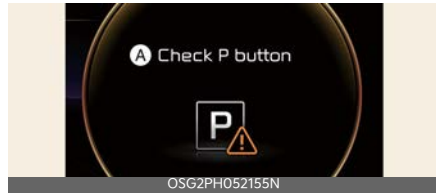

#### A: Check P button

The message appears on the LCD display when there is problem with the P button.

Immediately have the vehicle inspected by an authorized Kia dealer.

### Check shifter dial

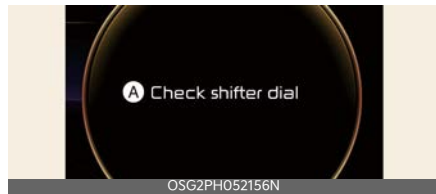

#### A: Check shifter dial

The message appears on the LCD display when there is problem with the dial SBW.

Immediately have the vehicle inspected by an authorized Kia dealer

### Rotary shifter stuck

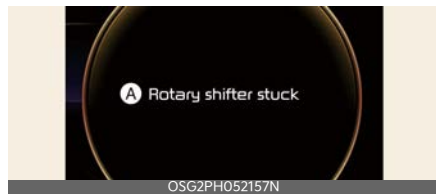

#### A: Rotary shifter stuck

The message appears on the LCD display when the dial SBW is continuously



stuck or there is problem with the dial SBW.

Make sure that there is no object around the dial SBW. If the problem persists, immediately have the vehicle inspected by an authorized Kia dealer.

### Shift-lock system

For your safety, your vehicle has a shift-lock system which prevents shifting the gear from P (Park) or N (Neutral) into R (Reverse) or D (Drive) unless the brake pedal is depressed.

To shift from P (Park) or N (Neutral) into R (Reverse) or D (Drive), from R (Reverse) into D (Drive) or from D (Drive) into R (Reverse):

1. Depress and hold the brake pedal.
2. Start the vehicle or place the ENGINE START/STOP button in the ON position.
3. Turn the dial SBW to the R (Reverse) or D (Drive) position.

### Good driving practices

- Never move the gear from P (Park) or N (Neutral) to any other position with the accelerator pedal depressed.
- Never move the gear into P (Park) when the vehicle is in motion.
- Be sure the vehicle is completely stopped before you attempt to shift into R (Reverse) or D (Drive).
- Never take the vehicle out of gear and coast down a hill. This may be extremely hazardous. Always leave the vehicle in gear when moving.
- Do not "ride" the brakes. This can cause them to overheat and malfunction. Instead, when you are driving down a long hill, slow down and shift to a lower gear. When you do this,

engine braking will help slow the vehicle.

- Slow down before shifting to a lower gear. Otherwise, the lower gear may not be engaged.
- Always use the parking brake. Do not depend on placing the transmission in P (Park) to keep the vehicle from moving.
- Exercise extreme caution when driving on a slippery surface. Be especially careful when braking, accelerating or shifting gears. On a slippery surface, an abrupt change in vehicle speed can cause the drive wheels to lose traction and the vehicle to go out of control.
- Optimum vehicle performance and economy is obtained by smoothly depressing and releasing the accelerator pedal.

### WARNING

- When driving uphill or downhill, always shift to D (Drive) for driving forward or shift to R (Reverse) for driving backwards, and check the gear position indicated on the cluster before driving. Driving in the opposite direction of the selected gear can lead to a dangerous situation by shutting off the engine and affecting the braking performance.
- Always buckle-up! In a collision, an unbelted occupant is significantly more likely to be seriously injured or killed than a properly belted occupant.
- Avoid high speeds when cornering or turning.
- Do not make quick steering wheel movements, such as sharp lane changes or fast, sharp turns.

- The risk of rollover is greatly increased if you lose control of your vehicle at highway speeds.
- Loss of control often occurs if two or more wheels drop off the roadway and the driver oversteers to reenter the roadway.
- In the event your vehicle leaves the roadway, do not steer sharply. Instead, slow down before pulling back into the travel lanes.
- Never exceed posted speed limits.

### **⚠ WARNING**

If your vehicle becomes stuck in snow, mud, sand, etc., then you may attempt to rock the vehicle free by moving it forward and backward. Do not attempt this procedure if people or objects are anywhere near the vehicle. During the rocking operation the vehicle may suddenly move forward or backward as it becomes unstuck, causing injury or damage to nearby people or objects.

### ***Moving up a steep grade from a standing start***

To move up a steep grade from a standing start, depress the brake pedal:

- Shift the shift lever to D (Drive).  
Select the appropriate gear depending on load weight and steepness of the grade, and release the parking brake. Depress the accelerator gradually after releasing the brake pedal.

## **Paddle shifter**

### **Manual mode**

Paddle shifter is used to shift without taking your hands off the steering wheel.



### **Operation**

- Pull the right side (+) of the paddle shifter once to shift up.
- Pull the left side (-) of the paddle shifter once to shift down.

### **Operating condition(s)**

- The shift lever is in manual mode. (if equipped)
- The vehicle is in D (Drive) and SPORT mode.

### **⚠ CAUTION**

- If you pull the left and right side of the paddle shifters at the same time, you cannot shift the gear.
- Sudden engine brakes and rapid acceleration could cause malfunction. Shift appropriately according to road conditions and driving speed.

### \* NOTICE

- The vehicle will shift to manual to automatic shift mode in following conditions:
  - When the vehicle speed decreases below 3 km/h (2 mph).
  - When the accelerator pedal is gently depressed for more than 6 seconds while driving.

## Regenerative braking mode



### Operation

- Pull the left side (-) of the paddle shifter to increase regenerative braking and deceleration.  
Pull and hold the left side (-) of the paddle shifter to reach MAX and stop the vehicle.
- Pull the right side (+) of the paddle shifter to decrease regenerative braking and deceleration.

Pull and hold the right side (+) of the paddle shifter to turn on or off smart regeneration system.

### ⚠ CAUTION

- The initial setting will be set to 0 when the vehicle is in D (Drive) and in ECO mode.
- If the vehicle changes to P (Park), R (Reverse), N (Neutral) or manual mode (shift lever), or vehicle is in SPORT mode, the vehicle regenerative braking system control will not be operated. Resetting the vehicle in D (Drive) will set the regenerative system setting to 0.
- ABS and ESC will deactivate the regenerative system.
- Even if the setting for regenerative braking system is identical, it might feel different due to various vehicle speeds. (the higher speed, the less deceleration feeling)
- The regenerative braking system can be controlled
  - when the vehicle is stop in D (Drive)
  - when you are not depressing brake pedal, and the vehicle is above 2 km/h (1 mph)

### \* NOTICE

Regenerative braking uses motor's power to conserve energy to the high-voltage battery when braking to gain more fuel economy and higher efficiency.

## Battery charged, Regenerative braking mode deactivated



### A: Regeneration unavailable. Battery full

The message will appear when the high-voltage battery amount is charged enough.

## Regenerative braking mode by paddle shifter not activated

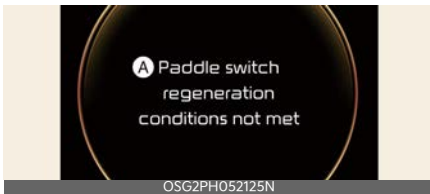

### A: Paddle switch regeneration conditions not met

The message will appear when:

- When the battery is in high or low temperature
- When the battery or transmission is not functioning properly
- Regenerative braking mode is activated while ABS/Cruise Control/Smart Cruise Control is operating

Drive normally and use the function again to dismiss the message.

## Vehicle stop function (MAX setting)

### Operation

- Pull and hold the left side (-) of the paddle shifter to stop the vehicle.
- The instrument cluster indicator will set to MAX when the vehicle is braking.
- The instrument cluster indicator will set to STOP when the vehicle is stopped.
- The left side (-) of the paddle shifter should be pulled while driving.
- If the vehicle is stopped, the vehicle will retain its position when the left side (-) of the paddle shifter is not pulled.
- Depress the accelerator pedal to move the vehicle in STOP position.
- Depressing the brake pedal in MAX position will retain its settings regardless of paddle shifter operation. (The vehicle will set to STOP position when the vehicle is stopped.)

### **⚠ CAUTION**

- The function does not control the distance between vehicles.
- The vehicle may not stop properly on steep hills. Depress the brake to stop the vehicle.

## Smart regeneration system

The Smart Regeneration System controls the regenerative braking automatically according to the road gradient and driving condition of the vehicle in front.

The system minimizes the unnecessary operation of the brake and acceleration pedal, improving the electric efficiency and assisting the driver.

## Setting smart regeneration system

### Operation

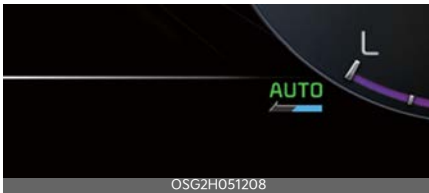

- With the vehicle on, touch **Settings** → **Vehicle** → **Eco Vehicle** → **Smart Recuperation** on the infotainment system or pull and hold the right side paddle shifter for over 1 second to turn on and off the automatic change of the regenerative braking.

The level of regenerative braking displayed on the cluster in stages is converted to the 'AUTO' indicator light.

- When the vehicle is turned off and then turned on again, the regenerative braking mode returns to step 'O'.

### \* INFORMATION

The infotainment system may change after software updates. For more information, refer to the user's manual provided in the infotainment system and the quick reference guide.

## Smart regeneration system activation

With 'AUTO' for the regenerative braking level displayed on the cluster, the regenerative braking level is controlled automatically when vehicle speed is above 12 km/h (7.4 mph) and one of the condition below is met.

- The road gradient changes
- Distance from the vehicle ahead reduces or increases
- Speed of the vehicle ahead reduces or increases

### \* NOTICE

When vehicle speed is under 12 km/h (7.4 mph), the Smart Regeneration System is canceled. The driver must adjust the vehicle speed by depressing the accelerator or brake pedal according to the road condition ahead and driving condition.

When the system is turned on from the Vehicle Settings menu, but the front radar does not recognize the vehicle in front, 'AUTO' is displayed in white.

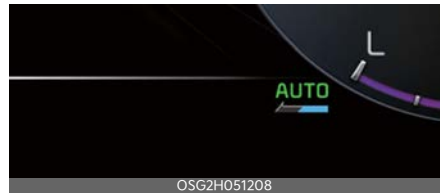

If the front radar recognizes the vehicle in front, 'AUTO' is displayed in green. The regenerative braking level is automatically controlled depending on the driving condition of the vehicle in front and the level is indicated with arrows.

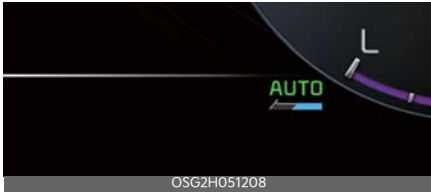

However, current regenerative braking level is maintained if the driver depresses the brake pedal while the system is in activation. Also, the system is canceled temporarily if the accelerator pedal is depressed.

**⚠ WARNING**

The Smart Regeneration System which automatically controls the regenerative braking level when coasting is only a supplemental system for the driver's convenience. Do not solely rely on this system to stop the vehicle. **The system cannot completely stop the vehicle in all situations nor avoid all collisions.** The brake control may be insufficient depending on the speed of the vehicle in front and when the vehicle in front suddenly stops, a vehicle cuts in suddenly or there is a steep slope. Always look ahead cautiously to prevent unexpected and sudden situations from occurring.

**Smart regeneration system will be temporarily canceled when:**

- Canceled manually  
 With the vehicle on, touch **Settings** → **Vehicle** → **Eco Vehicle** → **Smart Recuperation** on the infotainment system or pull and hold the right side paddle shifter for over 1 second.  
 The Smart Regeneration System turns off and switches to the regenerative braking level indicator with arrows instead of 'AUTO' indicator.

- Canceled automatically
  - The vehicle is shifted to N (Neutral), R (Reverse) or P (Park) or shift lever in manual mode.
  - Switch the DRIVE mode to SPORT mode.
  - Smart Cruise Control is in activation.
  - The ESC (Electronic Stability Control) or ABS is operating.
  - When the motor and battery are in high or low temperature, or there is a problem with the battery or transmission.
  - SOC (State of Charge) gauge indicates high level.

**⚠ WARNING**

When the Smart Regeneration System is canceled automatically, adjust the vehicle speed directly by depressing the accelerator or brake pedal according to the road and driving conditions ahead.

**\* INFORMATION**

The infotainment system may change after software updates. For more information, refer to the user's manual provided in the infotainment system and the quick reference guide.

**Resuming smart regeneration system**

To re-activate the Smart Regeneration System while driving, with the vehicle on, touch **Settings** → **Vehicle** → **Eco Vehicle** → **Smart Recuperation** on the infotainment system or pull and hold the right side paddle shifter for over 1 second.  
 Then AUTO for the regenerative braking level will appear on the cluster.

## \* INFORMATION

The infotainment system may change after software updates. For more information, refer to the user's manual provided in the infotainment system and the quick reference guide.

### Basic setting of smart regeneration system

With the Smart Regeneration System ON, Pull and hold the right side of the paddle shifter for more than 1 second to set the regenerative braking level.

The automatic regenerative braking step adjustment by the smart regenerative system operates in steps beyond the set basic step.

### Vehicle-to-vehicle distance recognition sensor

In order for the Smart Regeneration System to operate properly, always make sure the radar sensor cover is clean and free of dirt, snow, and debris.

Dirt, snow, or foreign substances on the lens may adversely affect the sensing performance of the sensor. In this case, the system operation may stop temporarily and not operate normally.

Front radar



OSG2H051022

## ⚠ CAUTION

- Do not apply license plate frame or foreign objects such as a bumper sticker or a bumper guard near the radar sensor. Doing so may adversely

affect the sensing performance of the radar.

- Always keep the radar sensor and lens cover clean and free of dirt and debris.
- Use only a soft cloth to wash the vehicle. Do not spray pressurized water directly on the sensor or sensor cover.
- Be careful not to apply unnecessary force on the radar sensor or sensor cover. If the sensor is forcibly moved out of proper alignment, the Smart Regeneration System may not operate correctly. In this case, a warning message may not be displayed. Have the vehicle inspected by an authorized Kia dealer.
- If the front bumper becomes damaged in the area around the radar sensor, the Smart Regeneration System may not operate properly. Have the vehicle inspected by an authorized Kia dealer.
- Use only genuine parts or those of an equivalent standard to repair or replace a damaged sensor or sensor cover. Do not apply paint to the sensor cover.

### System malfunction

The following message will appear when the Smart Regeneration System is not functioning normally.



OSG2PH052037N

**A: Check Smart Regeneration System**

The message will appear when the system is not functioning normally. The system will be canceled and the word 'AUTO' on the cluster will disappear and instead display regenerative braking level. Check for foreign substances on the front radar. Remove any dirt, snow, or foreign material that could interfere with the radar sensors. If the system still does not operate normally, take your vehicle to an authorized Kia dealer and have the system checked.

### Limitations of the system

The Smart Regeneration System may not operate properly in certain situations when the driving condition is beyond the performance of the front radar sensor. Driver's attention is required in such cases when the system does not react properly or operate unintentionally.

### Driving on a curved road



When driving on the curve, the system may not detect the vehicle in your lane and the regenerative braking level will reduce automatically, making you feel that the vehicle is accelerating. Also, if the system suddenly recognizes the vehicle in front, the regenerative braking level will increase automatically, making you feel that the vehicle is decelerating. The driver must maintain a safe braking distance, and if necessary, depress the brake pedal to reduce your driving

speed in order to maintain a safe distance.



The smart regeneration system may recognize a vehicle in an adjacent lane when driving on a curved road. In this case, the system increase the braking level and slow the vehicle.

Always pay attention to road and driving conditions while driving. If necessary, depress the brake pedal to reduce your driving speed in order to maintain a safe distance. Also, when necessary, you may depress the accelerator pedal to prevent the system from unnecessarily decelerating your vehicle.

Always check the traffic conditions around the vehicle.

### Driving on a sloped road



When driving uphill or downhill, the system may not detect the vehicle in your lane and the regenerative braking level will reduce automatically, making you feel that the vehicle is accelerating. Also, if the system suddenly recognizes the vehicle in front, the regenerative braking level will increase automatically, making you feel that the vehicle is decelerating.



The driver must maintain a safe braking distance, and if necessary, depress the brake pedal to reduce your driving speed in order to maintain a safe distance.

## Changing lanes

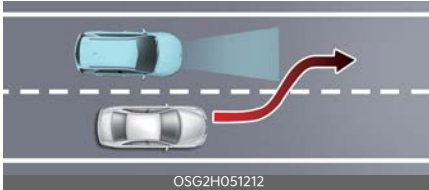

When a vehicle changes lanes in front of you, the smart regeneration system may not immediately detect the vehicle, especially if the vehicle changes lanes abruptly. In this case, you must maintain a safe braking distance, and if necessary, depress the brake pedal to reduce your driving speed in order to maintain a safe distance.

## Recognizing the vehicle



Some vehicles in your lane cannot be recognized by the sensor:

- Narrow vehicles such as motorcycles or bicycles
  - Vehicles offset to one side
  - Slow-moving vehicles or sudden-decelerating vehicles
  - Stopped vehicles (When the vehicle ahead drives away, the system may not detect a stopped vehicle.)
  - Vehicles with small rear profile such as trailers with no loads
- A vehicle ahead cannot be recognized correctly by the sensor if any of following occurs:
- When the vehicle is pointing upwards due to overloading in the luggage compartment
  - While the steering wheel is operating
  - When driving to one side of the lane
  - When driving on narrow lanes or on curves
- Apply the brake or accelerator pedal if necessary.

### **⚠ WARNING**

When using the Smart Regeneration System take the following precautions:

- If an emergency stop is necessary, you must apply the brakes.
- Keep a safe distance according to road conditions and vehicle speed. If the vehicle distance is too close during high-speed driving, a serious collision may result.
- Always maintain sufficient braking distance and decelerate your vehicle by applying the brakes if necessary.
- The Smart Regeneration System is designed to detect and monitor the vehicle ahead in the roadway through radar signals. It is not designed to detect oncoming vehicles, pedestrians, bicycles, motorcycles, or smaller wheeled objects such as luggage bags, shopping carts, or strollers.
- Vehicles moving in front of you with a frequent lane change may cause a delay in the system's reaction or may cause the system to react to a vehicle actually in an adjacent lane. Always drive cautiously to prevent unex-

pected and sudden situations from occurring.

- The Smart Regeneration System may not recognize complex driving situations so always pay attention to driving conditions and control your vehicle speed.

### \* NOTICE

The Smart Regeneration System may not operate temporarily due to:

- Electrical interference
- Modifying the suspension
- Differences of tire abrasion or tire pressure
- Installing different type of tires

## Brake system

Your vehicle has power-assisted brakes, parking brake, and various braking systems for safe driving.

### Power brakes

Your vehicle has power-assisted brakes that adjust automatically through normal usage.

In the event that the power-assisted brakes lose power because of a stalled engine or some other reason, you can still stop your vehicle by applying greater force to the brake pedal than you normally would. The stopping distance, however, will be longer.

When the engine is not running, the reserve brake power is partially depleted each time the brake pedal is applied. Do not pump the brake pedal when the power assist has been interrupted.

Pump the brake pedal only when necessary to maintain steering control on slippery surfaces.

### \* NOTICE

- When stepping on the brake pedal under a certain driving or weather condition, you may witness your car make a sound of squealing or some other noises. This is not a brake malfunction but a normal phenomenon.
- When driving on the road to which deicing chemicals are applied, the vehicle may witness noises from the brake or abnormal abrasion of tires because of such deicing chemicals. You should operate brake additionally so that you would be able to remove the deicing chemicals on the brake disk and pad under a safe traffic condition.

**⚠ CAUTION****Brake pedal**

Do not drive with your foot resting on the brake pedal. This will create abnormally high brake temperatures which can cause excessive brake lining and pad wear.

**⚠ WARNING****HEV driving down hill**

Do not turn off the vehicle while going down a hill. The brake booster may not work sufficiently and the braking distance may be longer.

**⚠ WARNING****Steep hill braking**

Avoid continuous application of the brakes when descending a long or steep hill by shifting to a lower gear. Continuous brake application will cause the brakes to overheat and could result in a temporary loss of braking performance.

Wet brakes may impair the vehicle's ability to safely slow down; the vehicle may also pull to one side when the brakes are applied. Applying the brakes lightly will indicate whether they have been affected in this way. Always test your brakes in this fashion after driving through deep water. To dry the brakes, apply them lightly while maintaining a safe forward speed until brake performance returns to normal.

**In the event of brake failure**

If service brakes fail to operate while the vehicle is in motion, you can make an emergency stop with the parking brake. The stopping distance, however, will be much greater than normal.

**⚠ WARNING****Parking brake**

Avoid applying the parking brake to stop the vehicle while it is moving except in an emergency situation. Applying the parking brake while the vehicle is moving at normal speeds can cause a sudden loss of control of the vehicle. If you must use the parking brake to stop the vehicle, use great caution in applying the brake.

**Brake Over Accelerator**

In the event the accelerator pedal becomes stuck or entrapped, apply steady and firm pressure to the brake pedal to slow the vehicle and reduce engine power.

If you experience this condition, take the following steps:

1. Apply the brakes and bring your vehicle to a safe stop.
2. Move the transmission to P (Park), switch the engine off and apply the parking brake.
3. Inspect the accelerator pedal for any interference.

If none are found and the condition persists, have your vehicle towed to an authorized Kia dealer.

**Disc brakes wear indicator**

When your brake pads are worn and new pads are required, you will hear a high-pitched warning sound from your front brakes or rear brakes. You may hear this sound come and go or it may occur whenever you press the brake pedal.

Always replace the front or rear brake pads as pairs.

**⚠ CAUTION****Replace brake pads**

Do not continue to drive with worn brake pads. Continuing to drive with worn brake pads can damage the braking system and result in costly brake repairs.

**⚠ WARNING****Brake wear**

Do not ignore high pitched wear sounds from your brakes. If you ignore this audible warning, you will eventually lose braking performance, which could lead to a serious accident.

**\* NOTICE**

Brake dust may accumulate on the wheels, even under normal driving conditions. Some dust is inevitable as the brakes wear and contribute to brake noise.

**Electronic Parking Brake (EPB)**

After parking the vehicle, apply the Electronic Parking Brake (EPB) to prevent the vehicle from being moved by the external force.

**Applying the parking brake****Applying the parking brake with EPB switch**

1. Depress the brake pedal.
2. Pull up the EPB switch.

Make sure the warning light comes on.

Also, the EPB is applied automatically if the Auto Hold button is on when the vehicle is turned off. In addition, if you pull up the EPB switch after the vehicle is turned off, the EPB will be applied.

**⚠ WARNING**

Never leave children and animals unattended in the vehicle. If you leave children unaccompanied in the vehicle, they may be able to set the vehicle in motion, for example by:

- Releasing the parking brake.
- Shifting the transmission out of P (Park) position.
- Starting the engine.

In addition, they may operate vehicle equipment.

**\* NOTICE**

On a steep incline or when pulling a trailer, if the vehicle does not remain at a standstill, do as follows:

1. Apply the EPB.
2. Pull up the EPB switch for more than 3 seconds.

Do not operate the EPB while the vehicle is moving except in an emergency situation.

**\* NOTICE**

A click or electric brake motor whine sound may be heard while operating or releasing the EPB.

These conditions are normal and indicate that the EPB is functioning properly.

## Automatic application of EPB

The EPB is applied automatically under following conditions.

- Engine OFF while AUTO HOLD is enabled
- Conditions below while AUTO HOLD is activated
  - Driver's door is opened
  - Hood is opened
  - Liftgate is opened
  - Vehicle stops for more than approximately 10 minutes
  - Vehicle stops on a steep slope
- Requested by other systems

### \* NOTICE

For Electronic Parking Brake (EPB) equipped vehicles with AUTO HOLD function used while driving, if the ENGINE START/STOP button has been turned OFF, the EPB will be engaged automatically. Therefore, AUTO HOLD function should be turned off before the ENGINE START/STOP button is turned off.

## Emergency braking with the EPB switch

If there is a problem with the brake pedal while driving, emergency braking is possible by pulling up and holding the EPB switch.

Braking is possible only while you are holding the EPB switch.

### ⚠ WARNING

Do not operate the Electronic Parking Brake (EPB) while the vehicle is moving except in an emergency situation. Applying the EPB while the vehicle is moving at normal speeds can cause a sudden loss of control of the vehicle. If you must

use the EPB to stop the vehicle, use great caution in applying the brake.

### \* NOTICE

During emergency braking by the EPB, the parking brake warning light will appear to indicate that the system is operating.

If you notice a continuous noise or burning smell when the EPB is used for emergency braking, have your vehicle checked by an authorized Kia dealer.

## Releasing the parking brake with EPB switch



Releasing the parking brake with EPB switch,

1. Have the ENGINE START/STOP button in the ON position.
2. Press the brake pedal.
3. Press the EPB switch.
4. Make sure the brake warning light goes off.

## Automatic release of EPB

The EPB is released automatically under following conditions.

- Gear in P (Park)
  - With the engine running, engage the brake pedal and shift out of P (Park) to R (Reverse) or D (Drive).
- Gear in N (Neutral)
  - With the engine running, engage the brake pedal and shift out of N (Neutral) to R (Reverse) or D (Drive).

Make sure the brake warning light goes off.

### \* NOTICE

- For your safety, you can engage the EPB even though the ENGINE START/STOP button is in the OFF position, but you cannot release it.
- For your safety, press the brake pedal and release the parking brake manually with the EPB switch when you drive downhill or when backing up the vehicle.

Do not follow the above procedure when driving on a flat level ground. The vehicle may suddenly move forward.

### \* NOTICE

If the parking brake warning light is still on even though the EPB has been released, have the system checked by an authorized Kia dealer.

### ⚠ CAUTION

Do not drive your vehicle with the EPB applied. It may cause excessive brake pad and brake rotor wear.

## EPB warning

The EPB will display a warning message with sound under certain conditions.

- If you try to drive off while engaging the accelerator pedal with the EPB applied, but the EPB doesn't release automatically, a warning will sound and a message will appear.
- If the driver's seat belt is not fastened and the vehicle hood, driver's door or liftgate is opened, a warning will sound and a message will appear.

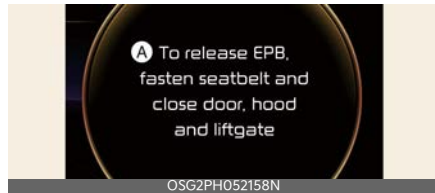

### A: To release EPB, fasten seatbelt and close door, hood and liftgate

- If there is a problem with the vehicle, a warning may sound and a message may appear.

If the above situation occurs, press the brake pedal and release EPB by pressing the EPB switch.

### ⚠ WARNING

#### Parking Brake Use

- Never allow a passenger to touch the parking brake. If the parking brake is released unintentionally, serious injury may occur.
- All vehicles should always have the parking brake fully engaged when parked to avoid inadvertent movement of the vehicles which can injure occupants or pedestrians.
- A click or electric brake motor whine sound may be heard while operating or releasing the EPB. These conditions

are normal and indicate that the EPB is functioning properly.

- When leaving your keys with a parking lot attendant or valet, make sure to inform him/her how to operate the EPB.
- The EPB may malfunction if you drive with the EPB applied.
- When you automatically release EPB by pressing the accelerator pedal, press it slowly.

When the conversion from Auto Hold to EPB is not working properly a warning will sound and a message will appear.

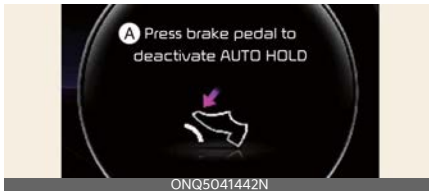

**A: Press brake pedal to deactivate AUTO HOLD**

**\* NOTICE**

Engage the brake pedal when the above message appears for the Auto Hold and EPB may not activate.

If the EPB is applied while Auto Hold is activated because of an Electronic Stability Control (ESC) signal, a warning will sound and a message will appear.

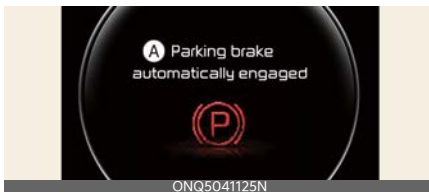

**A: Parking brake automatically engaged**

**EPB malfunction indicator**

This warning light appears if the ENGINE START/STOP button is changed to the ON position and goes off in approximately 3 seconds if the system is operating normally.



If the EPB malfunction indicator remains on, comes on while driving, or does not come on when the ENGINE START/STOP button is changed to the ON position, this indicates that the EPB may have malfunctioned.

If this occurs, have your vehicle checked by an authorized Kia dealer.

The EPB malfunction indicator may appear when the ESC indicator comes on to indicate that the ESC is not working properly, but it does not indicate a malfunction of the EPB.

**\* NOTICE**

The EPB warning light may appear if the EPB switch operates abnormally. Shut the engine off and turn it on again after a few minutes. The warning light will go off and the EPB switch will operate normally. However, if the EPB warning light is still on, have the system checked by an authorized Kia dealer.

If the parking brake warning light does not appear or blinks even though the EPB switch was pulled up, the EPB is not applied.

If the parking brake warning light blinks when the EPB warning light is on, press the EPB switch, then pull it up. Once more press it back to its original position

and pull it back up. If the EPB warning does not go off, have the system checked by an authorized Kia dealer.

### When the EPB is not released

If the EPB does not release normally, take your vehicle to an authorized Kia dealer by loading the vehicle on a flat-bed tow truck and have the system checked.

### Brake Disc Cleaning (BDC)

If there is a surface rust on the brake disc or squeal can be heard, use Brake Disc Cleaning function to reduce noise and rust. While using Brake Disc Cleaning function, the regenerative brake system will be temporarily deactivated and the fuel economy may be reduced.

### Operation

- Press AUTO HOLD button for more than 3 seconds.
  - If the message is shown on the cluster, Brake Disc Cleaning function is activated.
  - Depress the brake pedal around 10 times and the regenerative braking will be temporarily deactivated. The rust and noise will be reduced. Brake Disc Cleaning operation time can change per braking conditions.
  - Brake Disc Cleaning function will be automatically deactivated after operation. To manually turn off, turn the vehicle to OFF position or press AUTO HOLD button for more than 3 seconds

### AUTO HOLD (if equipped)

The Auto Hold is designed to maintain the vehicle in a standstill even though the brake pedal is not pressed after the

driver brings the vehicle to a complete stop by pressing the brake pedal.

### Applying Auto Hold function

1. Press the brake pedal and start the vehicle.
2. Press the Auto Hold button. The white AUTO HOLD indicator will come on indicating the system is in standby.



Before the Auto Hold will engage, the driver's door and engine hood must be closed.

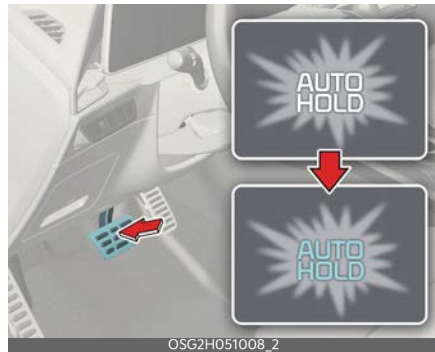

When coming to a complete stop by pressing the brake pedal, the AUTO HOLD indicator changes from white to green indicating the AUTO HOLD is engaged. The vehicle will remain at a standstill even if you release the brake pedal.

If EPB is applied, Auto Hold will be released.

If you press the accelerator pedal with the gear in D (Drive) or Manual mode, the Auto Hold will be released automatically and the vehicle will start to move.



The indicator changes from green to white indicating the Auto Hold is in standby and the EPB is released.

When driving off from Auto Hold by pressing the accelerator pedal, always check the surrounding area near your vehicle.

Slowly press the accelerator pedal for a smooth launch.

### Canceling Auto Hold function



- To cancel the Auto Hold operation, press the Auto Hold switch. The AUTO HOLD indicator will go out.
- To cancel the Auto Hold operation when the vehicle is at a standstill, press the Auto Hold switch while pressing the brake pedal.

#### \* NOTICE

- The following are conditions when the Auto Hold will not engage (Auto Hold light will not turn green and the Auto Hold system remains in stand by):
  - The driver's door is opened
  - The engine hood is opened
  - The gear is in P (Park)
  - The gear is in R (Reverse)
  - The EPB is applied
- For your safety, the Auto Hold automatically switches to EPB under any of the following conditions (Auto Hold light remains white and the EPB automatically applies):
  - The driver's door is opened.
  - The engine hood is opened.

- The vehicle is in a standstill for more than 10 minutes.
- The vehicle is standing on a steep slope.
- The vehicle moved for a few seconds.

In these cases, the brake warning light comes on, the AUTO HOLD indicator changes from green to white, and a warning sounds and a message will appear to inform you that EPB has been automatically engaged. Before driving off again, press foot brake pedal, check the surrounding area near your vehicle and release parking brake manually with the EPB switch.

- If the AUTO HOLD indicator lights up yellow, the Auto Hold is not working properly. Take your vehicle and have the system checked by an authorized Kia dealer.

#### ⚠ WARNING

To reduce the risk of an accident, do not activate Auto Hold while driving down-hill, backing up or parking your vehicle.

If there is a malfunction with the driver's door, liftgate or engine hood open detection system, the Auto Hold may not work properly.

Take your vehicle and have the system checked by an authorized Kia dealer.

#### \* NOTICE

A click or electric brake motor whine sound may be heard while operating or releasing the EPB, but these conditions are normal and indicate that the EPB is functioning properly.

## Warning messages

The Auto Hold function will display a warning message with sound under certain conditions.

When the EPB is applied from Auto Hold, a warning will sound and a message will appear.

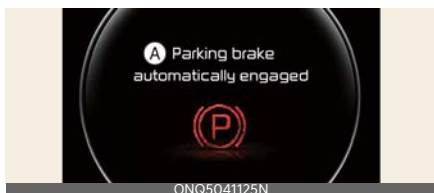

### A: Parking brake automatically engaged

When the conversion from Auto Hold to EPB is not working properly a warning will sound and a message will appear.

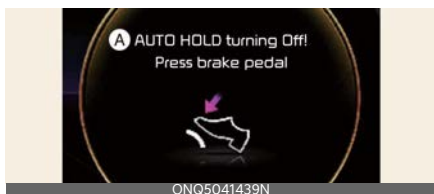

### A: AUTO HOLD turning Off! Press brake pedal

#### \* NOTICE

When this message is displayed, the Auto Hold and EPB may not operate. For your safety, press the brake pedal.

If you do not apply the brake pedal when you release the Auto Hold by pressing the [AUTO HOLD] switch, a warning will sound and a message will appear.

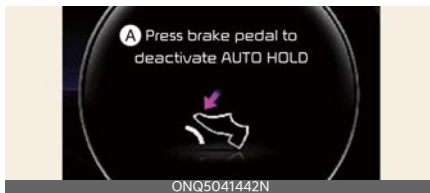

### A: Press brake pedal to deactivate AUTO HOLD

When you press the [AUTO HOLD] switch, if the driver's door and engine hood are not closed, a warning will sound and a message will appear on the LCD display.

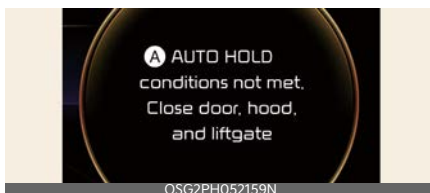

### A: AUTO HOLD conditions not met. Close door, hood and liftgate

At this moment, press the [AUTO HOLD] button after closing the driver's door and engine hood.

## Anti-lock Brake System (ABS)

The Anti-lock Brake System (ABS) prevents the wheels from locking. So the vehicle remains stable and can still be steered.

ABS (or ESC) will not prevent accidents due to improper or dangerous driving maneuvers. Even though vehicle control is improved during emergency braking, always maintain a safe distance between you and objects ahead. Vehicle speeds should always be reduced during extreme road conditions. The vehicle should be driven at reduced speeds in the following circumstances:

- When driving on rough, gravel or snow-covered roads
- When driving on roads where the road surface is pitted or has different surface heights.

Driving in these conditions increases the stopping distance for your vehicle.

The ABS continuously senses the speed of the wheels. If the wheels are going to lock, the ABS repeatedly modulates the hydraulic brake pressure to the wheels. When you apply your brakes under conditions which may lock the wheels, you may hear a "tik-tik" sound from the brakes, or feel a corresponding sensation in the brake pedal. This is normal and it means your ABS is active.

In order to obtain the maximum benefit from your ABS in an emergency situation, do not attempt to modulate your brake pressure and do not try to pump your brakes.

#### \* NOTICE

A click sound may be heard in the vehicle compartment when the vehicle begins to move after the vehicle is started. These conditions are normal and indicate that the Anti-lock Brake System is functioning properly.

Even with the Anti-lock Brake System, your vehicle still requires sufficient stopping distance. Always maintain a safe distance from the vehicle in front of you. Always slow down when cornering. The Anti-lock Brake System cannot prevent accidents resulting from excessive speeds.

On loose or uneven road surfaces, operation of the Anti-lock Brake System may result in a longer stopping distance than

for vehicles equipped with a conventional brake system.

The ABS warning light will stay on for approximately 3 seconds after the ENGINE START/STOP button is ON.



During that time, the ABS will go through self-diagnosis and the light will go off if everything is normal. If the light stays on, you may have a problem with your ABS. Contact and visit an authorized Kia dealer.

When you drive on a road having poor traction, such as an icy road, and have operated your brakes continuously, the ABS will be active continuously and the ABS warning light may appear. Pull your vehicle over to a safe place and stop the vehicle.

Restart the vehicle. If the ABS warning light goes off, then your ABS is normal. Otherwise, you may have a problem with the ABS. Contact and visit an authorized Kia dealer.

#### \* NOTICE

When you jump start your vehicle because of a drained battery, the vehicle may not run as smoothly and the ABS warning light may turn on at the same time. This happens because of low battery voltage. It does not mean your ABS has malfunctioned.

- Do not pump your brakes!
- Have the battery recharged before driving the vehicle.

## Electronic Stability Control (ESC) system

The Electronic Stability Control (ESC) is designed to stabilize the vehicle during cornering maneuvers.



ESC applies the brakes on individual wheels and intervenes with the vehicle management system to stabilize the vehicle.

ESC will not prevent accidents. Excessive speed in turns, abrupt maneuvers and hydroplaning on wet surfaces can still result in serious accidents.

Only a safe and attentive driver can prevent accidents by avoiding maneuvers that cause the vehicle to lose traction. Even with ESC installed, always follow all the normal precautions for driving - including driving at safe speeds for the conditions.

### **⚠ WARNING**

For maximum protection, always wear your seat belt. No system, no matter how advanced, can compensate for all driver error and/or driving conditions. Always drive responsibly.

The ESC system is an electronic system designed to help the driver maintain vehicle control under adverse conditions. It is not a substitute for safe driving practices. Factors including speed, road conditions and driver steering input can all affect whether ESC will be effective in preventing a loss of control. It is still your responsibility to drive and cor-

ner at reasonable speeds and to leave a sufficient margin of safety.

When you apply your brakes under conditions which may lock the wheels, you may hear a "tik-tik" sound from the brakes, or feel a corresponding sensation in the brake pedal. This is normal and it means your ESC is active.

### **\* NOTICE**

A click sound may be heard in the vehicle compartment when the vehicle begins to move after the vehicle is started. These conditions are normal and indicate that the Electronic Stability Control system is functioning properly.

## ESC operation

### ESC ON condition

- When the ENGINE START/STOP button is turned ON, ESC and ESC OFF indicator lights appear for approximately 3 seconds, then ESC is turned on.
- Press the ESC OFF button for at least half a second after turning the vehicle ON to turn ESC off. (ESC OFF indicator will appear). To turn the ESC on, press the ESC OFF button (ESC OFF indicator light will go off).
- When starting the vehicle, you may hear a slight ticking sound. This is the ESC performing an automatic system self-check and does not indicate a problem.

### When operating



When the ESC is in operation, the ESC indicator light blinks.

When the Electronic Stability Control is operating properly, you can feel a slight pulsation in the vehicle. This is only the effect of brake control and indicates nothing unusual.

When moving out of the mud or driving on a slippery road, pressing the accelerator pedal may not cause the vehicle rpm (revolutions per minute) to increase.

### ESC operation off





This vehicle has 2 kinds of ESC off states.

If the vehicle stops when ESC is off, ESC remains off. Upon restarting the vehicle, the ESC will automatically turn on again.



A: Traction Control disabled

### ESC off state 1

To turn off the traction control function and only operate the brake control function of the ESC, press the ESC OFF button (ESC OFF ) for less than 3 seconds and the ESC OFF indicator light (ESC OFF ) will appear.



A: Traction and Stability Control disabled

### ESC off state 2

To turn off the traction control function and the brake control function of the ESC, press the ESC OFF button (ESC

OFF ) for more than 3 seconds. ESC

OFF indicator light (ESC OFF ) will appear and ESC OFF warning chime will sound. At this state, the vehicle stability control function does not operate any more.

### Indicator light

ESC indicator light



ESC OFF indicator light



When ENGINE START/STOP button is turned to ON, the indicator light appears, then goes off if the ESC system is operating normally.

The ESC indicator light blinks whenever ESC is operating or appears when ESC fails to operate.

The ESC OFF indicator light comes on when the ESC is turned off with the button.

**⚠ WARNING****Electronic Stability Control**

Drive carefully even though your vehicle has Electronic Stability Control. It can only assist you in maintaining control under certain circumstances.

**ESC OFF usage****When driving**

- ESC should be turned on for daily driving whenever possible.
- To turn ESC off while driving, press the ESC OFF button while driving on a flat road surface.

**⚠ WARNING****Operating ESC**

Never press the ESC OFF button while ESC is operating (ESC indicator light blinks).

If ESC is turned off while ESC is operating, the vehicle may slip out of control.

**\* NOTICE**

- When operating the vehicle on a dynamometer, ensure that the ESC is turned off (ESC OFF light appeared). If the ESC is left on, it may prevent the vehicle speed from increasing, and result in false diagnosis.
- Turning the ESC off does not affect ABS or brake system operation.

**Hill-start Assist Control (HAC)**

A vehicle has the tendency to roll back on a steep hill when it starts to go after stopping. The Hill-start Assist Control (HAC) prevents the vehicle from rolling

back by applying the brakes automatically for about 2 seconds.

The brakes are released when the accelerator pedal is engaged or after about 2 seconds.

The HAC is activated only for about 2 seconds, so when the vehicle is starting off always engaged the accelerator pedal.

**⚠ WARNING****Maintaining brake pressure on incline**

HAC does not replace the need to apply brakes while stopped on an incline.

While stopped, make sure you maintain brake pressure sufficient to prevent your vehicle from rolling backward and causing an accident. Don't release the brake pedal until you are ready to accelerate forward.

**Vehicle Stability Management (VSM) system**

The Vehicle Stability Management (VSM) provides further enhancements to vehicle stability and steering responses under the following condition:

- when driving on a slippery road or
- when a change in the coefficient of friction between left and right wheels is detected.

**⚠ WARNING****Tire/wheel size**

When replacing tires and wheels, make sure they are the same size as the original tires and wheels installed. Driving with varying tire or wheel sizes may diminish any supplemental safety benefits of the VSM system.

## VSM operation

When the VSM is operating properly, you can feel a slight pulsation in the vehicle and/or abnormal steering responses (Motor Driven Power Steering (MDPS)). This is only the effect of brake and EPS control and indicates nothing unusual.

### The VSM does not operate when:

- Driving on a sloping road such as a gradient or incline
- Driving in reverse
- ESC OFF indicator light () remains on the instrument cluster
- EPS indicator light remains on the instrument cluster

## VSM operation off

If you press the ESC OFF button to turn off the ESC, the VSM will also cancel and the ESC OFF indicator light () appears.

To turn on the VSM, press the button again. The ESC OFF indicator light goes out.

### WARNING

#### Vehicle Stability Management

Drive carefully even though your vehicle has Vehicle Stability Management. It can only assist you in maintaining control of the vehicle under certain circumstances.

#### Malfunction indicator

The VSM can be deactivated even if you don't cancel the VSM operation by pressing the ESC OFF button. It indicates that a malfunction has been detected

somewhere in the Motor Driven Power Steering system or VSM system. If the ESC indicator light () or EPS warning light remains on, take your vehicle and have the system checked by an authorized Kia dealer.

The VSM is not a substitute for safe driving practices but a supplementary function only. It is the responsibility of the driver to always check the speed and the distance to the vehicle ahead. Always hold the steering wheel firmly while driving.

Your vehicle is designed to activate according to the driver's intention, even with installed VSM. Always follow all the normal precautions for driving at safe speeds for the conditions - including driving in clement weather and on a slippery road.

### WARNING

For maximum protection, always wear your seat belt. No system, no matter how advanced, can compensate for all driver error and/or driving conditions. Always drive responsibly.

#### Brake Assistant System (BAS)

The Brake Assistant System provides additional pressure when the brake pedal is momentarily and strongly depressed in a situation sudden braking is required while driving.

The Brake Assistant System reduces the time for ABS (Anti-Lock Brake System) control to enter and consequently reduces the braking distance, by providing additional pressure up to the point of ABS intervention.

## BAS operation

- When the vehicle speed is more than 30 km/h (20 mph) and the ABS control is not entered.
- When the brake pedal is depressed strongly over a certain level.
- When the friction of the road surface is above a certain level.

## BAS operation off

- The vehicle speed is below 10 km/h (6 mph).
- The brake pedal is depressed over a certain conditions.
- The friction of the road surface is below a certain level.

### WARNING

The system may not operate depending on driver's driving habit, the degree to which the brake pedal is depressed and the road surface condition.

## Good braking practices

Good braking practices help keep occupants safe and extend brake life.

- Check to be sure the parking brake is not engaged and the parking brake indicator light is out before driving away.
- Driving through water may get the brakes wet. They can also get wet when the vehicle is washed. Wet brakes can be dangerous! Your vehicle will not stop as quickly if the brakes are wet. Wet brakes may cause the vehicle to pull to one side. To dry the brakes, apply the brakes lightly until the braking action returns to normal, taking care to keep the vehicle under control at all times. If the braking action does not return to

normal, stop as soon as it is safe to do so and visit an authorized Kia dealer.

- Don't coast down hills with the vehicle out of gear. This is extremely hazardous. Keep the vehicle in gear at all times, use the brakes to slow down, then shift to a lower gear so that vehicle braking will help you maintain a safe speed.
- Don't "ride" the brake pedal. Resting your foot on the brake pedal while driving can be dangerous because the brakes might overheat and lose their effectiveness. It also increases the wear of the brake components.
- If a tire goes flat while you are driving, apply the brakes gently and keep the vehicle pointed straight ahead while you slow down. When you are moving slowly enough for it to be safe to do so, pull off the road and stop in a safe place.
- Be cautious when parking on a hill. Firmly engage the parking brake and place the shifter dial in P. If your vehicle is facing downhill, turn the front wheels into the curb to help keep the vehicle from rolling. If your vehicle is facing uphill, turn the front wheels away from the curb to help keep the vehicle from rolling. If there is no curb or if it is required by other conditions to keep the vehicle from rolling, block the wheels.



- Under some conditions your parking brake can freeze in the engaged position. This is most likely to happen when there is an accumulation of snow or ice around or near the rear brakes or if the brakes are wet. If there is a risk that the parking brake may freeze, apply it only temporarily while you put the shifter dial in P (Parking) and block the rear wheels so the vehicle cannot roll. Then release the parking brake.
  - Do not hold the vehicle on an incline with the accelerator pedal. This can cause the transmission to overheat. Always use the brake pedal or parking brake.
  - Do not pump the brake pedal as the vehicle is equipped with ABS.
  - The vehicle is equipped with electronic hydraulic brake. Due to malfunction or power instability, the brake booster may not operate normally and cause the brake pedal to feel stiff, resulting in longer braking distances. In this case, stop the vehicle by depressing the brake pedal stronger than usual. Have the system inspected by authorized Kia dealer.
  - The sound of electronic hydraulic brake operating or its motor may be heard temporarily when:
    - Repeatedly depressing the brake pedal
    - Opening driver's door
  - When driving on the road to which deicing chemicals are applied, the vehicle may witness noises from the brake or abnormal abrasion of tires because of such deicing chemicals. You should operate brake additionally so that you would be able to remove the deicing chemicals on the brake disk and pad under a safe traffic condition.
- 

**\* NOTICE**

- When stepping on the brake pedal under a certain driving or weather condition, you may witness your car make a sound of squealing or some other noises. This is not a brake malfunction but a normal phenomenon.

## Vehicle Auto Shut-off system (if equipped)

If your vehicle is parked and the engine is left on for a long period of time, the engine will turn off automatically to help reduce fuel consumption and prevent accidents caused by carbon dioxide poisoning.

### Operating Conditions

Vehicle Auto-Shut Off timer operates when all the following conditions are satisfied:

- Vehicle speed is below 3km/h (2 mph), and the gear is shifted to P (Park)
- The brake pedal and accelerator pedal are not depressed
- The driver's seat belt is unfastened
- The passenger seat is empty
- The infotainment system is being updated

### Deactivating Conditions

Vehicle Auto-Shut Off timer turns off when one of the situation occur:

- Vehicle speed is above 3 km/h (2 mph)
- The gear is shifted to R (Reverse), D (Drive) or N (Neutral)
- The brake pedal or accelerator pedal is depressed
- The driver's seat belt is fastened
- A passenger is in the passenger's seat

## System Operation



**A: Vehicle will be turned off automatically in:**

**B: Reset**

When all the conditions are satisfied, the Vehicle Auto-Shut Off operates and turns the engine off automatically after 60 minutes.

A timer appears on the instrument cluster 30 minutes before vehicle shut off.

### Resetting cluster timer

To reset the cluster timer, do one of following:

- Release the accelerator pedal or brake pedal after Vehicle Auto-Shut Off is complete.
- Press the OK button on the steering wheel while the timer appears on the instrument cluster.

### **⚠ CAUTION**

Do not leave a passenger or a pet in the vehicle in hot weather since the air conditioning system turns off when the engine is off.

## Drive mode integrated control system

### Drive mode

The drive mode may be selected according to the driver's preference or road condition.



The Drive mode is activated by turning the knob.

#### \* NOTICE

If there is a problem with the instrument cluster, the drive mode will be in ECO mode and may not change to SPORT mode.

The mode changes when you toggle the DRIVE MODE button.



- ECO mode:  
ECO mode helps improve fuel efficiency for eco-friendly driving.
- SPORT mode:  
SPORT mode provides sporty but fun riding.

The drive mode will change to ECO mode when the vehicle is restarted.

When changing the drive mode setting, the responsiveness of Smart Cruise Control changes. (If equipped)

Mode	Characteristics	SCC Responsiveness
ECO	Improves fuel efficiency for eco-friendly driving	Slow
SPORT	Provides sporty and fun riding	Fast

### ECO mode

**ECO** When the Drive Mode is set to ECO mode, the engine and transmission control logic are changed to maximize fuel efficiency.

- When the ECO mode is selected by using the DRIVE MODE button, the ECO indicator will illuminate.
- Whenever the vehicle is restarted, the drive mode remains in ECO mode.

#### \* NOTICE

Fuel efficiency depends on the driver's driving habit and road condition.

### When ECO mode is activated:

- The acceleration response may be slightly reduced as the accelerator pedal is depressed moderately.
- The air conditioner performance may be limited.
- The shift pattern of the automatic transmission may change.
- The engine noise may get louder.

The above situations are normal conditions when ECO mode is activated to improve fuel efficiency.

### Limitation of ECO mode operation:

If the following conditions occur while ECO mode is operating, the system operation is limited even though there is no change in ECO indicator.

- When the coolant temperature is low:

The system will be limited until engine performance becomes normal.

- When driving up a hill:  
The system will be limited to gain power when driving uphill because engine torque is restricted.
- When the accelerator pedal is deeply depressed for a few seconds:  
The system will be limited, judging that the driver wants to speed up.

### SPORT mode

**SPORT** SPORT mode manages the driving dynamics by automatically adjusting the steering effort, the engine and transmission control logic for enhanced driver performance.

- When SPORT mode is selected by using the DRIVE MODE button, the SPORT indicator will illuminate.
- Whenever the vehicle is restarted, the Drive Mode will revert back to ECO mode. If SPORT mode is desired, re-select SPORT mode from the DRIVE MODE button.
- When SPORT mode is activated:
  - The engine rpm will tend to remain raised over a certain length of time even after releasing the accelerator
  - Upshifts are delayed when accelerating

### \* NOTICE

In SPORT mode, the fuel efficiency may decrease.

## Green Zone Drive Mode

In order to protect the atmospheric environment in urban areas, EV mode is expanded when entering the road inside the green zone based on the navigation information.

Also, EV mode is expanded based on the driving history when departing from home.

### Operation

With the vehicle on, touch **Settings** → **Eco Vehicle** → **Green Zone EV Drive** on the instrument cluster, or touch **Settings** → **Vehicle** → **Eco Vehicle** → **Green Zone EV Drive** on the infotainment system.

### \* INFORMATION

The infotainment system may change after software updates. For more information, refer to the user's manual provided in the infotainment system and the quick reference guide.

### Green Zone Drive Mode LCD display

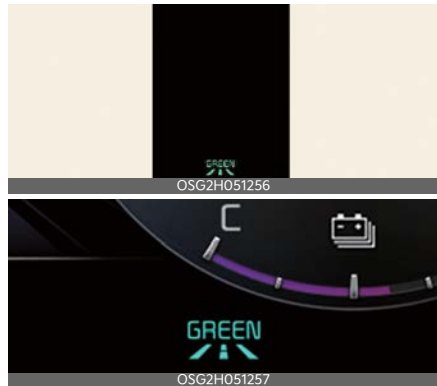

Enable Green Zone Drive Mode when entering green zone in ECO mode.

## Green zone registration point

Based on navigation information and driving history.

1. School
2. Large hospitals
3. Registered favorites (Home/Office/  
Favorite 1, 2, 3)
4. Large shopping mall
5. Park (Public, National, etc.)

### \* INFORMATION

A change may occur through regular navigation updates.

### ⚠ CAUTION

Even in the Green Zone, the EV mode driving ability may be reduced or the engine may start in the following situations:

- If the battery charge is low.
- If the engine power is required (acceleration/climbing/heating/cooling) or engine start is required for driving system operation.
- If Green Zone recognition is not possible due to navigation problems.

## Active air flap



Active air flap system controls the air flap below the front bumper to cool the vehicle parts and improve energy efficiency.

## Active air flap malfunction



### A: Check Active Air Flap System

The active air flap system may not operate normally if the air flap is temporarily opened due to foreign factors or if the controller is contaminated by snow or rain, etc.

When the message is popped up on the display, stop the vehicle in a safe place and check the status of the air flap.

Start the vehicle after performing the necessary work like foreign matter removal and waiting 10 minutes. If the pop-up remains up, have the vehicle inspected by an authorized Kia dealer.

**⚠ CAUTION**

- Regardless of the pop-up, if the air flaps aren't in the same position, stop the vehicle and wait for 10 minutes and start the vehicle and inspect the air flap.
- The active air flap system is actuated by motors. Do not disturb actuation or apply force excessively. It may cause failure.

**\* NOTICE**

Active air flap system could be activate regardless of the vehicle condition. (Parking, driving, charging, etc.)

**Forward Collision-Avoidance Assist (FCA) (Front Camera Only) (if equipped)**



Forward Collision-Avoidance Assist is designed to help detect and monitor the vehicle ahead or help detect pedestrian or cyclist in the roadway and warn the driver that a collision is imminent with a warning message and an audible warning, apply emergency braking.

**Detecting sensor**

Front view camera



Refer to the picture above for the detailed location of the detecting sensors.

**⚠ CAUTION**

- Never disassemble the detecting sensor or sensor assembly, or cause any damage to it.
- If the detecting sensors have been replaced or repaired, have the vehicle inspected by an authorized Kia dealer.
- Never install any accessories or stickers on the front windshield, or tint the front windshield.

- Pay extreme caution to keep the front view camera dry.
- Never place any reflective objects (for example, white paper, mirror) over the dashboard.
- Do not place any objects near the front windshield or install any accessories on the front windshield. It can affect the performance of the defogging and defrosting function of the climate control system, which may prevent the Driver Assistance systems from operating.

## Forward Collision-Avoidance Assist settings

### Forward safety



#### A: Driver Assistance

- 1 Driving Safety
- 2 Forward Safety

With the vehicle on, touch **Settings** → **Driver Assistance** → **Driving Safety** on the instrument cluster or **Settings** → **Vehicle** → **Driver Assistance** → **Driving Safety** on the infotainment system. The initial warning activation timing of Forward Collision-Avoidance Assist can be changed.

- **Forward Safety:** Depending on the collision risk levels, an audible warning will sound and the braking will be assisted. If the following menu is deactivated, Forward Collision-Avoidance Assist will turn off and the warning light (🚗) will appear on the cluster.

The driver can monitor Forward Collision-Avoidance Assist On/Off status from the Settings menu. If the warning light (🚗) remains ON when Forward Collision-Avoidance Assist is on, have the vehicle inspected by an authorized Kia dealer.

### ⚠ WARNING

When the vehicle is restarted, Forward Collision-Avoidance Assist will always turn on. However, if **Forward safety** is deselected, the driver should always be aware of the surroundings and drive safely.

### \* INFORMATION

The infotainment system may change after software updates. For more information, refer to the user's manual provided in the infotainment system and the quick reference guide.

### Forward Safety Warning Timing

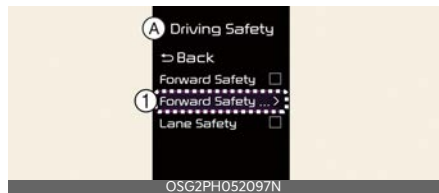



**A: Driving Safety**

- 1 Forward Safety Warning Timing**
- 2 Standard**
- 3 Late**

With the vehicle on, touch **Settings** → **Driver Assistance** → **Driving Safety** → **Forward Safety Warning Timing** on the instrument cluster or **Settings** → **Vehicle** → **Driver Assistance** → **Driving Safety** → **Forward Safety Warning Timing** on the infotainment system to change the initial warning activation timing of Forward Collision-Avoidance Assist.

- Use **Standard** in normal driving conditions. If the Warning Timing seems sensitive, change it to **Late**.
- If **Late** is selected, Forward Collision-Avoidance Assist, warns the driver more slowly.

**\* INFORMATION**

The infotainment system may change after software updates. For more information, refer to the user's manual provided in the infotainment system and the quick reference guide.

**Warning Sound and Haptic**



**A: Driver Assistance**

- 1 Warning Sound and Haptic**
- 2 Warning Volume**
- 3 Driving Safety Priority**

With the vehicle on, touch **Settings** → **Vehicle** → **Driver Assistance** → **Warning Style** on the infotainment system to change the Warning Style.

- **Warning Volume:** You can adjust the Warning Volume from level 1 to 3. If equipped with steering wheel vibration, the volume level can be set from 0 to 3.
- **Driving Safety Priority:** For safe driving, the audio volume will temporarily decrease to warn the driver with the audible warning.

**\* NOTICE**

- Ensure that Warning Style you have set may apply to the Warning volume of other Driver Assistance systems.
- Warning Style will maintain its last setting even if the vehicle is restarted.
- If not equipped with the navigation system, select **User Settings** → **Driver Assistance** to adjust the Warning Volume.
- The setting menu may not be available for your vehicle depending on the vehicle features and specifications.
- Descriptions of each Driver Assistance system may be slightly different from



the owner's manual after updating the software of your infotainment system. In this case, scan the QR code in the infotainment system manual to access the web manual for checking the changes.

## Forward Collision-Avoidance Assist operation

Forward Collision-Avoidance Assist is warned and controlled by the following action.

- Collision warning
- Emergency braking
- Stopping vehicle and ending brake control

### Collision warning



#### A: Collision Warning

Collision warning will alert the driver with a warning message and an audible warning.

Collision Warning will be activated in the following conditions.

- Your driving speed: 10~180 km/h (6~112 mph)
- Pedestrian or cyclist: 10~80 km/h (6~50 mph)

## Emergency braking



#### A: Emergency Braking

The warning message, an audible warning will sound to warn the driver that emergency braking will be assisted. The brake assist will be activated and it helps avoiding collision of a vehicle, pedestrian and cyclist.

Emergency braking will be activated in the following conditions.

- Your driving speed: 10~60 km/h (6~37 mph)
- Pedestrian or cyclist: 10~60 km/h (6~37 mph)

### ⚠ CAUTION

The function operation range may decrease due to the front traffic condition or the surroundings of the vehicle.

## Stopping vehicle and ending brake control



#### A: Drive carefully

When the vehicle is stopped due to emergency braking, the warning message will appear on the cluster.

For your safety, the driver should depress the brake pedal immediately and check the surroundings.

- Brake control will end after the vehicle is stopped by emergency braking for approximately 2 seconds.

### **WARNING**

- For your safety, change the Settings after parking the vehicle at a safe location.
- It is the driver's responsibility to be in control of the vehicle. It is dangerous to rely heavily on the Forward Collision Assist. Drive safely and always keep a safe following distance.
- Forward Collision-Avoidance Assist may not operate in all situations. In certain situations, it could not avoid collisions even if the function operates.
- Forward Collision-Avoidance Assist could stop, not operate, or unnecessarily operate the function, depending on road conditions, surroundings and driving conditions. Always pay attention to your surroundings and be prepared for potential collisions/dangerous situations.
- Never deliberately operate Forward Collision-Avoidance Assist on people, objects, etc. It may cause serious injury or death.
- Forward Collision-Avoidance Assist may not operate if the driver depresses the brake pedal to avoid collision.
- During Forward Collision-Avoidance Assist operation, the vehicle may stop suddenly injuring passengers and shifting loose objects. Always have the seat belt on and keep loose objects secured.

- If any other function's warning message is displayed or audible warning is generated, Forward Collision-Avoidance Assist warning message may not be displayed and audible warning may not be generated.
- You may not hear the warning sound of Forward Collision-Avoidance Assist if the surrounding is noisy.
- Forward Collision-Avoidance Assist may turn off or may not operate properly or may operate unnecessarily depending on the road conditions and the surroundings.
- Even if there is a problem with Forward Collision-Avoidance Assist, the vehicle's basic braking performance will operate properly.
- During emergency braking, braking control by Forward Collision-Avoidance Assist will automatically cancel when the driver excessively depresses the accelerator pedal or sharply steers the vehicle.

### **CAUTION**

Depending on the condition of the vehicle, pedestrian and cyclist in front and the surroundings, the speed range to operate Forward Collision-Avoidance Assist may reduce. Forward Collision-Avoidance Assist may only warn the driver, or it may not operate.

### **NOTICE**

- When a collision is imminent, the Forward Collision-Avoidance Assist may assist the driver with brakes if the driver fails to brake enough.
- The images and colors in the instrument cluster may differ depending on

the cluster type or theme selected from the settings menu.

## Forward Collision-Avoidance Assist malfunction and limitations

### Forward Collision-Avoidance Assist malfunction



#### A: Check Forward Safety system

If the vehicle detects a malfunction in the Forward Collision-Avoidance Assist, a warning message is displayed with master warning light (⚠️), Forward Safety warning light (🌟) on the cluster. In this case, have your vehicle inspected by an authorized Kia dealer.

### Forward Collision-Avoidance Assist disabled

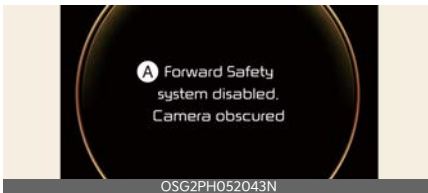

#### A: Forward Safety system disabled. Camera obscured

When the front windshield where the front view camera is located, front radar cover or sensor is covered with foreign material, such as snow or rain, it can reduce the detecting performance and temporarily limit or disable Forward Collision-Avoidance Assist.

If this occurs the warning message, and the (🌟) and (⚠️) warning lights will appear on the cluster.

Forward Collision-Avoidance Assist will operate properly when snow, rain or foreign material is removed.

If Forward Collision-Avoidance Assist does not operate properly after obstruction (snow, rain, or foreign material) is removed, have the vehicle inspected by an authorized Kia dealer.

### ⚠️ WARNING

- Even though the warning message or warning light does not appear on the cluster, Forward Collision-Avoidance Assist may not properly operate.
- Forward Collision-Avoidance Assist may not properly operate in an area (e.g. open terrain), where there is nothing to detect, or detecting sensor is covered in foreign material after turning ON the vehicle.

### Limitations of Forward Collision-Avoidance Assist

Forward Collision-Avoidance Assist may not operate properly, or it may operate unexpectedly under the following circumstances:

- The detecting sensor or the surroundings are contaminated or damaged
- The temperature around the front view camera is high or low due to surrounding environment
- The camera lens is contaminated due to tinted, filmed or coated windshield, damaged glass, or sticky foreign material (sticker, bug, etc.) on the glass
- Moisture is not removed or frozen on the windshield

- Washer fluid is continuously sprayed, or the wiper is on
- Driving in heavy rain or snow, or thick fog
- The field of view of the front view camera is obstructed by sun glare
- Street light or light from an oncoming traffic is reflected on the wet road surface, such as a puddle on the road
- An object is placed on the dashboard
- Your vehicle is being towed
- The surrounding is very bright or the surrounding is very dark, such as in a tunnel, etc.
- The brightness changes suddenly, for example when entering or exiting a tunnel
- The brightness outside is low, and the headlamps are not on or are not bright
- Only part of the vehicle, pedestrian or cyclist is detected
- The vehicle in front is a bus, heavy truck, truck with an unusually shaped cargo, trailer, etc.
- The vehicle in front has no tail lights, tail lights are located unusually, etc.
- The brightness outside is low, and the tail lamps are not on or are not bright
- The rear of the front vehicle is small or the vehicle does not look normal, such as when the vehicle is tilted, overturned, or the side of the vehicle is visible, etc.
- The front vehicle's ground clearance is low or high
- A vehicle, pedestrian or cyclist suddenly cuts in front
- The vehicle in front is detected late
- The vehicle in front is suddenly blocked by an obstacle
- The vehicle in front suddenly changes lane or suddenly reduces speed
- The vehicle in front is bent out of shape
- The front vehicle speed is fast or slow
- The vehicle in front steers in the opposite direction of your vehicle to avoid a collision
- With a vehicle in front, your vehicle changes lane at low speed
- The vehicle in front is covered with snow
- You are departing or returning to the lane
- Unstable driving
- You are on a roundabout and the vehicle or motorcycle in front is not detected
- You are continuously driving in a circle
- The vehicle in front has an unusual shape
- The vehicle in front is driving uphill or downhill
- The pedestrian or cyclist is not fully detected, for example, if the pedestrian is leaning over or is not fully walking upright
- The pedestrian or cyclist is wearing clothing or equipment that makes it difficult to detect



The illustration above shows the image the front view camera and front radar are capable of detecting as a vehicle, pedestrian and cyclist.

- The pedestrian or cyclist in front is moving very quickly
- The pedestrian or cyclist in front is short or is posing a low posture
- The pedestrian or cyclist in front has impaired mobility or moving intersected with the driving direction
- There is a group of pedestrians, cyclists or a large crowd in front
- The pedestrian or cyclist is wearing clothing that easily blends into the background, making it difficult to detect
- The pedestrian or cyclist is difficult to distinguish from the similarly shaped structure in the surroundings
- You are driving by a pedestrian, cyclist, traffic signs, structures, etc., near the intersection
- When driving in the following places
  - Driving through steam, smoke or shadow
  - Driving through a tunnel or iron bridge
  - Driving in large areas where there are few vehicles or structures (i.e. desert, meadow, suburb, etc.)
  - Driving in a parking lot
  - Driving through toll gate, construction areas, partially paved roads, bumpy roads, speed bumps, etc.
  - Driving near areas containing metal substances, such as a construction zone, railroad, etc.
  - Driving on an incline road, curved road, etc.
  - Driving through a roadside with trees or streetlights
  - Driving through a narrow road where trees or grass are overgrown
- There is interference by electro-magnetic waves, such as driving in an area with strong radio waves or electrical noise
- The adverse road conditions cause excessive vehicle vibrations while driving
- Your vehicle height is low or high due to heavy loads, abnormal tire pressure, etc.

### ⚠ WARNING

- Driving on a curved road



Forward Collision-Avoidance Assist may not detect other vehicles, pedestrians or cyclists in front of you when driving on curved roads adversely affecting the performance of the sensors. This may result in no warning, braking assist when necessary.

When driving on a curve, you must maintain a safe braking distance, and if necessary, steer the vehicle and depress the brake pedal to reduce your driving speed in order to maintain a safe distance.



Forward Collision-Avoidance Assist may detect a vehicle, pedestrian or cyclist in the next lane or outside the lane when driving on a curved road.

If this occurs, Forward Collision-Avoidance Assist may unnecessarily warn the driver and control the brake. Always check the traffic conditions around the vehicle.

- Driving on an inclined road



Forward Collision-Avoidance Assist may not detect other vehicles, pedestrians or cyclists in front of you while driving uphill or downhill, adversely affecting the performance of the sensors.

This may result in unnecessary warning, braking assist or no warning, braking assist when necessary.

Also, vehicle speed may rapidly decrease when a vehicle, pedestrian or cyclist ahead is suddenly detected. Always have your eyes on the road while driving uphill or downhill and if necessary, steer your vehicle and depress the brake pedal to reduce your driving speed in order to maintain a safe distance.

- Changing lanes



[A]: Your vehicle,

[B]: Lane changing vehicle

When a vehicle (B) moves into your lane from an adjacent lane, it cannot be detected by the sensor until it is in the sensor's detection range.

Forward Collision-Avoidance Assist may not immediately detect the vehicle when the vehicle changes lanes abruptly. In this case, you must maintain a safe braking distance, and if necessary, steer your vehicle and depress the brake pedal to reduce your driving speed in order to maintain a safe distance.



- [A]: Your vehicle,
- [B]: Lane changing vehicle,
- [C]: Same lane vehicle

When a vehicle (B) in front of you merges out of the lane, Forward Collision-Avoidance Assist may not immediately detect the vehicle (C) that is now in front of you. In this case, you must maintain a safe braking distance, and if necessary, steer your vehicle and depress the brake pedal to reduce your driving speed in order to maintain a safe distance.

- Detecting vehicle



If the vehicle in front of you has cargo that extends rearward from the cab,

or when the vehicle in front of you has higher ground clearance, additional special attention is required. Forward Collision-Avoidance Assist may not be able to detect the cargo extending from the vehicle. In these instances, you must maintain a safe braking distance from the rearmost object, and if necessary, steer your vehicle and depress the brake pedal to reduce your driving speed in order to maintain distance.

**⚠ WARNING**

- When you are towing a trailer or another vehicle, turn off Forward Collision-Avoidance Assist for safety reasons.
- Forward Collision-Avoidance Assist may operate if objects that are similar in shape or characteristics to vehicles, motorcycles, pedestrians and cyclists are detected.
- Forward Collision-Avoidance Assist does not operate on bicycles, or smaller wheeled objects, such as luggage bags, shopping carts, or strollers.
- Forward Collision-Avoidance Assist may not operate properly if interfered by strong electromagnetic waves.
- Forward Collision-Avoidance Assist may not operate for 15 seconds after the vehicle is started, or the front view camera is initialized.

**This device complies with Industry Canada licence-exempt RSS standard(s).**

Operation is subject to the following conditions:

1. This device may not cause interference, and
2. This device must accept any interference, including interference that may cause undesired operation of the device.
3. Changes or modifications not expressly approved by the party responsible for compliance could void the user's authority to operate the device.

## Forward Collision-Avoidance Assist (FCA) (Sensor Fusion) (if equipped)

### Basic function



Forward Collision-Avoidance Assist is designed to help detect and monitor the vehicle ahead or help detect a powered two-wheeler, pedestrian or cyclist in the roadway and warn the driver that a collision is imminent with a warning message and warning and apply emergency braking.

### Junction Turning function

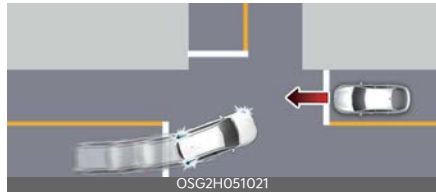

Junction Turning function can help avoid a collision with an oncoming vehicle in an adjacent lane when turning left at a crossroad with the turn signal on by applying emergency braking.



## Detecting sensor

Front view camera



Front radar



Refer to the picture above for the detailed location of the detecting sensors.

### **CAUTION**

Take the following precautions to maintain optimal performance of the detecting sensor:

- Never disassemble the detecting sensor or sensor assembly, or cause any damage to it.
- If the detecting sensors have been replaced or repaired, have the vehicle inspected by an authorized Kia dealer.
- Never install any accessories or stickers on the front windshield, or tint the front windshield.
- Pay extreme caution to keep the front view camera dry.
- Never place any reflective objects (for example, white paper, mirror) over the dashboard.
- Do not place any objects near the front windshield or install any accessories on the front windshield. It can affect the performance of the defog-

ging and defrosting function of the climate control system, which may prevent the Driver Assistance systems from operating.

- Do not apply license plate frame or objects, such as a bumper sticker, film or a bumper guard, near the front radar cover.
- Do not arbitrarily change the location of license plates or install the license plate molds. It may affect the control or detection performance of the front radar sensor.
- Always keep the front radar and cover clean and free of dirt and debris. Use only a soft cloth to wash the vehicle. Do not spray pressurized water directly on the sensor or sensor cover.
- If the radar or around the radar has been damaged or impacted in any way, Forward Collision-Avoidance Assist may not properly operate even though a warning message does not appear on the cluster. Have the vehicle inspected by an authorized Kia dealer.
- The genuine Kia front radar sensor covers are parts with quality and performance ensured. If arbitrarily applying paint on or changing the cover, Forward Collision-Avoidance Assist may not function properly. Use only Kia Genuine Parts or those of an equivalent standard with proven quality and performance to repair or replace the radar sensor covers.

## Forward Collision-Avoidance Assist settings

### Forward safety



#### A: Driver Assistance

- 1 Driving Safety
- 2 Forward Safety

With the vehicle on, touch **Settings** → **Driver Assistance** → **Driving Safety** on the instrument cluster or **Settings** → **Vehicle** → **Driver Assistance** → **Driving Safety** on the infotainment system. The initial warning activation timing of Forward Collision-Avoidance Assist can be changed.

- **Forward Safety:** Depending on the collision risk levels, an audible warning will sound and the braking will be assisted. If this menu is deselected, Forward Collision-Avoidance Assist will turn off and the warning light (🚨) will appear on the cluster.

The driver can monitor Forward Collision-Avoidance Assist On/Off status from the Settings menu. If the warning light (🚨) remains ON when Forward Collision-Avoidance Assist is on, have the vehicle inspected by an authorized Kia dealer.

### ⚠ WARNING

When the vehicle is restarted, Forward Collision-Avoidance Assist will always turn on. However, if **Forward Safety** is deselected, the driver should always be aware of the surroundings and drive safely.

### \* INFORMATION

The infotainment system may change after software updates. For more information, refer to the user's manual provided in the infotainment system and the quick reference guide.

### Forward Safety Warning Timing



#### A: Driving safety

- 1 Forward Safety Warning Timing
- 2 Standard
- 3 Late

With the vehicle on, touch **Settings** → **Driver assistance** → **Driving Safety** → **Forward Safety Warning Timing** on the instrument cluster or **Settings** → **Vehicle** → **Driver assistance** → **Driving safety** → **Forward Safety Warning Timing** on the infotainment system to

change the initial warning activation timing of Forward Collision-Avoidance Assist.

- Use **Standard** in normal driving conditions. If the Warning Timing seems sensitive, change it to **Late**.
- If **Late** is selected, Forward Collision-Avoidance Assist, warns the driver more slowly.

### \* INFORMATION

The infotainment system may change after software updates. For more information, refer to the user's manual provided in the infotainment system and the quick reference guide.

## Warning Sound and Haptic



A: Driver Assistance

1 Warning Sound and Haptic

2 Warning Volume

3 Driving Safety Priority

With the vehicle on, touch **Settings** → **Vehicle** → **Driver Assistance** → **Warning Style** on the infotainment system to change the Warning Style.

- **Warning Volume:** You can adjust the Warning Volume from level 1 to 3. If equipped with steering wheel vibration, the volume level can be set from 0 to 3.
- **Driving Safety Priority:** For safe driving, the audio volume will temporarily

decrease to warn the driver with the audible warning.

### \* NOTICE

- Ensure that Warning Style you have set may apply to the Warning volume of other Driver Assistance systems.
- Warning Style will maintain its last setting even if the vehicle is restarted.
- If not equipped with the navigation system, select **User Settings** → **Driver Assistance** to adjust the Warning Volume.
- The setting menu may not be available for your vehicle depending on the vehicle features and specifications.
- Descriptions of each Driver Assistance system may be slightly different from the owner's manual after updating the software of your infotainment system. In this case, scan the QR code in the infotainment system manual to access the web manual for checking the changes.

## Forward Collision-Avoidance Assist operation

### Basic function

The basic function for Forward Collision-Avoidance Assist is warned and controlled by the following action.

- Collision warning
- Emergency braking
- Stopping vehicle and ending brake control

## Collision warning



### A: Collision Warning

Collision warning will alert the driver with a warning message and an audible warning.

Collision Warning will be activated in the following conditions.

- Your vehicle and powered two-wheeler: 10~200 km/h (6~124 mph)
- Pedestrian or cyclist: 10~85 km/h (6~53 mph)

## Emergency braking



### A: Emergency Braking

The warning message, an audible warning will sound to warn the driver that emergency braking will be assisted. The brake assist will be activated and it helps avoiding collision of a vehicle, pedestrian and cyclist.

Emergency braking will be activated in the following conditions.

- Your vehicle and powered two-wheeler:

	Driving target	Stopped target
Weak braking power	10~200 km/h (6~124 mph)	
Strong braking power	10~130 km/h (6~80 mph)	10~75 km/h (6~47 mph)

- Pedestrian or cyclist: 10~65 km/h (6~40 mph)

## ⚠ CAUTION

The function operation range may decrease due to the front traffic condition or the surroundings of the vehicle.

## Stopping vehicle and ending brake control



### A: Drive carefully

When the vehicle is stopped due to emergency braking, the warning message will appear on the cluster.

For your safety, the driver should depress the brake pedal immediately and check the surroundings.

- Brake control will end after the vehicle is stopped by emergency braking for approximately 2 seconds.

## Junction Turning function

The basic function for Junction turning function is warned and controlled by the following action.

- Collision warning
- Emergency braking
- Stopping vehicle and ending brake control

## Collision warning



### A: Collision Warning

Collision warning will alert the driver with a warning message and an audible warning.

Collision warning will be activated in the following conditions.

- Your driving speed: 10~30 km/h (6~19 mph)
- Oncoming vehicle speed: 30~70 km/h (19~44 mph)

## Emergency braking



### A: Emergency Braking

The warning message, an audible warning will sound to warn the driver that emergency braking will be assisted. The brake assist will be activated and it helps avoiding collision of a vehicle.

Emergency braking will be activated in the following conditions.

- Your driving speed: 10~30 km/h (6~19 mph)
- Oncoming vehicle speed: 30~70 km/h (19~44 mph)

## Stopping vehicle and ending brake control



### A: Drive carefully

When the vehicle is stopped due to emergency braking, the warning message will appear on the cluster. For your safety, the driver should depress the brake pedal immediately and check the surroundings.

- Brake control will end after the vehicle is stopped by emergency braking for approximately 2 seconds.

### \* NOTICE

For more details on warning messages, refer to "Collision warning" on page 6-72.

### ⚠ WARNING

- For your safety, change the Settings after parking the vehicle at a safe location.
- The driver should hold the responsibility to control the vehicle. Do not solely depend on Forward Collision-Avoidance Assist. Rather, maintain a safe braking distance, and if necessary, depress the brake pedal to reduce driving speed or to stop the vehicle.
- Forward Collision-Avoidance Assist may not operate in all situations. In certain situations, it could not avoid a collision even if the function operates.
- Forward Collision-Avoidance Assist could stop, not operate, or unnecessarily operate the function, depending

on road conditions, surroundings and driving conditions. Always pay attention to your surroundings and be prepared for potential collisions/ dangerous situations.

- Never deliberately operate Forward Collision-Avoidance Assist on people, objects, etc. It may cause serious injury or death.
- Forward Collision-Avoidance Assist may not operate if the driver depresses the brake pedal to avoid collision.
- During Forward Collision-Avoidance Assist operation, the vehicle may stop suddenly injuring passengers and shifting loose objects. Always have the seat belt on and keep loose objects secured.
- If any other function's warning message is displayed or audible warning is generated, Forward Collision-Avoidance Assist warning message may not be displayed and audible warning may not be generated.
- You may not hear the warning sound of Forward Collision-Avoidance Assist if the surrounding is noisy.
- Even if there is a problem with Forward Collision-Avoidance Assist, the vehicle's basic braking performance will operate properly.
- During emergency braking, braking control by Forward Collision-Avoidance Assist will automatically cancel when the driver excessively depresses the accelerator pedal or sharply steers the vehicle.

roundings, the speed range to operate Forward Collision-Avoidance Assist may reduce. Forward Collision-Avoidance Assist may only warn the driver, or it may not operate.

- Forward Collision-Avoidance Assist will operate under certain conditions by judging the risk level based on the condition of the oncoming vehicle, driving direction, speed and surroundings.

**\* NOTICE**

- In a situation where collision is imminent, braking may be assisted by Forward Collision-Avoidance Assist when braking is insufficient by the driver.
- The images and colors in the instrument cluster may differ depending on the cluster type or theme selected from the settings menu.

**Forward Collision-Avoidance Assist malfunction and limitations**

**Forward Collision-Avoidance Assist malfunction**

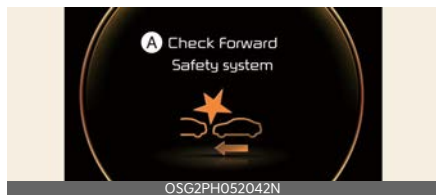

**A: Check Forward Safety system**

If the vehicle detects a malfunction in the Forward Collision-Avoidance Assist, a warning message is displayed with master warning light (⚠), Forward Safety warning light (🚗) on the cluster. In this case, have your vehicle inspected by an authorized Kia dealer.

**⚠ CAUTION**

- Depending on the condition of the vehicle, powered two-wheeler, pedestrian and cyclist in front and the sur-

## Forward Collision-Avoidance Assist disabled

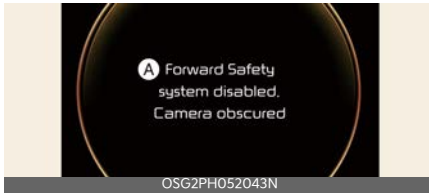

### A: Forward Safety system disabled. Camera obscured

When the front windshield where the front view camera is located, front radar cover or sensor is covered with foreign material, such as snow or rain, it can reduce the detecting performance and temporarily limit or disable Forward Collision-Avoidance Assist.

If this occurs the warning message, and the (🚗) and (⚠️) warning lights will appear on the cluster.

Forward Collision-Avoidance Assist will operate properly when snow, rain or foreign material is removed.

If Forward Collision-Avoidance Assist does not operate properly after obstruction (snow, rain, or foreign material) is removed, have the vehicle inspected by an authorized Kia dealer.

### **⚠️ WARNING**

- Even though the warning message or warning light does not appear on the cluster, Forward Collision-Avoidance Assist may not properly operate.
- Forward Collision-Avoidance Assist may not properly operate in an area (for example, open terrain) or when the sensor is covered with foreign material, such as snow or rain, any objects are not detected after turning ON the vehicle.

## Limitations of Forward Collision-Avoidance Assist

Forward Collision-Avoidance Assist may not operate properly, or it may operate unexpectedly under the following circumstances:

- The detecting sensor or the surroundings are contaminated or damaged
- The temperature around the front view camera is high or low due to surrounding environment
- The camera lens is contaminated due to tinted, filmed or coated windshield, damaged glass, or sticky foreign material (sticker, bug, etc.) on the glass
- Moisture is not removed or frozen on the windshield
- Washer fluid is continuously sprayed, or the wiper is on
- Driving in heavy rain or snow, or thick fog
- The field of view of the front view camera is obstructed by sun glare
- Street light or light from an oncoming traffic is reflected on the wet road surface, such as a puddle on the road
- An object is placed on the dashboard
- Your vehicle is being towed
- The surrounding is very bright or the surrounding is very dark, such as in a tunnel, etc.
- The brightness changes suddenly, for example when entering or exiting a tunnel
- The brightness outside is low, and the headlamps are not on or are not bright
- Only part of the vehicle, powered two-wheeler, pedestrian or cyclist is detected

- The vehicle or powered two-wheeler in front is a bus, heavy truck, truck with an unusually shaped cargo, trailer, etc.
- The vehicle or powered two-wheeler in front has no tail lights, tail lights are located unusually, etc.
- The brightness outside is low, and the tail lamps are not on or are not bright
- The rear of the front vehicle is small or the vehicle does not look normal, such as when the vehicle is tilted, over-turned, or the side of the vehicle is visible, etc.
- The front vehicle's ground clearance is low or high
- A vehicle, powered two-wheeler, pedestrian or cyclist suddenly cuts in front
- The bumper around the front radar is impacted, damaged or the front radar is out of position
- The temperature around the front radar is high or low
- Driving through a tunnel or iron bridge
- Driving in vast areas where there are few vehicles or structures (for example, desert, meadow, suburb, etc.)
- Driving near areas containing metal substances, such as a construction zone, railroad, etc.
- A material is near that reflects very well on the front radar, such as a guardrail, nearby vehicle, etc.
- The cyclist in front is on a bicycle made of material that does not reflect on the front radar
- The vehicle or powered two-wheeler in front is detected late
- The vehicle or powered two-wheeler in front is suddenly blocked by an obstacle
- The vehicle or powered two-wheeler in front suddenly changes lane or suddenly reduces speed
- The vehicle or powered two-wheeler in front is bent out of shape
- The front vehicle or powered two-wheeler speed is fast or slow
- The vehicle or powered two-wheeler in front steers in the opposite direction of your vehicle to avoid a collision
- With a vehicle or powered two-wheeler in front, your vehicle changes lane at low speed
- The vehicle in front is covered with snow
- You are departing or returning to the lane
- Unstable driving
- You are on a roundabout and the vehicle or powered two-wheeler in front is not detected
- You are continuously driving in a circle
- The vehicle in front has an unusual shape
- The vehicle in front is driving uphill or downhill
- The pedestrian or cyclist is not fully detected, for example, if the pedestrian is leaning over or is not fully walking upright
- The pedestrian or cyclist is wearing clothing or equipment that makes it difficult to detect





The illustration above shows the image the front view camera and front radar are capable of detecting as a vehicle, powered two-wheeler, pedestrian and cyclist.

- The pedestrian or cyclist in front is moving very quickly
- The pedestrian or cyclist in front is short or is posing a low posture
- The pedestrian or cyclist in front has impaired mobility or moving intersected with the driving direction
- There is a group of pedestrians, cyclists or a large crowd in front
- The pedestrian or cyclist is wearing clothing that easily blends into the background, making it difficult to detect
- The pedestrian or cyclist is difficult to distinguish from the similarly shaped structure in the surroundings
- You are driving by a pedestrian, cyclist, traffic signs, structures, etc., near the intersection
- When driving in the following places
  - Driving through steam, smoke or shadow
  - Driving through a tunnel or iron bridge
  - Driving in large areas where there are few vehicles or structures (i.e. desert, meadow, suburb, etc.)
  - Driving in a parking lot

- Driving through toll gate, construction areas, partially paved roads, bumpy roads, speed bumps, etc.
- Driving near areas containing metal substances, such as a construction zone, railroad, etc.
- Driving on an incline road, curved road, etc.
- Driving through a roadside with trees or streetlights
- Driving through a narrow road where trees or grass are overgrown
- There is interference by electromagnetic waves, such as driving in an area with strong radio waves or electrical noise
- The adverse road conditions cause excessive vehicle vibrations while driving
- Your vehicle height is low or high due to heavy loads, abnormal tire pressure, etc.

### **⚠ WARNING**

- Driving on a curved road



Forward Collision-Avoidance Assist may not detect other vehicles, powered two-wheelers, pedestrians or cyclists in front of you when driving on curved roads adversely affecting the performance of the sensors. This may result in no warning, braking assist when necessary.

When driving on a curve, you must maintain a safe braking distance, and if necessary, steer the vehicle and

depress the brake pedal to reduce your driving speed in order to maintain a safe distance.



OSG2EV051081\_4

Forward Collision-Avoidance Assist may detect a vehicle, powered two-wheeler, pedestrian or cyclist in the next lane or outside the lane when driving on a curved road.

If this occurs, Forward Collision-Avoidance Assist may unnecessarily warn the driver and control the brake. Always check the traffic conditions around the vehicle.

- Driving on an inclined road



OSG2EV051082\_4

Forward Collision-Avoidance Assist may not detect other vehicles, powered two-wheelers, pedestrians or cyclists in front of you while driving uphill or downhill, adversely affecting the performance of the sensors.

This may result in unnecessary warning, braking assist or no warning, braking assist when necessary.

Also, vehicle speed may rapidly decrease when a vehicle, powered two-wheeler, pedestrian or cyclist ahead is suddenly detected.

Always have your eyes on the road while driving uphill or downhill and if

necessary, steer your vehicle and depress the brake pedal to reduce your driving speed in order to maintain a safe distance.

- Changing lanes



OSG2PH052078L

[A]: Your vehicle,

[B]: Lane changing vehicle

When a vehicle (B) moves into your lane from an adjacent lane, it cannot be detected by the sensor until it is in the sensor's detection range.

Forward Collision-Avoidance Assist may not immediately detect the vehicle when the vehicle changes lanes abruptly. In this case, you must maintain a safe braking distance, and if necessary, steer your vehicle and depress the brake pedal to reduce your driving speed in order to maintain a safe distance.



[A]: Your vehicle,  
 [B]: Lane changing vehicle,  
 [C]: Same lane vehicle

When a vehicle (B) in front of you merges out of the lane, Forward Collision-Avoidance Assist may not immediately detect the vehicle (C) that is now in front of you. In this case, you must maintain a safe braking distance, and if necessary, steer your vehicle and depress the brake pedal to reduce your driving speed in order to maintain a safe distance.

- Detecting vehicle



If the vehicle in front of you has cargo that extends rearward from the cab,

or when the vehicle in front of you has higher ground clearance, additional special attention is required. Forward Collision-Avoidance Assist may not be able to detect the cargo extending from the vehicle. In these instances, you must maintain a safe braking distance from the rearmost object, and if necessary, steer your vehicle and depress the brake pedal to reduce your driving speed in order to maintain distance.

**⚠ WARNING**

- When you are towing a trailer or another vehicle, turn off Forward Collision-Avoidance Assist for safety reasons.
- Forward Collision-Avoidance Assist may operate if objects that are similar in shape or characteristics to vehicles, powered two-wheeler, pedestrians and cyclists are detected.
- Forward Collision-Avoidance Assist does not operate on bicycles, or smaller wheeled objects, such as luggage bags, shopping carts, or strollers.
- Forward Collision-Avoidance Assist may not operate properly if interfered by strong electromagnetic waves.
- Forward Collision-Avoidance Assist may not operate for 15 seconds after the vehicle is started, or the front view camera is initialized.

**This device complies with Industry Canada licence-exempt RSS standard(s).**

Operation is subject to the following conditions:

1. This device may not cause interference, and
2. This device must accept any interference, including interference that may cause undesired operation of the device.
3. Changes or modifications not expressly approved by the party responsible for compliance could void the user's authority to operate the device.

## Lane Keeping Assist (LKA)

Lane Keeping Assist is designed to help detect lane markings (or road edges) while driving over a certain speed. Lane Keeping Assist will warn the driver if the vehicle leaves the lane without using the turn signal, or will automatically assist the driver's steering to help prevent the vehicle from departing the lane.

### Detecting sensor

Front view camera



The front view camera is used as a detecting sensor to detect lane markings (or road edges).

Refer to the picture above for the detailed location of the detecting sensor.

### **⚠ CAUTION**

For more details on the precautions of the front view camera, refer to "Forward Collision-Avoidance Assist (FCA) (Front Camera Only) (if equipped)" on page 6-58.

## Lane Keeping Assist settings

### Lane safety

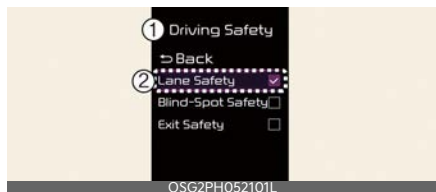



## A: Driver Assistance

### 1 Driving Safety

### 2 Lane Safety

With the vehicle on, touch **Settings** → **Driver Assistance** → **Driving Safety** on the instrument cluster or **Settings** → **Vehicle** → **Driver Assistance** → **Driving Safety** on the infotainment system.

- **Lane Safety:** If Lane safety is selected, Lane Keeping Assist will automatically assist the driver's steering when lane departure is detected to help prevent the vehicle from moving out of its lane. If Lane safety is deselected, the indicator light (🚗) will be turned off.

## ⚠ WARNING

- Lane Keeping Assist does not control the steering wheel when the vehicle is driven in the middle of the lane.
- The driver should always be aware of the surroundings and steer the vehicle if **Lane Safety** is deselected.

## \* INFORMATION

The infotainment system may change after software updates. For more information, refer to the user's manual provided in the infotainment system and the quick reference guide.

## Warning Sound and Haptic



## A: Driver Assistance

### 1 Warning Sound and Haptic

### 2 Warning Volume

### 3 Driving Safety Priority

With the vehicle on, touch **Settings** → **Vehicle** → **Driver Assistance** → **Warning Style** on the infotainment system to change the Warning Style.

- **Warning Volume:** You can adjust the Warning Volume from level 1 to 3. If equipped with steering wheel vibration, the volume level can be set from 0 to 3.
- **Driving Safety Priority:** For safe driving, the audio volume will temporarily decrease to warn the driver with the audible warning.

## \* NOTICE

- Ensure that Warning Style you have set may apply to the Warning volume of other Driver Assistance systems.
- Warning Style will maintain its last setting even if the vehicle is restarted.
- If not equipped with the navigation system, select **User Settings** → **Driver Assistance** to adjust the Warning Volume.
- The setting menu may not be available for your vehicle depending on the vehicle features and specifications.
- Descriptions of each Driver Assistance system may be slightly different from

the owner's manual after updating the software of your infotainment system. In this case, scan the QR code in the infotainment system manual to access the web manual for checking the changes.

### Lane Keeping Assist operation

#### Turning Lane Keeping Assist On/Off



- With the vehicle ON, press and hold the Lane Driving Assist button to turn on/off Lane Keeping Assist. If Lane Keeping Assist is activated, the indicator (🚗) will be displayed on the cluster.

#### \* NOTICE

- When the Lane Driving Assist button is pressed shortly, Lane Following Assist will turn on and off.
- Whenever the vehicle is turned off and on, Lane safety settings will always retain its settings.

#### Warning and control

Left



Right



Lane Keeping Assist will warn and help control the vehicle with Lane Departure Warning and Lane Keeping Assist.

#### Lane Departure Warning

The green (🚗) indicator light and the lane line depending on which direction the vehicle is veering will blink on the cluster.

An audible warning will sound to warn the driver that the vehicle is departing from the projected lane in front.

Lane departure warning will be activated in the following conditions.

- Your driving speed: Approximately 60~200 km/h (40~120 mph)

#### Lane Keeping Assist

The green (🚗) indicator light will blink on the cluster, and the steering wheel will make adjustments to warn the driver that the vehicle is departing from the projected lane in front.

Lane Keeping Assist will be activated in the following conditions.

- Your driving speed: Approximately 60~200 km/h (40~120 mph)

#### Hands-off warning



**A: Keep hands on steering wheel**

If the driver takes their hands off the steering wheel for several seconds, the warning message will appear on the cluster, and an audible warning will sound in stages.

**⚠ WARNING**

- The steering wheel may not be assisted if the steering wheel is held very tight or the steering wheel is steered over a certain degree.
- Lane Keeping Assist does not operate at all times. It is the responsibility of the driver to safely steer the vehicle and to maintain the vehicle in its lane.
- The hands-off warning message may appear late depending on road conditions. Always have your hands on the steering wheel while driving.
- If the steering wheel is held very lightly, the hands-off warning message may appear because Lane Keeping Assist may not recognize that the driver has their hands on the steering wheel.
- If you attach objects to the steering wheel, the hands-off warning may not work properly.

**\* NOTICE**

- For more details on setting the functions in the infotainment system Vehicle Settings, refer to "Vehicle settings (infotainment system) (if equipped)" on page 5-91.
- When lane markings (or road edges) are detected, the lane lines on the cluster will change from grey to white and the green (🚗) indicator light will appear.

- When lane markings (or road edges) are detected, the green lane lines on the cluster may appear.

Lane undetected



Lane detected



- The images and colors in the instrument cluster may differ depending on the cluster type or theme selected from the settings menu.
- Even though the steering is assisted by Lane Keeping Assist, the driver may control the steering wheel.
- The steering wheel may feel heavier or lighter when the steering wheel is assisted by Lane Keeping Assist than when it is not.

6

**Lane Keeping Assist malfunction and limitations**

**Lane Keeping Assist malfunction**

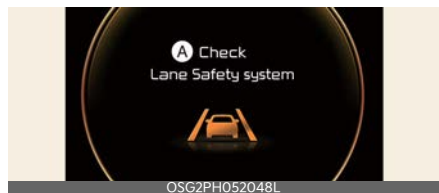

**A: Check Lane Safety system**

When Lane Keeping Assist is not working properly, the warning message will appear and the yellow  indicator light will appear on the cluster. If this occurs, have the function inspected by an authorized Kia dealer.

### Limitations of Lane Keeping Assist

Lane Keeping Assist may not operate properly or may operate unexpectedly under the following circumstances:

- The lane is contaminated or difficult to detect because:
  - The lane markings (or road edge) are covered with rain, snow, dirt, oil, etc.
  - The color of the lane marking (or road edge) is not distinguishable from the road
  - There are markings (or road edges) on the road near the lane or the markings (or road edges) on the road look similar to the lane markings (or road edge)
  - The lane marking (or road edge) is indistinct or damaged
  - The shadow is on the lane marking (or road edge) by a median strip, trees, guardrail, noise barriers, etc.
- The lane number increases or decreases, or the lane markings (or road edges) are crossing
- There are more than two lane markings (or road edges) on the road
- The lane markings (or road edges) are complicated or a structure substitutes for the lines, such as a construction area
- There are road markings, such as zig-zag lanes, crosswalk markings and road signs

- The lane suddenly disappears, such as at the intersection
- The lane (or road width) is very wide or narrow
- There is a road edge without a lane
- There is a boundary structure in the roadway, such as a tollgate, sidewalk, curb, etc.
- The distance to the front vehicle is extremely short or the vehicle in front is covering the lane marking (or road edge)

#### \* NOTICE

For more details on the limitations of the front view camera, refer to "Forward Collision-Avoidance Assist (FCA) (Front Camera Only) (if equipped)" on page 6-58.

#### ⚠ WARNING

- The driver should hold the responsibility to safely drive and control the vehicle. Do not solely rely on Lane Keeping Assist and drive dangerously.
- The operation of Lane Keeping Assist can be canceled or not work properly depending on road conditions and surroundings. Always be cautious while driving.
- Refer to "Limitations of Lane Keeping Assist" if the lane is not detected properly.
- When you are towing a trailer or another vehicle, turn off Lane Keeping Assist for safety reasons.
- If the vehicle is driven at high speed, the steering wheel will not be controlled. The driver must always follow the speed limit when using Lane Keeping Assist.



- If any other function's warning message is displayed or audible warning is generated, Lane Keeping Assist warning message may not be displayed and audible warning may not be generated.
- You may not hear the warning sound of Lane Keeping Assist if the surrounding is noisy. Adjust the vehicle volume moderately and always pay attention to the surrounding.
- If you attach objects to the steering wheel, steering may not be assisted properly.
- Lane Keeping Assist may not operate for 15 seconds after the vehicle is started, or the front view camera is initialized.
- Lane Keeping Assist will not operate when:
  - The turn signal or hazard warning flasher is turned on.
  - The vehicle is not driven in the center of the lane when Lane Keeping Assist is turned on or right after changing a lane.
  - ESC (Electronic Stability Control) or VSM (Vehicle Stability Management) is activated.
  - The vehicle is driven rapidly on a sharp curve.
  - Vehicle speed is below 55 km/h (35 mph) or above 210 km/h (130 mph).
  - The vehicle makes sharp lane changes.
  - The vehicle brakes suddenly.

## Blind-Spot Collision-Avoidance Assist (BCA) (if equipped)

Blind-Spot Collision-Avoidance Assist is designed to help detect and monitor approaching vehicles in the driver's blind spot area and warn the driver of a possible collision with a warning message and audible warning.

In addition, if there is a risk of collision when driving forward out of a parking space, Blind-Spot Collision-Avoidance Assist can help avoid a collision assisting with applying the brake.



Blind-Spot Collision-Avoidance Assist helps detect and informs the driver that a vehicle is in the blind spot.

### ⚠ CAUTION

The detecting range may vary depending on the speed of your vehicle. Even if there is a vehicle in the blind spot area, Blind-Spot Collision-Avoidance Assist may not warn you when you pass by at high speeds.



Blind-Spot Collision-Avoidance Assist helps detect and informs the driver that a vehicle is approaching at high speed from the blind spot area.

**CAUTION**

Warning timing may vary depending on the speed of the vehicle approaching at high speed.



When you are driving forward out of a parking space, if Blind-Spot Collision-Avoidance Assist judges that there is a collision risk with an approaching vehicle in the blind spot, it can help avoid collision by applying the brake.

**Detecting sensor**

Rear corner radar



Refer to the picture above for the detailed location of the detecting sensors.

**CAUTION**

- Never disassemble the detecting sensor assembly, or cause any damage to it.
- If the detecting sensor or near the sensor has been damaged or impacted in any way, even though the warning message does not appear on the cluster, Blind-Spot Collision-Avoidance Assist may not operate properly.

Have the function be inspected by an authorized Kia dealer.

- If the detecting sensors have been replaced or repaired, have the vehicle inspected by an authorized Kia dealer.
- The genuine Kia rear bumpers which the Rear corner radar sensors are mounted are parts with quality and performance ensured. If arbitrarily applying paint on or changing the bumper, the Blind-Spot Collision-Avoidance Assist may not function properly.  
Use only Kia Genuine Parts or those of an equivalent standard with proven quality and performance to repair or replace the bumper.
- Do not arbitrarily attach or add vehicle wraps, accessories, license plate molds and stickers on or around the rear corner radar.
- If a trailer, carrier, etc., is installed, it may adversely affect the performance of the rear corner radar or Blind-Spot Collision-Avoidance Assist may not operate.

**Blind-Spot Collision-Avoidance Assist settings**

**Blind-spot safety**





**A: Driver Assistance**

**1 Driving Safety**

**2 Blind-Spot Safety**

With the vehicle on, touch **User Settings** → **Driver Assistance** → **Driving Safety** → **Blind-Spot Safety** on the instrument cluster or **Settings** → **Vehicle** → **Driver Assistance** → **Driving Safety** → **Blind-Spot Safety** on the infotainment system.

- **Blind-Spot Safety:** Blind-Spot Collision-Avoidance Assist will warn you with a warning message and an audible warning depending on the collision risk level while driving, and will provide emergency braking depending on the collision risk level for parallel parking exit.



**A: Blind-Spot Safety System is Off**

When activating Blind-Spot Collision-Avoidance Assist or restarting the vehicle with this function activated, the warning light on the side mirrors will appear for approximately 3 seconds.

When the vehicle is restarted with Blind-Spot Collision-Avoidance Assist inactivated, the warning message will appear on the cluster.

**⚠ WARNING**

If **Blind-Spot Safety** is deselected, the driver should always be aware of the surroundings and drive safely.

**\* NOTICE**

If the vehicle is restarted, Blind-Spot Collision-Avoidance Assist will maintain the last setting.

**\* INFORMATION**

The infotainment system may change after software updates. For more information, refer to the user's manual provided in the infotainment system and the quick reference guide.

**Warning Sound and Haptic**

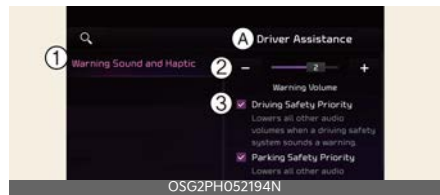

**A: Driver Assistance**

**1 Warning Sound and Haptic**

**2 Warning Volume**

**3 Driving Safety Priority**

With the vehicle on, touch **Settings** → **Vehicle** → **Driver Assistance** → **Warning Style** on the infotainment system to change the Warning Style.

- **Warning Volume:** You can adjust the Warning Volume from level 1 to 3. If equipped with steering wheel vibration, the volume level can be set from 0 to 3.
- **Driving Safety Priority:** For safe driving, the audio volume will temporarily

decrease to warn the driver with the audible warning.

**\* NOTICE**

- Ensure that Warning Style you have set may apply to the Warning volume of other Driver Assistance systems.
- Warning Style will maintain its last setting even if the vehicle is restarted.
- If not equipped with the navigation system, select **User Settings** → **Driver Assistance** to adjust the Warning Volume.
- The setting menu may not be available for your vehicle depending on the vehicle features and specifications.
- Descriptions of each Driver Assistance system may be slightly different from the owner's manual after updating the software of your infotainment system. In this case, scan the QR code in the infotainment system manual to access the web manual for checking the changes.

**Blind-Spot Collision-Avoidance Assist operation**

Blind-Spot Collision-Avoidance Assist will warn and control as following action.

- Vehicle detection
- Collision warning
- Collision-avoidance assist (while departing)

**Vehicle detection**

First warning (Left/Right)



The warning light on the outside rear view mirror (side view mirror) and head-up display (if equipped) will appear when the vehicle on both lanes is detected from the rear.

A vehicle is detected in the following conditions.

- Your driving speed: Above 20 km/h (12 mph)
- The speed of the vehicle in your blind spot area: Above 10 km/h (7 mph)

**Collision warning**

With the vehicle detection state, Collision warning will alert the driver when the turn signal is activated to make a lane change with an adjacent car in the blind spot area.

- Collision warning will alert the driver with the warning light on the outside rear view mirrors (side view mirrors) and head-up display (if equipped) and an audible warning.
- When the turn signal is turned off or you move away from the lane, the collision warning will be canceled and

the function will return to Vehicle detection state.

**⚠ WARNING**

- The detecting range of the front corner radar or rear corner radar is determined by a standard road width, therefore, on a narrow road, Blind-Spot Collision-Avoidance Assist may detect other vehicles two lanes over and warn you. In contrast, on a wide road, Blind-Spot Collision-Avoidance Assist may not be able to detect a vehicle driving in the next lane and may not warn you.
- When the hazard warning flasher is on, the collision warning by the turn signal will not operate.

**\* NOTICE**

Images or colors may be displayed differently depends on the instrument cluster specifications or theme.

**Collision-avoidance assist (Parallel Exit)**



**A: Emergency Braking**

The warning light on the outside rear view mirror (side view mirror), head-up display (if equipped) and an audible warning will warn the driver of a collision. It assists in braking control to prevent a collision with a vehicle approaching from the blind spot area.

Collision-Avoidance Assist will be activated in the following conditions.

- Your driving speed: Below 3 km/h (2 mph)
- Speed of the vehicle in your blind spot area: Above 5 km/h (3 mph)



**A: Drive carefully**

When the vehicle is stopped due to emergency braking, the warning message will appear on the cluster. For your safety, the driver should depress the brake pedal immediately and check the surroundings.

- Brake control will end after the vehicle is stopped by emergency braking for approximately 2 seconds.

**⚠ WARNING**

- For your safety, change the Settings after parking the vehicle at a safe location.
- If any other system's warning message is displayed or audible warning is generated, Blind-Spot Collision-Avoidance Assist's warning message may not be displayed and audible warning may not be generated.
- You may not hear the warning sound of Blind-Spot Collision-Avoidance Assist if the surrounding is noisy.
- Blind-Spot Collision-Avoidance Assist may not operate if the driver applies the brake pedal to avoid collision.
- When Blind-Spot Collision-Avoidance Assist is operating, braking control by the function will automatically cancel

when the driver excessively depresses the accelerator pedal or sharply steers the vehicle.

- During Blind-Spot Collision-Avoidance Assist operation, the vehicle may stop suddenly injuring passengers and shifting loose objects. Always have the seat belt on and keep loose objects secured.
- Even if there is a problem with Blind-Spot Collision-Avoidance Assist, the vehicle's basic braking performance will operate properly.
- Blind-Spot Collision-Avoidance Assist does not operate in all situations or cannot avoid all collisions.
- Blind-Spot Collision-Avoidance Assist may warn the driver late or may not warn the driver depending on the road and driving conditions.
- Driver should maintain control of the vehicle at all times. Do not depend on Blind-Spot Collision-Avoidance Assist. Maintain a safe braking distance, and if necessary, depress the brake pedal to reduce driving speed or to stop the vehicle.
- Never operate Blind-Spot Collision-Avoidance Assist on people, animal, objects, etc. It may cause serious injury or death.

**⚠ WARNING**

The brake control may not operate properly depending on the status of ESC (Electronic Stability Control).

There will only be a warning when:

- The ESC (Electronic Stability Control) warning light is on
- ESC (Electronic Stability Control) is engaged in a different function

**Blind-Spot Collision-Avoidance Assist malfunction and limitations**

**Blind-Spot Collision-Avoidance Assist malfunction**



**A: Check Blind-Spot Safety system**

When Blind-Spot Collision-Avoidance Assist is not working properly, the warning message will appear on the cluster for several seconds, and the master (⚠) warning light will appear on the cluster for several seconds. If this occurs, have Blind-Spot Collision-Avoidance Assist be inspected by an authorized Kia dealer.

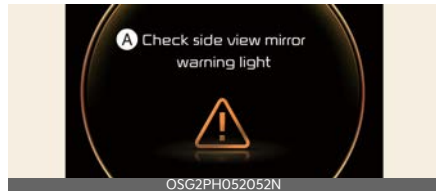

**A: Check side view mirror warning light**

When the outside rearview mirror warning light is not working properly, the warning message will appear on the cluster for several seconds, and the master (⚠) warning light will appear on the cluster. If this occurs, have Blind-Spot Collision-Avoidance Assist be inspected by an authorized Kia dealers.

## Blind-Spot Collision-Avoidance Assist disabled



### A: Blind-Spot Safety system disabled. Radar blocked

When the rear bumper around the rear corner radar or sensor is covered with foreign material, such as snow or rain, or installing a trailer or carrier, it can reduce the detecting performance and temporarily limit or disable Blind-Spot Collision-Avoidance Assist.

If this occurs, the warning message will appear on the cluster.

Blind-Spot Collision-Avoidance Assist will operate properly when such foreign material or trailer, etc., is removed, and then the vehicle is restarted.

If Blind-Spot Collision-Avoidance Assist does not operate properly after it is removed, have Blind-Spot Collision-Avoidance Assist be inspected by an authorized Kia dealer.

### ⚠ WARNING

- Even though the warning message does not appear on the cluster, Blind-Spot Collision-Avoidance Assist may not properly operate.
- Blind-Spot Collision-Avoidance Assist may not properly operate in an area (for example, open terrain) where any objects are not detected right after the vehicle is turned on, or when the detecting sensor is blocked with foreign material right after the vehicle is turned on.

### ⚠ CAUTION

Turn off Blind-Spot Collision-Avoidance Assist to install or remove a trailer, carrier, or another attachment. Turn on Blind-Spot Collision-Avoidance Assist when finished.

## Limitations of Blind-Spot Collision-Avoidance Assist

Blind-Spot Collision-Avoidance Assist may not operate properly, or it may operate unexpectedly under the following circumstances:

- There is inclement weather, such as heavy snow, heavy rain, etc.
- The detecting sensor is covered with snow, rain, dirt, etc.
- The temperature around the detecting sensor is high or low due to surrounding environment.
- The detecting sensor is blocked while driving near a vehicle, pillar, or wall.
- Driving on a highway (or motorway) ramp or driving through a tollgate.
- The road pavement (or the peripheral ground) abnormally contains metallic components (for example, possibly due to subway construction).
- There is a fixed object near the vehicle, such as sound barriers, guardrails, central dividers, entry barriers, street lamps, signs, tunnels, walls, etc. (including double structures)
- Driving through a narrow road where trees or grass are overgrown
- Driving in vast areas where there are few vehicles or structures (for example, desert, meadow, suburb, etc.)
- Driving on a wet road surface, such as a puddle on the road

- The other vehicle drives very close behind your vehicle, or the other vehicle passes by your vehicle in close proximity
- The speed of the other vehicle is very fast that it passes by your vehicle in a short time
- Your vehicle passes by the other vehicle
- Your vehicle changes lane
- Your vehicle has started at the same time as the vehicle next to you and has accelerated
- The vehicle in the next lane moves two lanes away from you, or when the vehicle two lanes away moves to the next lane from you
- A trailer or carrier is installed around the rear corner radar
- The bumper around the rear corner radar is covered with objects, such as a bumper sticker, bike rack, etc.
- The bumper around the rear corner radar is impacted, damaged or the radar is out of position
- Your vehicle height is low or high due to heavy loads, abnormal tire pressure, etc.
- When the following objects are detected:
  - A motorcycle or bicycle is detected
  - A vehicle such as a flat trailer is detected
  - A big vehicle such as a bus or truck is detected
  - A moving obstacle such as a pedestrian, animal, shopping cart or a baby stroller is detected
  - A vehicle with low height such as a sports car is detected

Braking control may not work, driver's attention is required in the following circumstances:

- The vehicle severely vibrates while driving over a bumpy road, uneven road or concrete patch
- Driving on a slippery surface due to snow, water puddle, ice, etc.
- The tire pressure is low or a tire is damaged
- The braking system has been modified
- The vehicle makes abrupt lane changes

**WARNING**

- Driving on a curved road



Blind-Spot Collision-Avoidance Assist may not operate properly when driving on a curved road. Blind-Spot Collision-Avoidance Assist may not detect the vehicle in the next lane.

Always pay attention to road and driving conditions while driving.



Blind-Spot Collision-Avoidance Assist may not operate properly when driving on a curved road. Blind-Spot Collision-Avoidance Assist may detect a vehicle in the same lane.



Always pay attention to road and driving conditions while driving.

- Driving on an inclined road



Blind-Spot Collision-Avoidance Assist may not operate properly when driving on a slope. The function may not detect the vehicle in the next lane or may incorrectly detect the ground or structure.

Always pay attention to road and driving conditions while driving.

- Driving where the road is merging/dividing



Blind-Spot Collision-Avoidance Assist may not operate properly when driving where the road merges or divides. The function may not detect the vehicle in the next lane.

Always pay attention to road and driving conditions while driving.

- Driving where the heights of the lanes are different



Blind-Spot Collision-Avoidance Assist may not operate properly when driving where the heights of the lanes are different. The function may not detect the vehicle on a road with different lane heights (underpass joining section, grade separated intersections, etc.).

Always pay attention to road and driving conditions while driving.

### **⚠ WARNING**

- When you are towing a trailer or another vehicle, make sure that you turn off Blind-Spot Collision-Avoidance Assist.
- Blind-Spot Collision-Avoidance Assist may not operate properly if interfered by strong electromagnetic waves.
- Blind-Spot Collision-Avoidance Assist may not operate for 3 seconds after the vehicle is started, or the front view camera or rear corner radars are initialized.

### **This device complies with Industry Canada licence-exempt RSS standard(s).**

Operation is subject to the following two conditions:

1. This device may not cause interference, and

- 2. This device must accept any interference, including interference that may cause undesired operation of the device.

### Safe Exit Warning (SEW) (if equipped)



After the vehicle stops, when an approaching vehicle from the rear area is detected as soon as a passenger opens a door, Safe Exit Warning will warn the driver with a warning message and an audible warning to help prevent a collision.

#### **⚠ CAUTION**

Warning timing may vary depending on the speed of the approaching vehicle.

### Detecting sensor

Rear corner radar



Refer to the picture above for the detailed location of the detecting sensors.

#### **⚠ CAUTION**

For more details on the precautions of the rear corner radars, refer to "Blind-Spot Collision-Avoidance Assist (BCA) (if equipped)" on page 6-85.

## Safe Exit Warning settings

### Setting features

#### Exit Safety



#### A: Driver Assistance

##### 1 Driving Safety

##### 2 Exit Safety

With the vehicle on, touch **Settings** → **Driver Assistance** → **Driving safety** → **Exit Safety** on the instrument cluster or **Settings** → **Vehicle** → **Driver Assistance** → **Driving Safety** → **Exit Safety** on the infotainment system.

#### **⚠ WARNING**

If **Exit Safety** is deselected, Safe Exit Warning cannot warn you. The driver should always be aware of unexpected and sudden situations from occurring.

#### **\* NOTICE**

If the vehicle is restarted, Safe Exit Warning will maintain the last setting.

#### **\* INFORMATION**

The infotainment system may change after software updates. For more information, refer to the user's manual pro-

vided in the infotainment system and the quick reference guide.

#### Safe Exit Warning operation

Safe Exit Warning warns the following actions.

- Collision warning when exiting vehicle

#### Collision warning when exiting vehicle



#### A: Watch for traffic

The warning light on the side view mirror will blink and the warning message will appear on the cluster, and an audible warning will sound.

- Safe Exit Warning will warn under the following circumstances:
  - Your driving speed: below 3 km/h (2 mph)
  - The speed of the approaching vehicle from the rear: above 6 km/h (4 mph)

#### **⚠ WARNING**

- For your safety, change the Settings after parking the vehicle at a safe location.
- If any other function's warning message is displayed or audible warning

is generated, Safe Exit Warning warning message may not be displayed and audible warning may not be generated.

- You may not hear the warning sound of Safe Exit Warning if the surrounding is noisy.
- Safe Exit Warning does not operate in all situations or cannot prevent all collisions.
- Safe Exit Warning may warn the driver late or may not warn the driver depending and driving conditions. Always check vehicle surroundings.
- The driver and passengers are responsible for accidents that occurs while exiting the vehicle. Always check the surroundings before you exit the vehicle.

**\* NOTICE**

- After the vehicle is turned off, Safe Exit Warning operates for approximately 3 minutes, but turns off immediately if the doors are locked.
- Images or colors may be displayed differently depends on the instrument cluster specifications or theme.

**Safe Exit Warning malfunction and limitations**

**Safe Exit Warning malfunction**

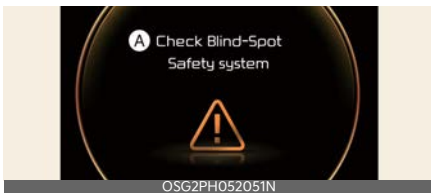

**A: Check Blind-Spot Safety system**  
When Safe Exit Warning is not working properly, the warning message will

appear on the cluster for several seconds, and the master warning light (⚠) will appear on the cluster. Have Safe Exit Warning be inspected by an authorized Kia dealer.

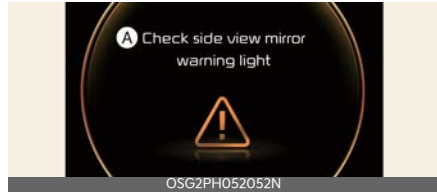

**A: Check side view mirror warning light**

When the outside rear view mirror warning light is not working properly, the warning message will appear on the cluster for several seconds, and the master warning light (⚠) will appear on the cluster. Have Safe Exit Warning be inspected by an authorized Kia dealer.

**Safe Exit Warning disabled**

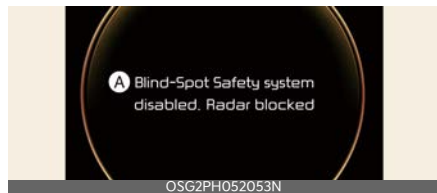

**A: Blind-Spot Safety system disabled. Radar blocked**

When the rear bumper around the rear corner radar or sensor is covered with foreign material, such as snow or rain, or installing a trailer or carrier, it can reduce the detecting performance and temporarily limit or disable Safe Exit Warning. If this occurs, the **Blind-Spot Safety systems disabled. Radar blocked** warning message will appear on the cluster.

Safe Exit Warning will operate normally when such foreign material or trailer, etc. is removed, and then the vehicle is restarted.

If Safe Exit Warning does not operate normally after it is removed, have the vehicle inspected by an authorized Kia dealer.

### **⚠ WARNING**

- Even though the warning message does not appear on the cluster, Safe Exit Warning may not properly operate.
- Safe Exit Warning may not properly operate in an area (e.g., open terrain), where any substance are not detected right after the vehicle is turned on, or when the detecting sensor is blocked with foreign material right after the vehicle is turned on.

### **⚠ CAUTION**

Turn off Safe Exit Warning to install a trailer, carrier, etc., or remove the trailer, carrier, etc. to use Safe Exit Warning.

### **Limitations of Safe Exit Warning**

Safe Exit Warning may not operate normally, or Safe Exit Warning may operate unexpectedly under the following warning.

- Getting out of the vehicle where trees or grass are overgrown
- Getting out of the vehicle where the road is wet
- The approaching vehicle is very fast or very slow

### **\* NOTICE**

For more details on the precautions of the rear corner radars, refer to "Blind-

Spot Collision-Avoidance Assist (BCA (if equipped))" on page 6-85.

### **⚠ WARNING**

- Safe Exit Warning may not operate normally if interfered by strong electromagnetic waves.
- Safe Exit Warning may not operate for approximately 3 seconds after the vehicle is restarted, or the rear corner radars are initialized.

## Safe Exit Assist (SEA) (if equipped)



After the vehicle stops, when an approaching vehicle from the rear area is detected after a passenger opens the door, Safe Exit Assist will warn the driver with a warning message and an audible warning to help prevent a collision.



When the electronic child safety lock button is in the LOCK position and an approaching vehicle from the rear area is detected, the electronic child safety lock (🚫) button will not unlock even if the driver presses the button to prevent the rear doors from opening.

### ⚠ CAUTION

Warning timing may vary depending on the speed of the approaching vehicle.

## Detecting sensor

Rear corner radar



Refer to the picture above for the detailed location of the detecting sensors.

### ⚠ CAUTION

For more details on the precautions of the rear corner radars, refer to "Blind-Spot Collision-Avoidance Assist (BCA (if equipped))" on page 6-85.

## Safe Exit Assist settings

### Exit Safety

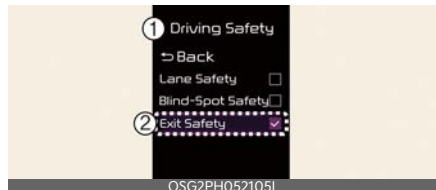

#### A: Driver Assistance

#### 1 Driving Safety

#### 2 Exit Safety

With the vehicle on, touch **Settings** → **Vehicle** → **Driver Assistance** → **Driving Safety** → **Exit Safety** on the instrument cluster or **Settings** → **Vehicle** → **Driver**

**Assistance → Driving Safety → Exit Safety** on the infotainment system.

### ⚠️ WARNING

The driver should always be aware of his or her surroundings. If **Exit Safety** is deselected, Safe Exit Assist cannot assist you.

### \* NOTICE

If the vehicle is restarted, Safe Exit Assist will maintain the last setting.

### \* INFORMATION

The infotainment system may change after software updates. For more information, refer to the user's manual provided in the infotainment system and the quick reference guide.

## Safe Exit Assist operation

Safe Exit Assist warns the following actions.

- Collision warning when exiting vehicle
- Safe Exit Assist linked with Electronic child safety lock

## Collision warning when exiting vehicle



### A: Watch for traffic

The warning light on the side view mirror will blink and the warning message will appear on the cluster, and an audible warning will sound.

- Collision warning when exiting vehicle will warn under the following circumstances:
  - Your driving speed: below 3 km/h (2 mph)
  - The speed of the approaching vehicle from the rear: above 6 km/h (4 mph)

## Safe Exit Assist linked with Electronic child safety lock

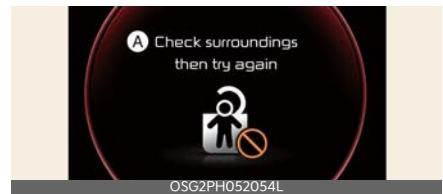

### A: Check surroundings then try again

The warning light on the outside rear view mirror will blink and the warning message will appear on the cluster.

- Safe Exit Assist linked with Electronic child safety lock will operate in the following conditions:
  - Your driving speed: below 3 km/h (2 mph)
  - The speed of the approaching vehicle from the rear: above 6 km/h (4 mph)

**\* NOTICE**

For more details on electric child safety lock button, refer to "Electronic child safety lock system (if equipped)" on page 5-16.

**⚠ WARNING**

If the driver presses the electronic child safety lock button again within 10 seconds after the warning message appears, Safe Exit Assist judges that the driver has unlocked the doors acknowledging the rear status. The electronic child safety lock will turn off (button indicator OFF) and the rear doors will unlock. Always check the surroundings before turning off the electronic child safety lock button.

**\* NOTICE**

If a rear door is opened from the outside, it will open regardless of Safe Exit Assist operation.

**⚠ WARNING**

- For your safety, change the Settings after parking the vehicle at a safe location.
- If any other function's warning message is displayed or audible warning is generated, Safe Exit Assist warning message may not be displayed and

audible warning may not be generated.

- You may not hear the warning sound of Safe Exit Assist if the surrounding is noisy.
- Safe Exit Assist does not operate in all situations or cannot prevent all collisions.
- Safe Exit Assist may warn the driver late or may not warn the driver depending on the road and driving conditions. Always check vehicle surroundings.
- The driver and passengers are responsible for accidents that occurs while exiting the vehicle. Always check the surroundings before you exit the vehicle.
- Never deliberately operate Safe Exit Assist. Doing so may lead to serious injury or death.

**\* NOTICE**

- After the vehicle is turned off, Safe Exit Assist operates approximately for 3 minutes, but turns off immediately if the doors are locked.
- The images and colors in the instrument cluster may differ depending on the cluster type or theme selected from the settings menu.

**Safe Exit Assist malfunction and limitations**

**Safe Exit Assist malfunction**

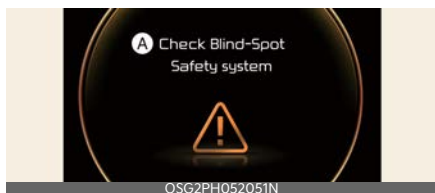



### A: Check Blind-Spot Safety system

When Safe Exit Assist is not working properly, the warning message will appear on the cluster for several seconds, and the master (⚠) warning light will appear on the cluster. Have Safe Exit Assist be inspected by an authorized Kia dealer.

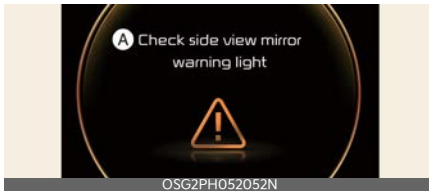

### A: Check side view mirror warning light

When the outside rearview mirror warning light is not working properly, the warning message will appear on the cluster for several seconds, and the master (⚠) warning light will appear on the cluster. Have Safe Exit Assist be inspected by an authorized Kia dealer.

### Safe Exit Assist disabled

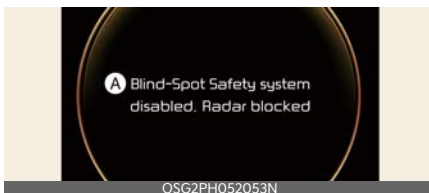

### A: Blind-Spot Safety system disabled. Radar blocked

When the rear bumper around the rear corner radar is covered with foreign material, such as snow or rain, or installing a trailer or carrier, it can reduce the detecting performance and temporarily limit or disable Safe Exit Assist.

If this occurs, the warning message will appear on the cluster.

Safe Exit Assist will operate properly when such foreign material or trailer, etc., is removed, and then the vehicle is restarted.

If Safe Exit Assist does not operate properly after it is removed, have the vehicle inspected by an authorized Kia dealer.

### ⚠ WARNING

- Even though the warning message does not appear on the cluster, Safe Exit Assist may not properly operate.
- Safe Exit Assist may not properly operate in an area (for example, open terrain) where any objects are not detected right after the vehicle is turned on, or when the detecting sensor is blocked with foreign material right after the vehicle is turned on.

### ⚠ CAUTION

Turn off Safe Exit Assist to install or remove a trailer, carrier, or another attachment. Turn on Safe Exit Assist when finished.

### Limitations of Safe Exit Assist

Safe Exit Assist may not operate properly, or it may operate unexpectedly under the following circumstances:

- Getting out of the vehicle where trees or grass are overgrown
- Getting out of the vehicle where the road is wet
- The approaching vehicle is very fast or very slow

### \* NOTICE

For more details on the limitations of the rear corner radar, refer to "Blind-Spot Collision-Avoidance Assist (BCA) (if equipped)" on page 6-85.

**⚠ WARNING**

- Safe Exit Assist may not operate properly if interfered by strong electromagnetic waves.
- Safe Exit Assist may not operate for 3 seconds after the vehicle is started, or the rear corner radars are initialized.

**Manual Speed Limit Assist (MSLA)**



- 1 Speed Limit indicator
- 2 Set speed

You can set the speed limit when you do not want to drive over a specific speed. If you drive over the preset speed limit, Manual Speed Limit Assist operates (set speed limit will blink and chime will sound) until the vehicle speed returns within the speed limit.

**Manual Speed Limit Assist operation**

**Setting speed limit**

1. Press and hold Driving Assist (Ⓜ) button at the desired speed. The Speed Limit (LIMIT) indicator will appear on the cluster.



2. Push the (+) switch up or (-) switch down, and release it at the desired speed.  
Push the (+) switch up or (-) switch down and hold it. The speed will increase or decrease to the nearest multiple of 5 in mph (multiple of 10) at first, and then increase or decrease by 10 km/h (5 mph).

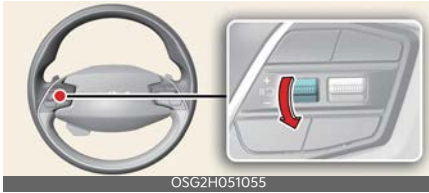
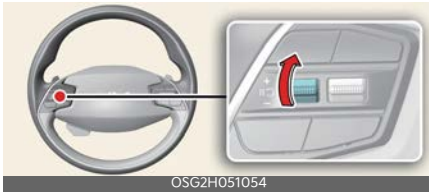

3. The set speed limit will be displayed on the cluster.

If you would like to drive over the pre-set speed limit, depress the accelerator pedal beyond the pressure point to activate the kickdown mechanism. The set speed limit will blink and chime will sound until you return the vehicle speed within the speed limit.



**\* NOTICE**

When the accelerator pedal is not depressed beyond the pressure point, vehicle speed will maintain within the speed limit.

**Temporarily pausing Manual Speed Limit Assist**



Press the (||) switch to temporarily pause the set speed limit. The set speed limit will turn off but the Speed Limit (LIMIT) indicator will stay on.

**Resuming Manual Speed Limit Assist**



To resume Manual Speed Limit Assist after the function was paused, operate the (+), (-), (||) switch.

If you push the (+) switch up or (-) switch down, vehicle speed will be set to the current speed on the cluster.

If you press the (||) switch, vehicle speed will resume to the preset speed.

**Turning off Manual Speed Limit Assist**



Press the Driving Assist (DA) button to turn Manual Speed Limit Assist off. The

Speed Limit (SPEED LIMIT) indicator will go off.

**⚠ WARNING**

Take the following precautions when using Manual Speed Limit Assist:

- Always set the vehicle speed under the speed limit in your country.
- Keep Manual Speed Limit Assist off when the function is not in use, to avoid inadvertently setting a speed. Check that the Speed Limit (SPEED LIMIT) indicator is off.
- Manual Speed Limit Assist does not substitute for proper and safe driving. It is the responsibility of the driver to always drive safely and should always be aware of unexpected and sudden situations from occurring. Pay attention to the road conditions at all times.

**Intelligent Speed Limit Assist (ISLA) (if equipped)**

Intelligent Speed Limit Assist uses information from the detected road sign and navigation system to inform the driver of the speed limit and additional information of the current road. Also, Intelligent Speed Limit Assist helps the driver to maintain within the speed limit of the road.

**⚠ CAUTION**

- Intelligent Speed Limit Assist may not operate properly if the function is used in other countries.
- If a navigation is applied to your vehicle, the navigation needs to be regularly updated for Intelligent Speed Limit Assist to operate properly. For more information, refer to the user's manual provided in the infotainment system and the quick reference guide.

**Detecting sensor**

Front view camera



Refer to the picture above for the detailed location of the detecting sensor.

**⚠ CAUTION**

For more details on the precautions of the front view camera, refer to "Forward Collision-Avoidance Assist (FCA) (Front Camera Only) (if equipped)" on page 6-58.

## Intelligent Speed Limit Assist settings

### Speed limit

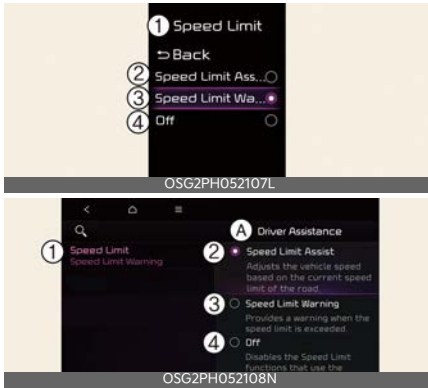

A: **Driver Assistance**

**1 Speed Limit**

**2 Speed Limit Assist**

**3 Speed Limit Warning**

**4 Off**

With the vehicle on, touch **Settings** → **Driver Assistance** → **Speed Limit** on the instrument cluster or **Settings** → **Vehicle** → **Driver Assistance** → **Speed Limit** on the infotainment system.

- **Select Country:** If the vehicle is not equipped with navigation system, a settings menu will be provided to select the country manually. For Intelligent Speed Limit Assist to operate properly, select the country where the vehicle is currently being driven.
- **Speed Limit Tolerance:** The tolerance for Speed limit can be adjusted. The vehicle will warn the speed limit or adjust the driving speed when the current driving speed is higher than the recognized speed limit added with set tolerance value.

- **Speed Limit Assist:** Intelligent Speed Limit Assist will inform the driver of speed limit and additional road signs. In addition, Intelligent Speed Limit Assist will inform the driver to change set speed of Manual Speed Limit Assist or Smart Cruise Control (If equipped) to help the driver stay within the speed limit.
- **Speed Limit Warning:** Intelligent Speed Limit Assist will inform the driver of speed limit and additional road signs. In addition, Intelligent Speed Limit Assist will warn the driver when the vehicle is driven faster than the speed limit. Manual Speed Limit Assist or Smart Cruise Control (If equipped) set speed will not be automatically adjusted. The driver should adjust the speed manually.
- **Off:** Intelligent Speed Limit Assist will turn off.

### \* INFORMATION

The infotainment system may change after software updates. For more information, refer to the user's manual provided in the infotainment system and the quick reference guide.

### Speed limit offset



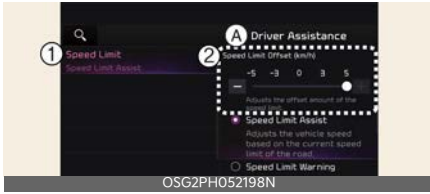

OSG2PH052198N

**A: Driver Assistance**

**1 Speed Limit**

**2 Speed Limit Offset (km/h)**

With the vehicle on, touch **Settings** → **Driver Assistance** → **Speed Limit** on the instrument cluster or **Settings** → **Vehicle** → **Driver Assistance** → **Speed Limit** on the infotainment system.

**Speed Limit Warning** and **Speed Limit Assist** warns the driver when driving speed exceeds the speed at which the set **Speed Limit Offset** is added to the speed limit, or applies the Speed limit offset setting to the detected speed limit.

**⚠ WARNING**

For your safety, change the settings after parking the vehicle at a safe location.

**\* NOTICE**

- Speed limit and Speed warning function operates based on an offset value added with the speed limit. Set the offset value to '0' to change or warn the speed according to the recognized speed limit.
- The setting of Speed limit offset is not reflected in Navigation-based Smart Cruise Control.

**\* INFORMATION**

The infotainment system may change after software updates. For more information, refer to the user's manual pro-

vided in the infotainment system and the quick reference guide.

**Warning Sound and Haptic**



OSG2PH052194N

**A: Driver Assistance**

**1 Warning Sound and Haptic**

**2 Warning Volume**

**3 Driving Safety Priority**

With the vehicle on, touch **Settings** → **Vehicle** → **Driver Assistance** → **Warning Style** on the infotainment system to change the Warning Style.

- **Warning Volume:** You can adjust the Warning Volume from level 1 to 3. If equipped with steering wheel vibration, the volume level can be set from 0 to 3.
- **Driving Safety Priority:** For safe driving, the audio volume will temporarily decrease to warn the driver with the audible warning.

**\* NOTICE**

- Ensure that Warning Style you have set may apply to the Warning volume of other Driver Assistance systems.
- Warning Style will maintain its last setting even if the vehicle is restarted.
- If not equipped with the navigation system, select **User Settings** → **Driver Assistance** to adjust the Warning Volume.
- The setting menu may not be available for your vehicle depending on

the vehicle features and specifications.

- Descriptions of each Driver Assistance system may be slightly different from the owner's manual after updating the software of your infotainment system. In this case, scan the QR code in the infotainment system manual to access the web manual for checking the changes.

## Intelligent Speed Limit Assist operation

### Warning and control

Intelligent Speed Limit Assist is warned and controlled by the following action.

- Displaying speed limit
- Warning overspeed
- Changing set speed

#### \* NOTICE

Intelligent Speed Limit Assist warning and control are described based on the Offset adjust to '0'. For details on Offset setting, refer to "Intelligent Speed Limit Assist settings" on page 6-105.

### Displaying speed limit



Speed limit information is displayed on the instrument cluster.

#### \* NOTICE

- If speed limit information of the road cannot be recognized, '---' sign will be

displayed. Please refer to "Intelligent Speed Limit Assist malfunction and limitations" on page 6-108 if the road signs are difficult to recognize.

- Intelligent Speed Limit Assist provides additional road sign information in addition to speed limit. The additional road sign information provided may vary according to your country.
- The images and colors in the instrument cluster may differ depending on the cluster type or theme selected from the settings menu.

### Warning overspeed



When driving at a speed higher than the displayed speed limit, the red speed limit indicator will be indicated.

### Changing set speed

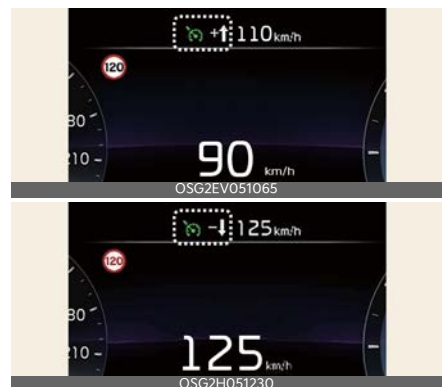

If the speed limit of the road changes during the operation of Manual Speed Limit Assist or Smart Cruise Control, an

arrow in the direction of up or down is displayed to inform the driver that the set speed needs to be changed. At this time, the driver can change the set speed according to the speed limit by using the (+) or (-) switch on the steering wheel.

**⚠ WARNING**

- When driving at a speed lower than the speed limit, set the offset under '0', or press (-) switch to decrease your set speed.
- Even after changing the set speed according to the speed limit of the road, the vehicle can still be driven over the speed limit. If necessary, depress the brake pedal to reduce your driving speed.
- If the speed limit of the road is under 30 km/h (20 mph), the set speed change function will not work.
- Intelligent Speed Limit Assist operates using the speed unit in the instrument cluster set by the driver. If the speed unit is set to a unit other than the speed unit used in your country, Intelligent Speed Limit Assist may not operate properly.

**\* NOTICE**

- For more details on Manual Speed Limit Assist operation, refer to "Manual Speed Limit Assist (MSLA)" on page 6-102.
- For more details on Smart Cruise Control operation, refer to "Smart Cruise Control (SCC) (if equipped)" on page 6-118.

**Intelligent Speed Limit Assist malfunction and limitations**

**Intelligent Speed Limit Assist malfunction**



**A: Check Speed Limit system**

When Intelligent Speed Limit Assist is not working properly, the warning message will appear on the cluster for several seconds, and the master (⚠) warning light and speed limit warning light (⊠) will appear on the cluster. If this occurs, have the vehicle inspected by an authorized Kia dealer.

**Intelligent Speed Limit Assist disabled**

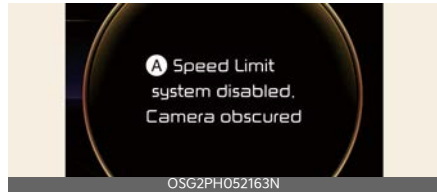

**A: Speed Limit system disabled. Camera obscured**

When the front windshield where the front view camera is located is covered with foreign material, such as snow or rain, it can reduce the detecting performance and temporarily limit or disable Intelligent Speed Limit Assist. If this occurs, the warning message and speed limit warning light (⊠) will appear on the cluster.

Intelligent Speed Limit Assist will operate properly when snow, rain or foreign



material is removed. Always keep it clean.

If Intelligent Speed Limit Assist does not operate properly after it is removed, have the vehicle inspected by an authorized Kia dealer.

### **WARNING**

Even though the warning message or warning light does not appear on the cluster, Intelligent Speed Limit Assist may not operate properly.

## Limitations of Intelligent Speed Limit Assist

Intelligent Speed Limit Assist may not operate properly, or it may operate unexpectedly under the following circumstances:

- The road sign is contaminated or indistinguishable
  - The road sign is difficult to see due to bad weather, such as rain, snow, fog, etc.
  - The road sign is partially obscured by surrounding objects or shadow
- The road signs do not conform to the standard
  - The text or picture on the road sign is different from the standard
  - The road sign is installed between the main line and the exit road or between diverging roads
  - A sign is attached to another vehicle
- The distance between the vehicle and the road signs is far
- The vehicle encounters appearing road signs
- Intelligent Speed Limit Assist incorrectly recognizes numbers or pictures in the street signs or other signs as the speed limit
- A road sign near the road you are driving is detected
- Multiple signs are installed close together
- Other Auxiliary signs or commercial signs are placed around the speed limit signs.
- The minimum speed limit sign is mis-recognized
- The minimum speed limit sign is on the road
- The brightness changes suddenly, for example when entering or exiting a tunnel or passing under a bridge
- Headlamps are not used or the brightness of the headlamps are weak at night or in the tunnel
- The field of view of the front view camera is obstructed by sun glare
- Road signs are difficult to recognize due to the reflection of sunlight, street lights, or oncoming vehicles
- The navigation information or GPS information contain errors.
- The driver does not follow the guide of the navigation.
- Driving on a road that is sharply curved or continuously curved
- Driving through speed bumps, or driving up and down or left to right on steep inclines
- The vehicle is shaking heavily
- Driving on a newly opened road
- The navigation is updated while driving
- The navigation is restarted while driving

**⚠ WARNING**

- Intelligent Speed Limit Assist is a supplemental function that helps the driver to comply with the speed limit on the road, and may not display the correct speed limit or control the driving speed properly.
- It is the responsibility of the driver to keep the speed limit.
- When initializing (rebooting) the camera or restarting the vehicle, the function may not operate for approximately 15 seconds.

**\* NOTICE**

For more details on the limitations of the front view camera, refer to "Forward Collision-Avoidance Assist (FCA) (Front Camera Only) (if equipped)" on page 6-58.

**Driver Attention Warning (DAW)****Basic function**

Driver Attention Warning can help determine the driver's attention level by analyzing driving pattern and driving time while the vehicle is driven. Driver Attention Warning will recommend a break when the driver's attention level falls below a certain level.

**Leading vehicle departure alert function**

Leading Vehicle Departure Alert function will inform the driver when a detected vehicle in front departs from a stop.

**Detecting sensor**

Front view camera



The front view camera is used as a detecting sensor to help detect driving patterns and front vehicle departure while vehicle is being driven.

Refer to the picture above for the detailed location of the detecting sensor.

**⚠ CAUTION**

- Always keep the front view camera in good condition to maintain optimal performance of Driver Attention Warning.

- For more details on the precautions of the front view camera, refer to "Forward Collision-Avoidance Assist (FCA) (Front Camera Only) (if equipped)" on page 6-58.

## Driver Attention Warning settings

### Driver Attention Warning



#### A: Driver Assistance

- Driver Attention Warning
- Inattentive Driving Warning

With the vehicle on, touch or deselect **Settings** → **Driver Assistance** → **Driver Attention Warning** on the instrument cluster or select **Settings** → **Vehicle** → **Driver Assistance** → **Driver Attention Warning** on the infotainment system.

- If **Inattentive Driving Warning** is selected, Driver Attention Warning will recommend taking a break when the level falls below a certain level.

#### \* INFORMATION

The infotainment system may change after software updates. For more information, refer to the user's manual provided in the infotainment system and the quick reference guide.

vided in the infotainment system and the quick reference guide.

### Leading Vehicle Departure Alert



#### A: Driver Assistance

- Driver Attention Warning
- Leading Vehicle Departure Alert

- If **Leading Vehicle Departure Alert** is selected, the function will inform the driver when a detected vehicle in front departs from a stop.

#### \* INFORMATION

The infotainment system may change after software updates. For more information, refer to the user's manual provided in the infotainment system and the quick reference guide.

### Driver Attention Warning operation

#### Basic function

The basic function of Driver Attention Warning is to warn the driver 'Consider taking a break'.

## Taking a break

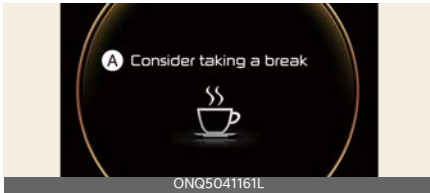

### A: Consider taking a break

Warning message will appear on the cluster and an audible warning will sound and driver attention warning light (⚠️) will appear to suggest that the driver take a break, when the driver's attention level is below a certain level.

- Driver Attention Warning will not suggest a break when the total driving time is shorter than 4 minutes has not passed after the last break was suggested.

Driver Attention Warning operates under the following conditions:

- Your driving speed: Approximately 0~200 km/h (0~120 mph).

### ⚠️ WARNING

For your safety, change the Settings after parking the vehicle at a safe location.

### ⚠️ CAUTION

- Driver Attention Warning may suggest a break depending on the driver's driving pattern or habits, even if the driver doesn't feel fatigued.
- Driver Attention Warning is a supplemental function and may not be able to determine whether the driver is inattentive.
- The driver who feels fatigued should take a break at a safe location, even

though there is no break suggestion by Driver Attention Warning.

### \* NOTICE

For more details on vehicle settings, refer to "User settings mode" on page 5-85.

## Leading vehicle departure alert function



### A: Leading vehicle is driving away

When a detected vehicle in front departs from a stop, Leading Vehicle Departure Alert will inform the driver by displaying the warning message on the cluster and an audible warning will sound.

### ⚠️ WARNING

- If any other function's warning message is displayed or audible warning is generated, Leading Vehicle Departure Alert's warning message may not be displayed and audible warning may not be generated.
- The driver should hold the responsibility to safely drive and control the vehicle.

### ⚠️ CAUTION

- Leading Vehicle Departure Alert is a supplemental function and may not alert the driver whenever the front vehicle departs from a stop.

- Always check the front of the vehicle and road conditions before departure.

### \* NOTICE

The images and colors in the instrument cluster may differ depending on the cluster type or theme selected from the settings menu.

## Driver Attention Warning malfunction and limitations

### Driver Attention Warning malfunction

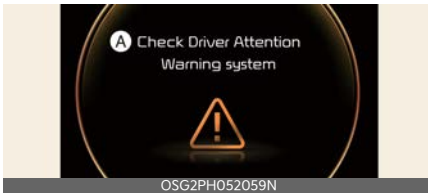

#### A: Check Driver Attention Warning system

When Driver Attention Warning is not working properly, the warning message will appear on the cluster for several seconds, and the master (⚠) warning light will appear on the cluster. If this occurs, have Driver Attention Warning be inspected by an authorized Kia dealer.

### Driver Attention Warning disabled

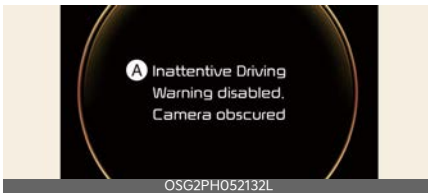

#### A: Inattentive Driving Warning disabled. Camera obscured

When the front view camera is located is covered with foreign material, such as snow or rain, it can reduce the detecting performance and temporarily limit or disable Driver Attention Warning.

If this occurs the warning message, and the (⚠) warning light will appear on the cluster. Driver Attention Warning will operate normally when snow, rain or foreign material is removed. Always keep it clean.

If Driver Attention Warning does not operate normally after obstruction (snow, rain, or foreign material) is removed, have the vehicle inspected by an authorized Kia dealer.

### ⚠ WARNING

- Driver Attention Warning may not work properly in areas where substances are not detected after turning ON the vehicle (e.g. in open terrain) or if the recognition sensor is contaminated.
- If restarting the vehicle with the sensors blocked or malfunctioned, the Driver Attention Warning may not properly operate as the function maintains the last setting.

## Limitations of Driver Attention Warning

Driver Attention Warning may not work properly in the following situations:

- The vehicle is driven violently
- The vehicle intentionally crosses over lanes frequently
- The vehicle is controlled by Driver Assistance system, such as Lane Keeping Assist

### Leading vehicle departure alert function

- When the vehicle cuts in

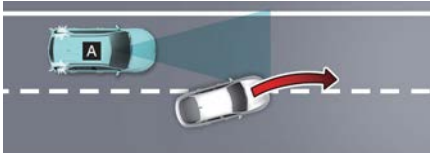

OSG2EV051098



OSG2H051048

[A]: Your vehicle, [B]: Front vehicle  
If a vehicle cuts in front of your vehicle, Leading Departure Alert may not operate properly.

- When the vehicle ahead sharply steers



OSG2EV051101

[A]: Your vehicle, [B]: Front vehicle  
If the vehicle in front makes a sharp turn, such as to turn left or right or make a U-turn, etc., Leading Vehicle Departure Alert may not operate properly.

- When the vehicle ahead abruptly departs

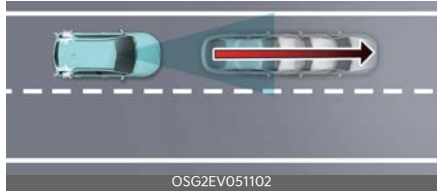

OSG2EV051102

If the vehicle in front abruptly departs, Leading Vehicle Departure Alert may not operate properly.

- When a pedestrian or bicycle is between you and the vehicle ahead



OSG2H051051

If there is a pedestrian(s) or bicycle(s) in between you and the vehicle in front, Leading Vehicle Departure Alert may not operate properly.

- When in a parking lot

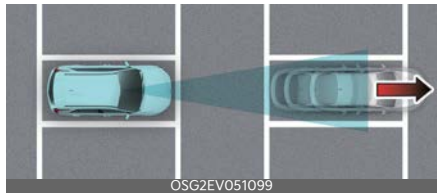

OSG2EV051099

If a vehicle parked in front drives away from you, Leading Vehicle Departure Alert may alert you that the parked vehicle is driving away.

- When driving at a tollgate or intersection, etc.

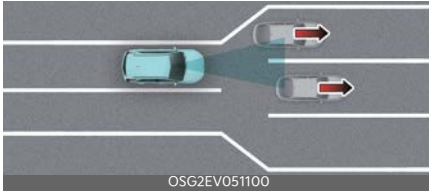

If you pass a tollgate or intersection with lots of vehicles or you drive where lanes are merged or divided frequently, Leading Vehicle Departure Alert may not operate properly.

**WARNING**

Driver Attention Warning may not operate for 15 seconds after the vehicle is started, or the front view camera is initialized.

**\* NOTICE**

For more details on the precautions of the front view camera, refer to "Forward Collision-Avoidance Assist (FCA) (Front Camera Only) (if equipped)" on page 6-58.

## Cruise Control (CC) (if equipped)



- 1 Cruise indicator
- 2 Set speed

Cruise Control will allow you to drive at speeds above 30 km/h (20 mph) without depressing the accelerator pedal.

### Cruise Control operation

#### Setting speed

1. Accelerate to the desired speed, which must be more than 30 km/h (20 mph).



2. Press the Driving Assist button at the desired speed. The set speed and Cruise (CRUISE) indicator will appear on the cluster.
3. Release the accelerator pedal. Vehicle speed will maintain the set speed even when the accelerator pedal is not depressed.

**\* NOTICE**

- The vehicle may slightly slow down or speed up while driving uphill or downhill.
- The Driving Assist button symbol may vary depending on your vehicle option.

**Increasing set speed**

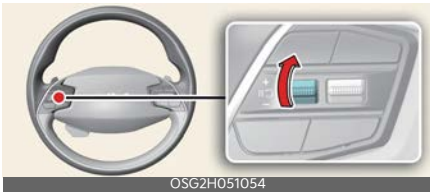

- Push the (+) switch up and release it immediately. The set speed will increase by 1 km/h (1 mph) each time the switch is operated in this manner.
- Push the (+) switch up and hold it while monitoring the set speed on the cluster. The set speed will increase to the nearest multiple of 5 in mph (multiple of 10) at first, and then increase by 10 km/h (5 mph) each time the switch is operated in this manner. Release the switch when the desired speed is shown and the vehicle will accelerate to that speed.

**Decreasing set speed**



- Push the (-) switch down and release it immediately. The set speed will decrease by 1 km/h (1 mph) each time the switch is operated in this manner.

- Push the (-) switch down and hold it while monitoring the set speed on the cluster. The set speed will decrease to the nearest multiple of 5 in mph (multiple of 10) at first, and then decrease by 10 km/h (5 mph) each time the switch is operated in this manner. Release the switch at the speed you want to maintain.

**Accelerating temporarily**

If you want to speed up temporarily when Cruise Control is on, depress the accelerator pedal.

To return to the set speed, take your foot off the accelerator pedal.

If you push the (+) switch up or (-) switch down at increased speed, the set speed will be set to the current increased speed.

**Temporarily pausing Cruise Control**



Cruise Control will be paused when:

- Depressing the brake pedal.
- Pressing the (||) switch.
- Shifting the gear to N (Neutral).
- Decreasing vehicle speed to less than approximately 30 km/h (20 mph).
- ESC (Electronic Stability Control) is operating.
- Downshifting to 2nd gear when in Manual Shift mode.

The set speed will turn off but the Cruise (CC) indicator will stay on.



**\* NOTICE**

If Cruise Control pauses during a situation that is not mentioned, have the vehicle inspected by an authorized Kia dealer.

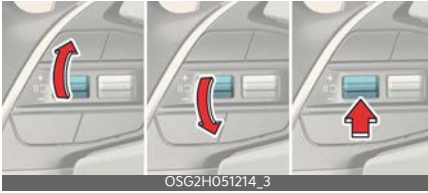
**Resuming Cruise Control**

Operate the (+), (-) or (↷) switch.

If you push the (+) switch up or (-) switch down, the set speed will be set to the current speed on the cluster.

If you press the (↷) switch, vehicle speed will resume to the preset speed.

The vehicle speed must be above 30 km/h (20 mph) for Cruise Control to resume.

**⚠ WARNING**

Check the driving condition before using the (↷) switch. Driving speed may sharply increase or decrease when you press the (↷) switch.

**Turning off Cruise Control**

Press the Driving Assist button to turn Cruise Control off. The Cruise (Ⓢ CRUISE) indicator will go off.

Always press the Driving Assist button to turn Cruise Control off when not in use.

**\* NOTICE**

If your vehicle is equipped with Manual Speed Limit Assist, press and hold the Driving Assist button to turn off Cruise Control. However, Manual Speed Limit Assist will turn on.

**⚠ WARNING**

Take the following precautions when using Cruise Control:

- Always set the vehicle speed under the speed limit in your country.
- Keep Cruise Control off when the function is not in use, to avoid inadvertently setting a speed. Check that the Cruise (Ⓢ CRUISE) indicator is off.
- Cruise Control does not substitute for proper and safe driving. It is the responsibility of the driver to always drive safely and should always be aware of unexpected and sudden situations from occurring.
- Always drive cautiously to prevent unexpected and sudden situations from occurring. Pay attention to the road conditions at all times.
- Do not use Cruise Control when it may be unsafe to keep the vehicle at a constant speed:
  - When driving in heavy traffic, or when traffic conditions make it difficult to drive at a constant speed
  - When driving on rainy, icy, or snow-covered roads
  - When driving on hilly or windy roads
  - When driving in windy areas

- When driving with limited view (possibly due to bad weather, such as fog, snow, rain and sandstorm)
  - Do not use Cruise Control when towing a trailer.
- 

## Smart Cruise Control (SCC) (if equipped)

### Basic function

Smart Cruise Control is designed to help detect the vehicle ahead and help maintain the desired speed and minimum distance between the vehicle ahead.

### Overtake acceleration assist function

If the driver attempts to overtake, the vehicle will accelerate to assist overtaking.

### Detecting sensor

Front view camera



Front radar



The front view camera and front radar are used as a detecting sensor to detect front vehicles.

Refer to the picture above for the detailed location of the detecting sensor.

### **CAUTION**

Always keep the front view camera and front radar in good condition to maintain

optimal performance of Smart Cruise Control.

For more details on the precautions of the front view camera and front radar, refer to "Forward Collision-Avoidance Assist (FCA) (Front Camera Only) (if equipped)" on page 6-58.

## Smart Cruise Control settings



With the vehicle on, touch **Settings** → **Driver Assistance** → **Driving Convenience** → **Smart Cruise Control** on the instrument cluster or **Settings** → **Vehicle** → **Driver Assistance** → **Driving Convenience** → **Smart Cruise Control** on the infotainment system to set the distance, acceleration and the reaction speed.

### \* INFORMATION

The infotainment system may change after software updates. For more information, refer to the user's manual provided in the infotainment system and the quick reference guide.

## Warning Sound and Haptic

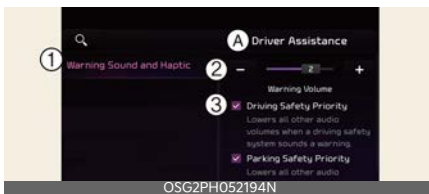

### A: Driver Assistance

### 1 Warning Sound and Haptic

### 2 Warning Volume

### 3 Driving Safety Priority

With the vehicle on, touch **Settings** → **Vehicle** → **Driver Assistance** → **Warning Style** on the infotainment system to change the Warning Style.

- **Warning Volume:** You can adjust the Warning Volume from level 1 to 3. If equipped with steering wheel vibration, the volume level can be set from 0 to 3.
- **Driving Safety Priority:** For safe driving, the audio volume will temporarily decrease to warn the driver with the audible warning.

### \* NOTICE

- Ensure that Warning Style you have set may apply to the Warning volume of other Driver Assistance systems.
- Warning Style will maintain its last setting even if the vehicle is restarted.
- If not equipped with the navigation system, select **User Settings** → **Driver Assistance** to adjust the Warning Volume.
- The setting menu may not be available for your vehicle depending on the vehicle features and specifications.
- Descriptions of each Driver Assistance system may be slightly different from the owner's manual after updating the software of your infotainment system. In this case, scan the QR code in the infotainment system manual to access the web manual for checking the changes.

## Smart Cruise Control operation

### Operating conditions for basic function

#### Basic function

Smart Cruise Control operates when the following conditions are satisfied.

- The gear is in D (Drive)
- Your vehicle speed is within the operating speed range
  - 10~160 km/h (5~100 mph): when there is no vehicle in front
  - 0~160 km/h (0~100 mph): when there is a vehicle in front
- ESC (Electronic Stability Control) or ABS is on
- Smart Cruise Control does not operate in the following conditions.
  - The driver's door is opened
  - Engine RPM is high
  - EPB (Electronic Parking Brake) is applied
  - ESC (Electronic Stability Control) or ABS is controlling the vehicle
  - Forward Collision-Avoidance Assist brake control is operating
  - Remote Smart Parking Assist brake control is operating (if equipped)

#### \* NOTICE

When stopped behind another vehicle, the driver can turn on Smart Cruise Control while the brake pedal is depressed.

### Operating conditions for Acceleration Assist

Overtaking Acceleration Assist will operate when the turn signal indicator is turned on to the left (left-hand drive) or turned on to the right (right-hand drive)

while Smart Cruise Control is operating, and the following conditions are satisfied:

- Your driving speed is above 60 km/h (40 mph)
- A vehicle is detected in front of your vehicle

Overtaking Acceleration Assist does not operate in the following conditions.

- The hazard warning flasher is on
- Vehicle speed is reduced to maintain distance with the vehicle in front

#### ⚠ WARNING

When the turn signal indicator is turned on to the left (left-hand drive) or turned on to the right (right-hand drive) while there is a vehicle ahead, the vehicle may accelerate temporarily. Pay attention to the road conditions at all times.

Regardless of your country's driving direction, Overtaking Acceleration Assist will operate when the conditions are satisfied. When using the function in countries with different driving direction, always check the road conditions at all times.

### Turning on Smart Cruise Control



OSG2H051043

Press the Driving Assist button to turn on Smart Cruise Control. The speed will be set to the current speed on the cluster.

- If there is no vehicle in front of you, the set speed will be maintained.

- If there is a vehicle in front of you, the speed may be adjusted to maintain the distance to the vehicle ahead. If the vehicle ahead accelerates, your vehicle will travel at a steady cruising speed after accelerating to the set speed.

**\* NOTICE**

- If your vehicle speed is between 0~30 km/h (0~20 mph) when you press the Driving Assist button, the Smart Cruise Control speed will be set to 30 km/h (20 mph).
- If the driver changes to the lower gear, the driving speed may not reach the set speed.

**Setting vehicle distance**



Each time the button is pressed, the headway changes as follows:

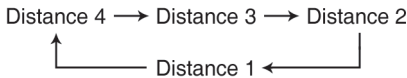

- If you drive at 90 km/h (56 mph), the distance is maintained as follows:  
 Distance 4 - approximately 52.5 m (172 ft.)  
 Distance 3 - approximately 40 m (130 ft.)  
 Distance 2 - approximately 32.5 m (106 ft.)  
 Distance 1 - approximately 25 m (82 ft.)

**\* NOTICE**

The distance is set to the last set distance when the vehicle is restarted, or when Smart Cruise Control was temporarily canceled.

**Increasing set speed**



- Push the (+) switch up and release it immediately. The set speed will increase by 1 km/h (1 mph) each time the switch is operated in this manner.
- Push the (+) switch up and hold it. The set speed will increase by 10 km/h (5 mph) each time the switch is operated in this manner.  
 You can increase the set speed to 160 km/h (100 mph).

**⚠ WARNING**

Check the driving condition before using the (+) switch. Driving speed may sharply increase when you push up and hold the (+) switch.

**Decreasing set speed**



- Push the (-) switch down and release it immediately. The set speed will

decrease by 1 km/h (1 mph) each time the switch is operated in this manner.

- Push the (-) switch down and hold it. The set speed will decrease by 10 km/h (5 mph) each time the switch is operated in this manner.

You can decrease the set speed to 30 km/h (20 mph).

### Temporarily canceling Smart Cruise Control



OSG2H051056\_2

Press the (||) switch or depress the brake pedal to temporarily cancel Smart Cruise Control.

### Resuming Smart Cruise Control



OSG2H051214\_3

To resume Smart Cruise Control after the function was canceled, operate the (+), (-) or (||) switch.

If you push the (+) switch up or (-) switch down, the set speed will be set to the current speed on the cluster.

If you press the (||) switch, vehicle speed will resume to the preset speed.

### **WARNING**

Check the driving condition before using the (||) switch. Driving speed may

sharply increase or decrease when you press the (||) switch.

### Turning off Smart Cruise Control



OSG2H051043

Press the Driving Assist button to turn Smart Cruise Control off.

### **\* NOTICE**

If your vehicle is equipped with Manual Speed Limit Assist, press and hold the Driving Assist button to turn off Smart Cruise Control. However Manual Speed Limit Assist will turn on.

### **WARNING**

Do not use the switches and buttons at the same time. Smart Cruise Control may not operate properly.

### Displaying operating status

You can see the status of the Smart Cruise Control operation in the Driving Assist view on the cluster. Refer to "LCD display modes" on page 5-83.

Smart Cruise Control will be displayed as below depending on the status of the function.

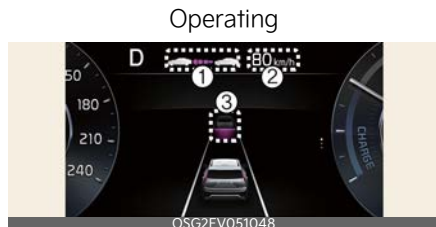

OSG2EV051048

## Temporarily canceled

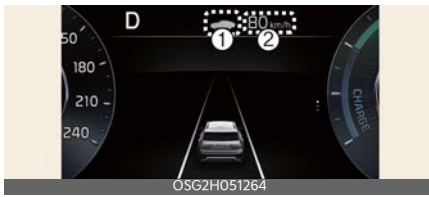

Smart Cruise Control will be displayed as below depending on the status of the function.

- When operating
  1. Whether there is a vehicle ahead and the selected distance level
  2. Set speed
  3. Whether there is a vehicle ahead and the target vehicle distance
- When temporarily canceled
  1. Vehicle (shaded)
  2. Previous set speed (shaded)

### \* NOTICE

- The distance of the front vehicle on the cluster is displayed according to the actual distance between your vehicle and the vehicle ahead.
- The target distance may vary according to your driving speed and the set distance level. If your driving speed is low, even though the vehicle distance have changed, the change of the target vehicle distance may be small.
- The images and colors in the instrument cluster may differ depending on the cluster type or theme selected from the settings menu.

## Accelerating temporarily

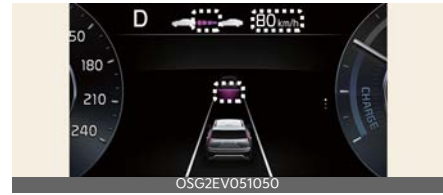

If you want to speed up temporarily without altering the set speed while Smart Cruise Control is operating, depress the accelerator pedal. While the accelerator pedal is depressed, the set speed, distance level and target distance will blink on the cluster.

However, if the accelerator pedal is depressed insufficiently, the vehicle may decelerate.

### ⚠ WARNING

Be careful when accelerating temporarily, because the speed and distance is not controlled automatically even if there is a vehicle in front of you.

## Temporarily canceling Smart Cruise Control

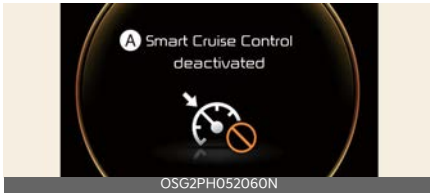

### A: Smart Cruise Control deactivated

Smart Cruise Control will be temporarily canceled automatically when:

- The vehicle speed is above 170 km/h (105 mph)
- The vehicle is stopped for a certain period of time
- The accelerator pedal is continuously depressed for a certain period of time
- The conditions for the Smart Cruise Control to operate is not satisfied

If Smart Cruise Control is temporarily canceled automatically, the warning message will appear on the cluster, and an audible warning will sound to warn the driver.

### \* NOTICE

If Smart Cruise Control is temporarily canceled while the vehicle is at a standstill with the function activated, EPB (Electronic Parking Brake) maybe applied.

### ⚠ WARNING

When Smart Cruise Control is temporarily canceled, distance with the front vehicle will not be maintained. Always have your eyes on the road while driving, and if necessary, depress the brake pedal to reduce your driving speed in order to maintain a safe distance.

## Smart Cruise Control conditions not satisfied

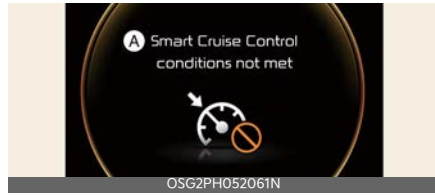

### A: Smart Cruise Control conditions not met

If the Driving Assist button, (+) switch, (-) switch or (⏏) switch is operated when Smart Cruise Control operating conditions are not satisfied, the warning message will appear on the cluster, and an audible warning will sound.

## In traffic situation

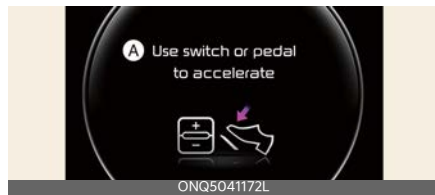

### A: Use switch or pedal to accelerate

In traffic, your vehicle will stop if the vehicle ahead of you stops. Also, if the vehicle ahead of you starts moving, your vehicle will start as well. In addition, after the vehicle has stopped and a certain time have passed, the warning message will appear on the cluster. Depress the accelerator pedal or operate the (+) switch, (-) switch or (⏏) switch to start driving.



## Warning road conditions ahead



### A: Watch for surrounding vehicles

In the following situation, the warning message will appear on the cluster, and an audible warning will sound to warn the driver of road conditions ahead.

### ⚠ WARNING

Always pay attention to vehicles or objects that may suddenly appear in front of you, and if necessary, depress the brake pedal to reduce your driving speed in order to maintain a safe distance.

## Collision warning



### A: Collision Warning

While Smart Cruise Control is operating, when the collision risk with the vehicle ahead is high, the warning message will appear on the cluster, and an audible warning will sound to warn the driver. Always have your eyes on the road while driving, and if necessary, depress the brake pedal to reduce your driving speed in order to maintain a safe distance.

### ⚠ WARNING

In the following situations, Smart Cruise Control may not warn the driver of a collision.

Always pay attention to road and driving conditions while driving.

- The distance from the front vehicle is near, or the vehicle speed of the front vehicle is faster or similar with your vehicle
- The speed of the front vehicle is very slow or is at a standstill
- The accelerator pedal is depressed right after Smart Cruise Control is turned on

### ⚠ WARNING

- Smart Cruise Control does not substitute for proper and safe driving. It is the responsibility of the driver to always check the speed and distance to the vehicle ahead.
- Smart Cruise Control may not recognize unexpected and sudden situations or complex driving situations, so always pay attention to driving conditions and control your vehicle speed.
- Keep Smart Cruise Control off when the function is not in use to avoid inadvertently setting a speed.
- Do not open the door or leave the vehicle when Smart Cruise Control is operating, even if the vehicle is stopped.
- Always be aware of the selected speed and headway distance.
- Keep a safe distance according to road conditions and vehicle speed. If the headway distance is too close during high-speed driving, a serious collision may result.

- When maintaining distance with the vehicle ahead, if the front vehicle disappears, Smart Cruise Control may suddenly accelerate to the set speed. Always be aware of unexpected and sudden situations from occurring.
- Vehicle speed may decrease on an upward slope and increase on a downward slope.
- Always be aware of situations such as when a vehicle cuts in suddenly.
- When you are towing a trailer or another vehicle, turn off Smart Cruise Control for safety reasons.
- Turn off Smart Cruise Control when your vehicle is being towed.
- Smart Cruise Control may not operate properly if interfered by strong electromagnetic waves.
- Smart Cruise Control may not detect an obstacle in front and lead to a collision. Always look ahead cautiously to prevent unexpected and sudden situations from occurring.
- Vehicles moving in front of you with a frequent lane change may cause a delay in Smart Cruise Control reaction or may cause Smart Cruise Control to react to a vehicle actually in an adjacent lane. Always drive cautiously to prevent unexpected and sudden situations from occurring.
- Always be aware of the surroundings and drive safely, even though a warning message does not appear or an audible warning does not sound.
- If any other function's warning message is displayed or warning sound is generated, Smart Cruise Control warning message may not be displayed and warning sound may not be generated.

- You may not hear the warning sound of Forward Collision-Avoidance Assist if the surrounding is noisy.
- The vehicle manufacturer is not responsible for any traffic violation or accidents caused by the driver.
- Always set the vehicle speed under the speed limit in your country.

**\* NOTICE**

- Smart Cruise Control may not operate for a few seconds after the vehicle is restarted or the front view camera or front radar is initialized.
- You may hear a sound when the brake is controlled by Smart Cruise Control.

**Smart Cruise Control malfunction and limitations**

**Smart Cruise Control malfunction**

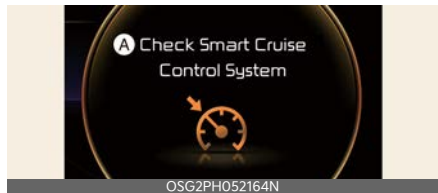

**A: Check Smart Cruise Control System**

When Smart Cruise Control is not working properly, the warning message will appear, and the (⚠) warning light will appear on the cluster. Have Smart Cruise Control be inspected by an authorized Kia dealer.

## Smart Cruise Control disabled

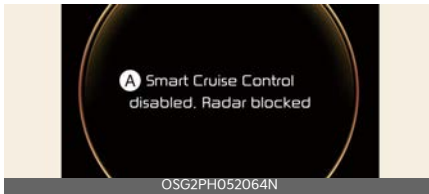

### A: Smart Cruise Control disabled. Radar blocked

When the front radar cover or sensor is covered with snow, rain, or foreign material, it can reduce the detecting performance and temporarily limit or disable Smart Cruise Control.

If this occurs the warning message will appear for a certain period of time on the cluster.

Smart Cruise Control will operate properly when snow, rain or foreign material is removed.

Always keep it clean.

#### **WARNING**

Even though the warning message does not appear on the cluster, Smart Cruise Control may not properly operate.

#### **CAUTION**

Smart Cruise Control may not properly operate in an area (e.g. open terrain), where there is nothing to detect, or detecting sensor is covered in foreign material after turning ON the vehicle.

### Limitations of Smart Cruise Control

Smart Cruise Control may not operate properly, or it may operate unexpectedly under the following circumstances:

- The detecting sensor or the surroundings are contaminated or damaged

- Washer fluid is continuously sprayed, or the wiper is on
- The camera lens is contaminated due to tinted, filmed or coated windshield, damaged glass, or sticky foreign material (sticker, bug, etc.) on the glass
- Moisture is not removed or frozen on the windshield
- The field of view of the front view camera is obstructed by sun glare
- Street light or light from an oncoming vehicle is reflected on the wet road surface, such as a puddle on the road
- The temperature around the front view camera is high or low
- An object is placed on the dashboard
- The surrounding is very bright
- The surrounding is very dark, such as in a tunnel, etc.
- The brightness changes suddenly, for example when entering or exiting a tunnel
- The brightness outside is low, and the headlamps are not on or are not bright
- Driving in heavy rain or snow, or thick fog
- Driving through steam, smoke or shadow
- Only part of the vehicle is detected
- The vehicle in front has no tail lights, tail lights are located unusually, etc.
- The brightness outside is low, and the tail lamps are not on or are not bright
- The rear of the front vehicle is small or does not look normal (for example, tilted, overturned, etc.)
- The front vehicle's ground clearance is low or high
- A vehicle suddenly cuts in front

- Your vehicle is being towed
- An object reflecting off the front radar such as a guardrail, nearby vehicle, etc.
- The bumper around the front radar is impacted, damaged or the front radar is out of position
- The temperature around the front radar is high or low
- The vehicle in front is made of material that does not reflect on the front radar
- Driving near a highway (or motorway) interchange or tollgate
- Driving on a slippery surface due to snow, water puddle, ice, etc.
- Driving on a curved road
- The vehicle in front is detected late
- The vehicle in front is suddenly blocked by an obstacle
- The vehicle in front suddenly changes lane or suddenly reduces speed
- The vehicle in front is bent out of shape
- The front vehicle's speed is fast or slow
- With a vehicle in front, your vehicle changes lane suddenly at low speed
- The vehicle in front is covered with snow
- Unstable driving
- You are on a roundabout and the vehicle in front is not detected
- You are continuously driving in a circle
- The adverse road conditions cause excessive vehicle vibrations while driving
- Your vehicle height is low or high due to heavy loads, abnormal tire pressure, etc.

- Driving in following places
  - Driving in a parking lot
  - Driving through a construction area, unpaved road, partial paved road, uneven road, speed bumps, etc.
  - Driving on an incline road, curved road, etc.
  - Driving through a roadside with trees or streetlights
  - Driving through a narrow road where trees or grass are overgrown
  - There is interference by electromagnetic waves, such as driving in an area with strong radio waves or electrical noise
  - Driving on a curved road
- Driving through a tunnel or iron bridge
- Driving near areas containing metal substances, such as a construction zone, railroad, etc.
- Driving in vast areas where there are few vehicles or structures (for example, desert, meadow, suburb, etc.)
  - Driving through steam, smoke or shadow
  - Driving near a highway (or motorway) interchange or tollgate
  - Driving near areas containing metal substances, such as a construction zone, railroad, etc.



On curves, Smart Cruise Control may not detect a vehicle in the same lane, and may accelerate to the set speed.

Also, vehicle speed may rapidly decrease when the vehicle ahead is detected suddenly.

Select the appropriate set speed on curves and apply the brake pedal or accelerator pedal according to the road and driving conditions ahead.



Your vehicle speed can be reduced due to a vehicle in the adjacent lane. Check to be sure that the road conditions permit safe operation of Smart Cruise Control and if necessary, depress the brake pedal to reduce your driving speed in order to maintain a safe distance

- Driving on an inclined road



During uphill or downhill driving, the Smart Cruise Control may not detect a moving vehicle in your lane, and cause your vehicle to accelerate to the set speed. Also, vehicle speed will rapidly decrease when the vehicle ahead is detected suddenly.

Select the appropriate set speed on inclines and apply the brake pedal or accelerator pedal according to the road and driving conditions ahead.

- Changing lanes



[A]: Your vehicle,

[B]: Lane changing vehicle

When a vehicle (B) moves into your lane from an adjacent lane, it cannot be detected by the sensor until it is in the sensor's detection range. Smart Cruise Control may not immediately detect the vehicle when the vehicle changes lanes abruptly. In this case, you must maintain a safe braking distance, and if necessary, depress the brake pedal to reduce your driving speed in order to maintain a safe distance.

- Situations when detecting are limited



In the following cases, some vehicles in your lane cannot be detected by the sensor:

- Vehicles offset to one side
- Slow-moving vehicles or sudden-decelerating vehicles

- Vehicles with higher ground clearance or vehicles carrying loads that stick out of the back of the vehicle
- Vehicles that has the front lifted due to heavy loads
- Vehicles within approximately 2 m (6 ft.) from your vehicle
- Oncoming vehicles
- Stopped vehicles
- Vehicles with small rear profile, such as trailers
- Narrow vehicles, such as motorcycles, bicycles, or powered two-wheelers
- Special vehicles
- Animals and pedestrians



In the following cases, the vehicle in front cannot be detected by the sensor. Always pay attention to the road and driving conditions and drive safely. If necessary, adjust your vehicle speed.

- You are steering your vehicle
- Driving on narrow or sharply curved roads



- When a vehicle ahead disappears at an intersection, your vehicle may accelerate. Always pay attention to road and driving conditions while driving.

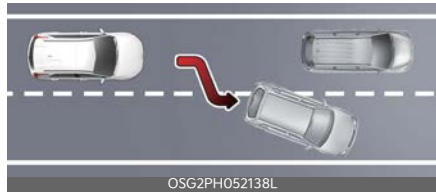

- When a vehicle in front of you merges out of the lane, Smart Cruise Control may not immediately detect the new vehicle that is now in front of you. Always pay attention to road and driving conditions while driving.



- Always look out for pedestrians when your vehicle is maintaining a distance with the vehicle ahead.

**This device complies with Industry Canada licence-exempt RSS standard(s).**

Operation is subject to the following conditions:

1. This device may not cause interference, and

2. This device must accept any interference, including interference that may cause undesired operation of the device.
3. Changes or modifications not expressly approved by the party responsible for compliance could void the user's authority to operate the device.

## Navigation-based Smart Cruise Control (NSCC) (if equipped)

Navigation-based Smart Cruise Control can help drive at a certain speed according to the road conditions when driving on highways (or motorways) by using road information from the navigation system while Smart Cruise Control is operating.

### \* NOTICE

- Navigation-based Smart Cruise Control is available only on controlled access road of certain highways.
  - \* Controlled access road indicates roads with limited entrances and exits that allow uninterrupted high speed traffic flow. Only passenger cars and motorcycles are allowed on controlled access roads.

Available highway (Controlled access road)	
USA	Select Interstate Highway and U.S. (Federal) and State Highways
Canada	Select Provincial and Territorial Highways

- Additional highways may be expanded by future navigation updates.

### \* NOTICE

Navigation-based Smart Cruise Control operates on main roads of highways (or motorways), and does not operate on interchanges or junctions.

### ⚠ WARNING

Navigation-based Smart Cruise Control (NSCC) is a supplemental function and is not a substitute for safe driving. It is the responsibility of the driver to always check the speed and distance to the

vehicle ahead. Always drive safely and use caution.

## Highway Curve Zone Auto Slow-down

If vehicle speed is high, Highway Curve Zone Auto Slowdown function will temporarily decelerate your vehicle or limit acceleration to help you drive safely on a curve based on the curve information from the navigation.

## Navigation-based Smart Cruise Control settings

### Highway Auto Speed Change

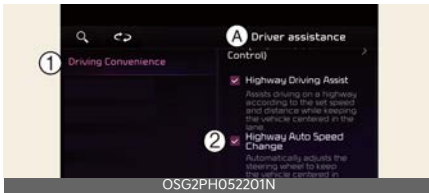

#### A: Driver Assistance

#### 1 Driving Convenience

#### 2 Highway Auto Speed Change

With the vehicle on, touch **Settings** → **Vehicle** → **Driver Assistance** → **Driving convenience** → **Highway Auto Speed Change** on the infotainment system.

#### \* NOTICE

When there is a problem with Navigation-based Smart Cruise Control, the function cannot be set from the Settings menu.

#### \* INFORMATION

The infotainment system may change after software updates. For more information, refer to the user's manual pro-

vided in the infotainment system and the quick reference guide.

## Navigation-based Smart Cruise Control operation

### Operating conditions

Navigation-based Smart Cruise Control is ready to operate if all of the following conditions are satisfied:

- Smart Cruise Control is operating
- Driving on main roads of highways (or motorways)

#### \* NOTICE

For more details on how to operate Smart Cruise Control, refer to "Smart Cruise Control (SCC) (if equipped)" on page 6-118.

## Navigation-based Smart Cruise Control display and control

When Navigation-based Smart Cruise Control operates, it will be displayed on the cluster as follows:

### Navigation-based Smart Cruise Control standby



If the operating conditions are satisfied, the white (NAV) symbol will appear.



## Navigation-based Smart Cruise Control operating



If temporary deceleration is required in the standby state and Navigation-based Smart Cruise Control is operating, the green (NAV) symbol will appear on the cluster.

If the Highway Set Speed Auto Change function operates, the (NAV) symbol and set speed will appear in green on the cluster, and an audible warning will sound.

### ⚠ WARNING



#### A: Drive carefully

The warning message will appear in the following circumstances:

- Navigation-based Smart Cruise Control is not able to slow down your vehicle to a safe speed

### \* NOTICE

- Highway Curve Zone Auto Slowdown and Highway Set Speed Auto Change function uses the same (NAV) symbol.
- The images and colors in the instrument cluster may differ depending on

the cluster type or theme selected from the settings menu.

## Highway Curve Zone Auto Slowdown

- Depending on the curve ahead on the highway (or motorway), the vehicle will decelerate, and after passing the curve, the vehicle will accelerate to Smart Cruise Control set speed.
- Vehicle deceleration time may differ depending on the vehicle speed and the degree of the curve on the road. The higher the driving speed, deceleration will start faster.

## Highway Set Speed Auto Change

- Highway Set Speed Auto Change function will operate when Smart Cruise Control set speed and the highway (or motorway) speed limit is matched.
- While Highway Set Speed Auto Change function is operating, when the highway (or motorway), speed limit changes, Smart Cruise Control set speed automatically changes to the changed speed limit.
- If Highway Set Speed Auto Change function has changed to the standby state by driving on a road other than the highway (or motorway) main road, Highway Set Speed Auto Change function will operate again when you drive on the main road again without setting the set speed.
- If Highway Set Speed Auto Change function has changed to the standby state by depressing the brake pedal or pressing the (|||) switch on the steering wheel, press the (|||) switch to restart the function.

### Limitations of Navigation-based Smart Cruise Control

Navigation-based Smart Cruise Control may not operate properly under the following circumstances:

- The navigation is not working properly
- Speed limit and road information in the navigation is not updated
- Map information is not transmitted due to infotainment system's abnormal operation
- The map information and the actual road is different because of real-time GPS data or map information error
- The navigation searches for a route while driving
- GPS signals are blocked in areas such as a tunnel
- A road that divides into two or more roads and joins again
- The driver goes off course the route set in the navigation
- The route to the destination is changed or canceled by resetting the navigation
- The vehicle enters a service station or rest area
- Android Auto or Car Play is operating
- The navigation cannot detect the current vehicle position (for example, elevated roads including overpass adjacent to general roads or nearby roads exist in a parallel way)
- The navigation is being updated while driving
- The navigation is being restarted while driving
- The speed limit of some sections changes according to the road situations

- Driving on a road under construction
- Driving on a road that is controlled
- There is bad weather, such as heavy rain, heavy snow, etc.
- Driving on a road that is sharply curved

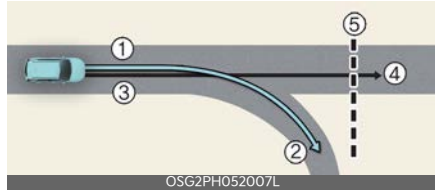

[1]: Set route, [2]: Branch line, [3]: Driving route, [4]: Main road, [5]: Curved road section

- When there is a difference between the navigation set route (branch line) and the driving route (main road), Highway Curve Zone Auto Slowdown function may not operate until the driving route is recognized as the main road.
- When the vehicle's driving route is recognized as the main road by maintaining the main road instead of the navigation set route, Highway Curve Zone Auto Slowdown function will operate. Depending on the distance to the curve and the current vehicle speed, vehicle deceleration may not be sufficient or may decelerate rapidly.

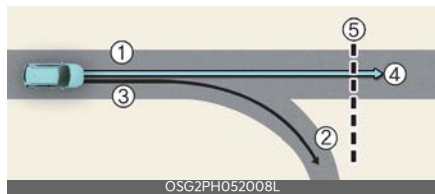

[1]: Main road, [2]: Branch line, [3]: Driving route, [4]: Set route, [5]: Curved road section

- When there is a difference between the navigation route (main road) and the driving route (branch line), Highway Curve Zone Auto Slowdown function will operate based on the curve information on the main road.
- When it is judged that you are driving out of the route by entering the highway interchange or junction, Highway Curve Zone Auto Slowdown function will not operate.

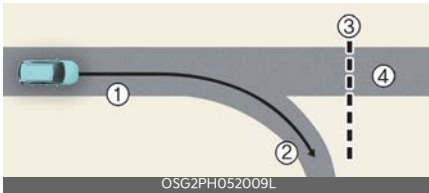

[1]: Driving route, [2]: Branch line, [3]: Curved road section, [4]: Main road

- If there is no destination set on the navigation, Highway Curve Zone Auto Slowdown function will operate based on the curve information on the main road.
- Even if you depart from the main road, Highway Curve Zone Auto Slowdown function may temporarily operate due to navigation information of the highway curve section.

**WARNING**

- Navigation-based Smart Cruise Control is not a substitute for safe driving practices, but a convenience function. Always have your eyes on the road, and it is the responsibility of the driver to avoid violating traffic laws.
- The navigation's speed limit information may differ from the actual speed limit information on the road. It is the driver's responsibility to check the speed limit on the actual driving road or lane.

- Navigation-based Smart Cruise Control will automatically be canceled when you leave the highway (or motorway) main road. Always pay attention to road and driving conditions while driving.
- Navigation-based Smart Cruise Control may not operate due to the existence of leading vehicles and the driving conditions of the vehicle. Always pay attention to road and driving conditions while driving.
- When you are towing a trailer or another vehicle, turn off Navigation-based Smart Cruise Control for safety reasons.
- After you pass through a tollgate on a highway (or motorway), Navigation-based Smart Cruise Control will operate based on the first lane. If you enter one of the other lanes, Navigation-based Smart Cruise Control might not operate properly.
- The vehicle will accelerate if the driver depresses the accelerator pedal while Navigation-based Smart Cruise Control is operating, and the function will not decelerate the vehicle. However, if the accelerator pedal is depressed insufficiently, the vehicle may decelerate.
- If the driver accelerates and releases the accelerator pedal while Navigation-based Smart Cruise Control is operating, the vehicle may not decelerate sufficiently or may rapidly decelerate to a safe speed.
- If the curve is too large or too small, Navigation-based Smart Cruise Control may not operate.

**\* NOTICE**

- A time gap could occur between the navigation's guidance and when Navigation-based Smart Cruise Control operation starts and ends.
- The speed information on the cluster and navigation may differ.
- Even if you are driving at a speed lower than Smart Cruise Control set speed, acceleration may be limited by the curve sections ahead.
- If Navigation-based Smart Cruise Control is operating while leaving the main road to enter an interchange, junction, rest area, etc., the function may operate for a certain period of time.
- Deceleration by Navigation-based Smart Cruise Control may feel it is not sufficient due to road conditions such as uneven road surfaces, narrow lanes, etc.

**This device complies with Industry Canada licence-exempt RSS standard(s).**

Operation is subject to the following conditions:

1. This device may not cause interference, and
2. This device must accept any interference, including interference that may cause undesired operation of the device.
3. Changes or modifications not expressly approved by the party responsible for compliance could void the user's authority to operate the device.

**Lane Following Assist (LFA)**

Lane Following Assist is designed to help detect lane markings and/or vehicles on the road, and assists the driver's steering to help center the vehicle in the lane.

**Detecting sensor**

Front view camera



The front view camera is used as a detecting sensor to detect lane markings and front vehicles.

Refer to the picture above for the detailed location of the detecting sensor.

**⚠ CAUTION**

For more details on the precautions of the front view camera, refer to "Forward Collision-Avoidance Assist (FCA) (Front Camera Only) (if equipped)" on page 6-58.

**Lane Following Assist settings**

**Warning Sound and Haptic**

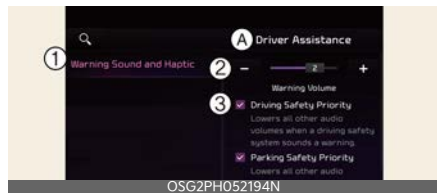

- A: Driver Assistance
- 1 Warning Sound and Haptic
- 2 Warning Volume

### 3 Driving Safety Priority

With the vehicle on, touch **Settings** → **Vehicle** → **Driver Assistance** → **Warning Style** on the infotainment system to change the Warning Style.

- **Warning Volume:** You can adjust the Warning Volume from level 1 to 3. If equipped with steering wheel vibration, the volume level can be set from 0 to 3.
- **Driving Safety Priority:** For safe driving, the audio volume will temporarily decrease to warn the driver with the audible warning.

#### \* NOTICE

- Ensure that Warning Style you have set may apply to the Warning volume of other Driver Assistance systems.
- Warning Style will maintain its last setting even if the vehicle is restarted.
- If not equipped with the navigation system, select **User Settings** → **Driver Assistance** to adjust the Warning Volume.
- The setting menu may not be available for your vehicle depending on the vehicle features and specifications.
- Descriptions of each Driver Assistance system may be slightly different from the owner's manual after updating the software of your infotainment system. In this case, scan the QR code in the infotainment system manual to access the web manual for checking the changes.

### Lane Following Assist operation

#### Turning Lane Following Assist On/Off



With the engine on, shortly press the Lane Driving Assist button located on the steering wheel to turn on Lane Following Assist. The grey or green (LFA) indicator light will appear on the cluster. Press the button again to turn off the function.

#### Lane Following Assist



If the vehicle ahead and/or both lane markings are detected and the vehicle speed is below 160 km/h (90 mph), the green (LFA) indicator light appears on the cluster, and Lane Following Assist helps center the vehicle in the lane by assisting the steering wheel.

#### ⚠ CAUTION

When the steering wheel is not assisted, the white (LFA) indicator light blinks and changes to grey.

### Hands-off warning



#### A: Keep hands on steering wheel

If the driver takes their hands off the steering wheel for several seconds, the warning message will appear and an audible warning will sound in stages.

- First stage: Warning message
- Second stage: Warning message (red steering wheel) and audible warning

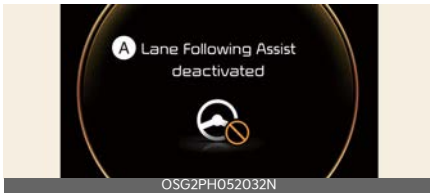

#### A: Lane Following Assist deactivated

If the driver still does not have their hands on the steering wheel after the hands-off warning the warning message will appear and Lane Following Assist will be automatically canceled.

### ⚠ WARNING

- The steering wheel may not be assisted if the steering wheel is held very tight or the steering wheel is steered over a certain degree.
- Lane Following Assist does not operate at all times. It is the responsibility of the driver to safely steer the vehicle and to maintain the vehicle in its lane.
- The hands-off warning message may appear late depending on road conditions. Always have your hands on the steering wheel while driving.

- If the steering wheel is held very lightly the hands-off warning message may appear because Lane Following Assist may not recognize that the driver has their hands on the steering wheel.
- If you attach objects to the steering wheel, the hands-off warning may not work properly.

### \* NOTICE

- When both lane markings are detected, the lane lines on the cluster will change from grey to white.

Lane undetected



Lane detected



- The images and colors in the instrument cluster may differ depending on the cluster type or theme selected from the settings menu.
- If lane markings are not detected, steering wheel control by Lane Following Assist can be limited depending on whether a vehicle is in front or the driving conditions of the vehicle.
- Even though the steering is assisted by Lane Following Assist, the driver may control the steering wheel.

- The steering wheel may feel heavier or lighter when the steering wheel is assisted by Lane Following Assist than when it is not.

### Lane Following Assist malfunction and limitations

### Lane Following Assist malfunction

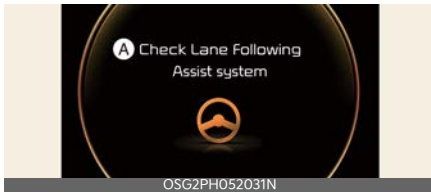

#### A: Check Lane Following Assist system

When Lane Following Assist is not working properly, the warning message will appear and the master warning light (⚠) will appear on the cluster.

If this occurs, have the vehicle inspected by an authorized Kia dealer.

### Limitations of Lane Following Assist

For more details on Lane Following Assist limitations, refer to "Lane Keeping Assist (LKA)" on page 6-80.

## Highway Driving Assist (HDA) (if equipped)

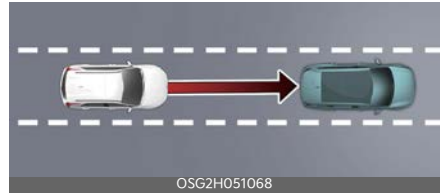

Highway Driving Assist is designed to help detect vehicles and lanes ahead, and help maintain distance from the vehicle ahead, maintain the set speed, help center the vehicle in the lane while driving on the highway (or motorway).

### \* NOTICE

- Highway Driving Assist is available only on controlled access road of certain highways.
- \* Controlled access road indicates roads with limited entrances and exits that allow uninterrupted high speed traffic flow. Only passenger cars and motorcycles are allowed on controlled access roads.

Available highway (Controlled access road)	
USA	Select Interstate Highway and U.S. (Federal) and State Highways
Canada	Select Provincial and Territorial Highways

- Additional highways may be expanded by future navigation updates.
- Highway Driving Assist operates on main roads of highways (or motorways), and does not operate on interchanges or junctions.

## Detecting sensor

Front view camera



OSG2PH042008L

Front radar



OSG2H051022

Refer to the picture above for the detailed location of the detecting sensors.

### ⚠ CAUTION

For more details on the precautions of the detecting sensors, refer to "Forward Collision-Avoidance Assist (FCA) (Sensor Fusion) (if equipped)" on page 6-68.

## Highway Driving Assist settings

### Highway Driving Assist

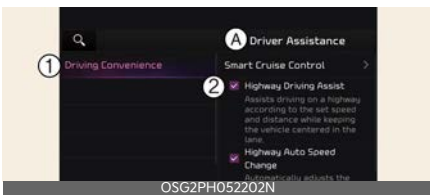

OSG2PH052202N

A: Driver Assistance

1 Driving Convenience

2 Highway Driving Assist

With the vehicle on, touch **Settings** → **Driver Assistance** → **Driving Convenience**

**ence** → **Highway Driving Assist** on the instrument cluster or **Settings** → **Vehicle** → **Driver Assistance** → **Driving Convenience** → **Highway Driving Assist** on the infotainment system.

If **Highway Driving Assist** is selected, it helps maintain distance from the vehicle ahead, maintain the set speed, and helps center the vehicle in the lane.

### ⚠ WARNING

For your safety, change the Settings after parking the vehicle at a safe location.

### \* NOTICE

- If there is a problem with the functions, the settings cannot be changed. Have the vehicle inspected by an authorized Kia dealer.
- If the vehicle is restarted, the functions will maintain the last setting.

### \* INFORMATION

The infotainment system may change after software updates. For more information, refer to the user's manual provided in the infotainment system and the quick reference guide.

## Warning Sound and Haptic

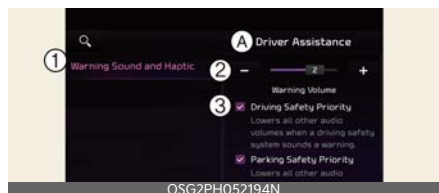

OSG2PH052194N

A: Driver Assistance

1 Warning Sound and Haptic

2 Warning Volume



### 3 Driving Safety Priority

With the vehicle on, touch **Settings** → **Vehicle** → **Driver Assistance** → **Warning Style** on the infotainment system to change the Warning Style.

- **Warning Volume:** You can adjust the Warning Volume from level 1 to 3. If equipped with steering wheel vibration, the volume level can be set from 0 to 3.
- **Driving Safety Priority:** For safe driving, the audio volume will temporarily decrease to warn the driver with the audible warning.

**\* NOTICE**

- Ensure that Warning Style you have set may apply to the Warning volume of other Driver Assistance systems.
- Warning Style will maintain its last setting even if the vehicle is restarted.
- If not equipped with the navigation system, select **User Settings** → **Driver Assistance** to adjust the Warning Volume.
- The setting menu may not be available for your vehicle depending on the vehicle features and specifications.
- Descriptions of each Driver Assistance system may be slightly different from the owner's manual after updating the software of your infotainment system. In this case, scan the QR code in the infotainment system manual to access the web manual for checking the changes.

### Highway Driving Assist operation Displaying operating status

You can see the status of the Highway Driving Assist operation in the Driving

Assist view on the cluster. Refer to "LCD display modes" on page 5-83.

Operating State

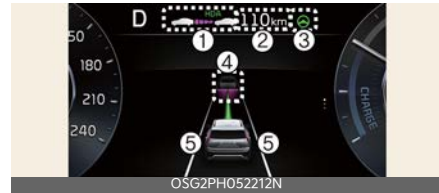

Standby State



Highway Driving Assist will be displayed as below depending on the status of the function.

- 1 Highway Driving Assist indicator, whether there is a vehicle ahead and the selected distance level are displayed.
  - Highway Driving Assist indicator
    - Green **HDA**: Operating state
    - Grey **HDA**: Standby state
    - White **HDA** blink: Accelerator depressed state
- 2 Set speed
- 3 Lane Following Assist indicator
- 4 Whether there is a vehicle ahead and the selected headway
- 5 Whether the lane is detected or not

**\* NOTICE**

- For more details on the display refer to "Smart Cruise Control (SCC) (if equipped)" on page 6-118.

- For more details on the display, refer to "Lane Following Assist (LFA)" on page 6-136.
- The images and colors in the instrument cluster may differ depending on the cluster type or theme selected from the settings menu.

### Highway Driving Assist operating

Highway Driving Assist operates when:

- When driving on available road, press Drive Assist button to turn on Highway Driving Assist.
- When entering the main roads of highways (or motorways) while Smart Cruise Control is operating, Driving Assist will not turn on if Lane Following Assist is turned off.

### Restarting after stopping

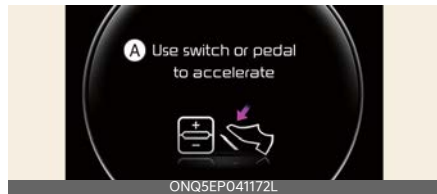

#### A: Use switch or pedal to accelerate

When Highway Driving Assist is operating, your vehicle will stop if the vehicle ahead of you stops. Also, if the vehicle ahead of you starts moving within 30 seconds after the stop, your vehicle will start as well. In addition, after the vehicle has stopped and 30 seconds have passed, the message will appear on the cluster. Depress the accelerator pedal or operate the + switch, - switch or  switch to start driving.

### Hands-off warning



#### A: Keep hands on steering wheel

If the driver takes their hands off the steering wheel for several seconds, the

warning message will appear and an audible warning will sound in stages.

- First stage: Warning message
- Second stage: Warning message (red steering wheel) and audible warning



**A: Highway Driving Assist deactivated**

If the driver still does not have their hands on the steering wheel after the hands-off warning, warning message will appear and Highway Driving Assist will be automatically canceled.

**Driving speed limit**

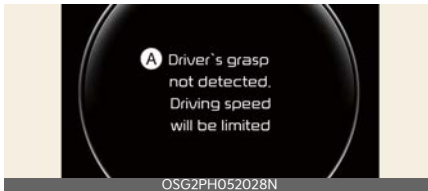

**A: Driver's grasp not detected. Driving speed will be limited**

When Highway Driving Assist is canceled by the hands-off warning, The driving speed will be limited.

While Driving Speed Limit function is operating, the warning message will appear on the cluster, and an audible warning will sound continuously.

**Highway Driving Assist standby**

When the Smart Cruise Control is temporarily canceled while Highway Driving Assist is operating, Highway Driving Assist will be in the standby state. At this time, Lane Following Assist will operate properly.

**\* NOTICE**

- Driving Speed Limit helps you drive below 60 km/h (40 mph). At this time, the vehicle decelerates due to the vehicle ahead. After the vehicle has decelerated, it cannot automatically accelerate.
- Driving Speed Limit will cancel in the following circumstances:
  - When the driver grabs the steering wheel again
  - When the driver turns on Lane Following Assist by pressing the Lane Driving Assist button
  - When (+), (-), (⏪) switch or (🚗) button is operated, or the accelerator pedal or the brake pedal is depressed

**Highway Driving Assist malfunction and limitations**

**Highway Driving Assist malfunction**

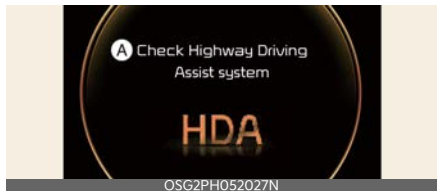

**A: Check Highway Driving Assist system**

When Highway Driving Assist is not working properly, the warning message will appear, and the (⚠️) warning light will appear on the cluster. Have Highway Driving Assist be inspected by an authorized Kia dealer.

**⚠️ WARNING**

- The driver is responsible for controlling the vehicle for safe driving.

- Always have your hands on the steering wheel while driving.
  - Highway Driving Assist is a supplemental function that assists the driver in driving the vehicle and is not a complete autonomous driving system. Always check road conditions, and if necessary, take appropriate actions to drive safely.
  - Always have your eyes on the road, and it is the responsibility of the driver to avoid violating traffic laws. The vehicle manufacturer is not responsible for any traffic violation or accidents caused by the driver.
  - Highway Driving Assist may not be able to recognize all traffic situations. Highway Driving Assist may not detect possible collisions due to limitations of the function. Always be aware of the limitations of the function. Obstacles such as vehicles, motorcycles, bicycles, pedestrians, or unspecified objects or structures such as guardrails, tollgate, etc., that may collide with the vehicle may not be detected.
  - Highway Driving Assist will turn off automatically under the following situations:
    - Driving on roads that Highway Driving Assist does not operate, such as a rest area, intersection, junction, etc.
    - The navigation does not operate properly such as when the navigation is being updated or restarted
  - Highway Driving Assist may inadvertently operate or turn off depending on road conditions (navigation information) and surroundings.
  - Lane Following Assist function may be temporarily disabled when the front view camera cannot detect lanes properly or the hands-off warning is on.
  - You may not hear the warning sound of Highway Driving Assist if the surrounding is noisy.
  - If the vehicle is driven at high speed above a certain speed at a curve, your vehicle may drive to one side or may depart from the driving lane.
  - When you are towing a trailer or another vehicle, turn off Highway Driving Assist for safety reasons.
  - The hands-off warning message may appear early or late depending on how the steering wheel is held or road conditions. Always have your hands on the steering wheel while driving.
  - For your safety, please read the owner's manual before using the Highway Driving Assist.
  - Highway Driving Assist will not operate when the vehicle is started, or when the detecting sensors or navigation is being initialized.
-

## Limitations of Highway Driving Assist

Highway Driving Assist may not operate properly, or it may not operate under the following circumstances:

- The map information and the actual road is different because the navigation is not updated
- The map information and the actual road is different because of real-time GPS data or map information error
- The infotainment system is overloaded by simultaneously performing functions such as route search, video playback, voice recognition, etc.
- GPS signals are blocked in areas such as a tunnel
- The driver goes off course, or resetting the navigation route by changing the destination (including route change according to real-time road traffic information), or canceling the route to the destination
- The vehicle enters a service station or rest area
- Android Auto or Car Play is operating
- The navigation cannot detect the current vehicle position (for example, elevated roads including overpass adjacent to general roads or nearby roads exist in a parallel way)

### \* NOTICE

For more details on the limitations of the front view camera and front radar, refer to "Forward Collision-Avoidance Assist (FCA) (Sensor Fusion) (if equipped)" on page 6-68.

## This device complies with Industry Canada licence-exempt RSS standard(s).

Operation is subject to the following conditions:

1. This device may not cause interference, and
2. This device must accept any interference, including interference that may cause undesired operation of the device.
3. Changes or modifications not expressly approved by the party responsible for compliance could void the user's authority to operate the device.

## Rear View Monitor (RVM)

Rear View Monitor shows the area behind the vehicle to assist you when parking or backing up.

### Detecting sensor

Rear view camera



Refer to the picture above for the detailed location of the detecting sensor.

### Rear View Monitor settings

### Warning Sound and Haptic

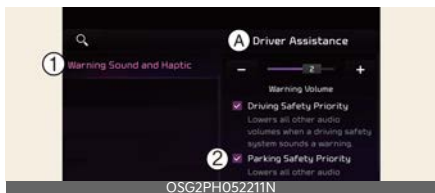

A: **Driver Assistance**

#### 1 Warning Sound and Haptic

#### 2 Parking Safety Priority

With the vehicle on, touch **Settings** → **Vehicle** → **Driver Assistance** → **Warning Style** on the infotainment system to change the Warning Style.

- **Parking Safety Priority:** For safe parking, the audio volume will temporarily decrease while Rear View Monitor is operating.

### \* NOTICE

- If not equipped with the navigation system, select **User Settings** →

**Driver Assistance** to adjust the Warning Volume.

- The setting menu may not be available for your vehicle depending on the vehicle features and specifications.
- Descriptions of each Driver Assistance system may be slightly different from the owner's manual after updating the software of your infotainment system. In this case, scan the QR code in the infotainment system manual to access the web manual for checking the changes.

### Camera settings

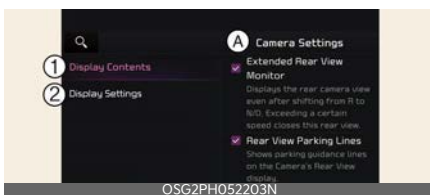

A: **Camera Settings**

#### 1 Display Contents

#### 2 Display Settings

You can change Rear View Monitor 'Display Contents' by touching the setup icon (⚙️) on the screen while Rear View Monitor is operating, or touching **Settings** → **Vehicle** → **Driver assistance** → **Parking safety** → **Camera settings** on the infotainment system

- **Display Contents:** To change the settings of Rear view parking guide and Extended rear camera use.
- **Display Settings:** To change the screen's brightness and contrast.

**\* NOTICE**

The settings menu may not be depending on the specifications of the vehicle specifications.

**\* INFORMATION**

The infotainment system may change after software updates. For more information, refer to the user's manual provided in the infotainment system and the quick reference guide.

**Display Contents**

**Rear View Parking Guide**

**Rear View Parking Guide Lines**



If **Rear View Parking Guide Lines** is selected, the rear view parking guide lines will be displayed at the left side of the infotainment system screen.

**\* NOTICE**

The horizontal guideline shows the distance of 0.5 m (1.6 ft.), 1 m (3.3 ft.) and 2.3 m (7.6 ft.) from the vehicle.

**Top View Parking Guide Lines**



If **Rear View Parking Guide Lines** is selected, the top view parking guide lines will be displayed at the left side of the infotainment system screen.

**\* NOTICE**

The horizontal scale of rear top view parking guide indicates the liftgate opening distance, 1.5 m (4.9 ft.) from the vehicle.

**Extended Rear View Monitor**

If Extended Rear View Monitor is selected, Rear View Monitor keeps displaying the rear view when shifting from R (Reverse) to N (Neutral) or D (Drive). When exceeding a certain speed, the rear view stops displaying.

**Rear View Monitor operation**

**Parking/View button**



Press the Parking/View button (1) to turn on Rear View Monitor.

Press the button again to turn off the function.

### Rear view function

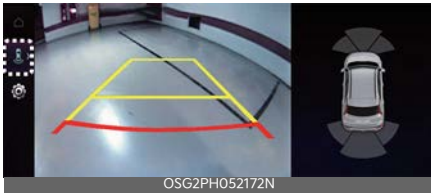

#### Operating conditions

Rear View Monitor will turn on when the following conditions are satisfied:

- Shifting the gear to R (Reverse).
- Pressing the Parking/View button (1) while P (Park) gear position is selected
- Pressing the View icon with the Rear top view on the screen

#### Off conditions

Rear View Monitor will turn off when the following conditions are satisfied:

- Pressing the Parking/View button (1) again while P (Park) gear position is selected. with the rear view on the screen.
- Changing the gear from R (Reverse) to P (Park).

#### \* NOTICE

Rear View Monitor will not turn off when the vehicle is in R (Reverse).

### Extended Rear View Monitor

Extended Rear View Monitor function maintains the rear view of the vehicle when shifting the gear from R (Reverse) to N (Neutral) or D (Drive) to help you park safely.

#### Operating conditions

Rear View Monitor will maintain when the following conditions are satisfied:

- Shifting the gear from R (Reverse) to N (Neutral) or D (Drive).
- The vehicle speed is below approximately 10 km/h (6 mph).

#### Off conditions

Extended Rear View Monitor function will turn off when one the following conditions are satisfied:

- The vehicle speed is above approximately 10 km/h (6 mph).
- Pressing the Parking/View button (1).
- Shifting the gear to P (Park).

### Rear Top View

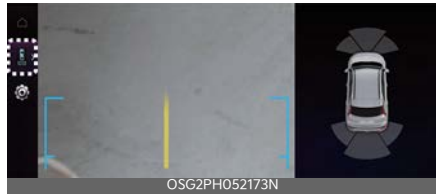

Rear Top View shows the rear top view of your vehicle when parking for you to check the distance between an object and behind the vehicle.

Rear Top View will turn on under the following conditions:

- The gear is shifted to R (Reverse) and the icon is selected among the view buttons.
- The Parking/View button is pressed, while the gear is in P (Park), N (Neutral) or D (Drive), and vehicle speed is 10 km/h (6 mph) or less.

### Rear View Monitor malfunction and limitations

#### Rear View Monitor malfunction

When Rear View Monitor is not working properly, or the screen flickers, or the camera image does not display properly,



have the vehicle inspected by an authorized Kia dealer.

### Limitations of Rear View Monitor

When the vehicle is stopped for a long time in winter or when the vehicle is parked in an indoor parking lot, the exhaust fumes may temporarily blur the image.

#### **⚠ WARNING**

- The rear view camera does not cover the complete area behind the vehicle. The driver should always check the rear area directly through the inside and outside rearview mirror before parking or backing up.
- The image shown on the screen may differ from the actual distance of the object. Make sure to directly check the vehicle's surroundings for safety.
- Always keep the rear view camera lens clean. If the lens is covered with foreign material, it may adversely affect camera performance and Rear View Monitor may not operate properly. However, do not use chemical solvents such as strong detergents containing high alkaline or volatile organic solvents (gasoline, acetone etc.). This may damage the camera lens.

### Rear Cross-Traffic Collision-Avoidance Assist (RCCA) (if equipped)

Rear Cross-Traffic Collision-Avoidance Assist is designed to help detect vehicles approaching from the left and right side while your vehicle is reversing, and warn the driver that a collision is imminent with a warning message and an audible warning. Also, braking is assisted to help prevent collision.

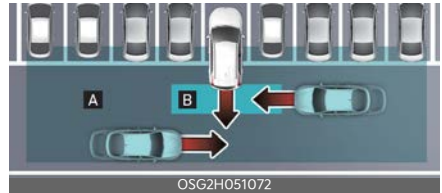

[A]: Rear Cross-Traffic Collision Warning operating range

[B]: Rear Cross-Traffic Collision-Avoidance Assist operating range

#### **⚠ CAUTION**

Warning timing may vary depending on vehicle speed of the approaching vehicle.

### Detecting sensor

Rear corner radar



Refer to the picture above for the detailed location of the detecting sensors.

**\* NOTICE**

For more details on the precautions of the rear corner radar, refer to "Blind-Spot Collision-Avoidance Assist (BCA) (if equipped)" on page 6-85.

**Rear Cross-Traffic Collision-Avoidance Assist settings**

**Rear Cross-Traffic Safety**



A: Driver Assistance

1 Parking Safety

2 Rear Cross-Traffic Safety

With the vehicle on, touch **Settings** → **Driver Assistance** → **Parking Safety** → **Rear Cross-Traffic Safety** from the User settings menu or select **Settings** → **Vehicle** → **Driver Assistance** → **Parking Safety** → **Rear Cross-Traffic Safety** on the infotainment system screen to turn on Rear Cross-Traffic Collision-Avoidance Assist.

**⚠ WARNING**

When the vehicle is restarted, Rear Cross-Traffic Collision-Avoidance Assist will always turn on. However, if **Rear Cross-Traffic Safety** is deselected after the vehicle is restarted, the driver should

always be aware of the surroundings and drive safely.

**\* NOTICE**

If the vehicle is restarted, Warning Volume will maintain the last setting.

**\* INFORMATION**

The infotainment system may change after software updates. For more information, refer to the user's manual provided in the infotainment system and the quick reference guide.

**Warning Sound and Haptic**



A: Driver Assistance

1 Warning Sound and Haptic

2 Warning Volume

With the vehicle on, touch **Settings** → **Vehicle** → **Driver Assistance** → **Warning Style** on the infotainment system to change the Warning Style.

- **Warning Volume:** You can adjust the Warning Volume from level 1 to 3. If equipped with steering wheel vibration, the volume level can be set from 0 to 3.
- **Steering Wheel Vibration Warning:** Steering wheel vibration can be selected. (if equipped)

**\* NOTICE**

- Ensure that Warning Style you have set may apply to the Warning volume of other Driver Assistance systems.
- Warning Style will maintain its last setting even if the vehicle is restarted.
- If not equipped with the navigation system, select **User Settings** → **Driver Assistance** to adjust the Warning Volume.
- The setting menu may not be available for your vehicle depending on the vehicle features and specifications.
- Descriptions of each Driver Assistance system may be slightly different from the owner's manual after updating the software of your infotainment system. In this case, scan the QR code in the infotainment system manual to access the web manual for checking the changes.

**Rear Cross-Traffic Collision-Avoidance Assist operation**

Rear Cross-Traffic Collision-Avoidance Assist will warn and control the vehicle depending on collision risk level:

'Collision warning', 'Emergency braking' and 'Stopping vehicle and ending brake control'.

**Collision warning**



**A: Collision warning**

- To warn the driver of an approaching vehicle from the rear left/right side of your vehicle, the warning light on the outside rearview mirror will blink and a warning will appear on the cluster. At the same time, an audible warning will sound. If the Rear View Monitor is operating, a warning will also appear on the infotainment system screen.
- Rear Cross-Traffic Collision-Avoidance Assist will operate when all the following conditions are satisfied:
  - The gear is shifted to R (Reverse)
  - Vehicle speed is below 8 km/h (5 mph)
  - The approaching vehicle is within approximately 25 m (82 ft.) from the left and right side of your vehicle
  - The speed of the vehicle approaching from the left and right is above 5 km/h (3 mph)

**\* NOTICE**

- If the operating conditions are satisfied, there will be a warning whenever the vehicle approaches from the left or right side even though your vehicle speed is 0 km/h (0 mph).

- The images and colors in the cluster may differ depending on the cluster type or theme selected from the cluster.

## Emergency braking



### A: Emergency Braking

- To warn the driver of an approaching vehicle from the rear left/right side of your vehicle, the warning light on the outside rearview mirror will blink and a warning message will appear on the cluster. At the same time, an audible warning will sound. A warning will also appear on the infotainment system screen.
- Emergency braking will be assisted to help prevent collision with approaching vehicles from the left and right.
- Rear Cross-Traffic Collision-Avoidance Assist will operate when all the following conditions are satisfied:
  - The gear is shifted to R (Reverse)

- Vehicle speed is below 8 km/h (5 mph)
- The approaching vehicle is within approximately 1.5 m (5 ft.) from the left and right side of your vehicle
- The speed of the vehicle approaching from the left and right is above 5 km/h (3 mph)

### **WARNING**

Brake control ends when the conditions of the approaching vehicle from the rear left or right side are as below:

- The approaching vehicle is out of the detecting range
- The approaching vehicle passes behind your vehicle
- The approaching vehicle does not drive toward your vehicle
- The approaching vehicle speed slows down
- The driver depresses the brake pedal with sufficient power

## Stopping vehicle and ending brake control



### A: Drive carefully

- When the vehicle is stopped due to emergency braking, the warning message will appear on the cluster.
- Brake control will end after the vehicle is stopped by emergency braking for approximately 2 seconds.
- During emergency braking, braking control by Rear Cross-Traffic Colli-

sion-Avoidance Assist will automatically cancel when the driver excessively depresses the brake pedal.

### **⚠ WARNING**

- For your safety, change the Settings after parking the vehicle at a safe location.
- If any other function's warning message is displayed or audible warning is generated, Rear Cross-Traffic Collision-Avoidance Assist's warning message may not be displayed and audible warning may not be generated.
- You may not hear the warning sound of Rear Cross-Traffic Collision-Avoidance Assist if the surrounding is noisy.
- Rear Cross-Traffic Collision-Avoidance Assist may not operate if the driver applies the brake pedal to avoid collision.
- During Rear Cross-Traffic Collision-Avoidance Assist operation, the vehicle may stop suddenly injuring passengers and shifting loose objects. Always have the seat belt on and keep loose objects secured.
- Even if there is a problem with Rear Cross-Traffic Collision-Avoidance Assist, the vehicle's basic braking performance will operate properly.

### **⚠ WARNING**

- When Rear Cross-Traffic Collision-Avoidance Assist is operating, braking control by function will automatically cancel when the driver excessively depresses the accelerator pedal.
- Rear Cross-Traffic Collision-Avoidance Assist does not operate in all situations or cannot avoid all collisions.

- Rear Cross-Traffic Collision-Avoidance Assist may warn the driver late or may not warn the driver depending on the road and driving conditions.
- The driver should hold the responsibility to control the vehicle. Do not solely depend on Rear Cross-Traffic Collision-Avoidance Assist. Rather, maintain a safe braking distance, and if necessary, depress the brake pedal to reduce driving speed or to stop the vehicle.
- Never deliberately operate Rear Cross-Traffic Collision-Avoidance Assist on people, animal, objects, etc. It may cause serious injury or death.

### **⚠ WARNING**

The brake control may not operate properly depending on the status of ESC (Electronic Stability Control).

There will only be a warning when:

- The ESC (Electronic Stability Control) warning light is on
- ESC (Electronic Stability Control) is engaged in a different function

### **\* NOTICE**

- If braking is assisted by Rear Cross-Traffic Collision-Avoidance Assist, the driver must immediately depress the brake pedal and check vehicle surroundings.
- After shifting the gear to R (Reverse), braking control will operate once for left and right vehicle approach.

### Rear Cross-Traffic Collision-Avoidance Assist malfunction and limitations

#### Rear Cross-Traffic Collision-Avoidance Assist malfunction



##### A: Check Blind-Spot Safety system

When Rear Cross-Traffic Collision-Avoidance Assist is not working properly, the warning message will appear on the cluster for several seconds, and the master (⚠) warning light will appear on the cluster. If this occurs, have the function be inspected by an authorized Kia dealer.

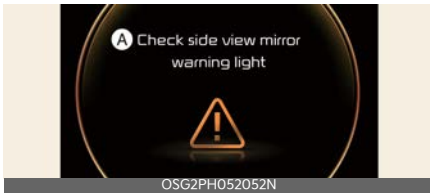

##### A: Check side view mirror warning light

When the outside rearview mirror warning light is not working properly, the warning message will appear on the cluster for several seconds, and the master (⚠) warning light will appear on the cluster. If this occurs, have the function be inspected by an authorized Kia dealer.

### Rear Cross-Traffic Collision-Avoidance Assist disabled

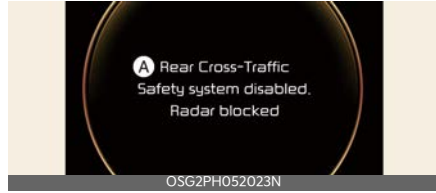

##### A: Rear Cross-Traffic Safety system disabled. Radar blocked

When the rear bumper around the rear-side radar or sensor is covered with foreign material, such as snow or rain, or installing a trailer or carrier, it can reduce the detecting performance and temporarily limit or disable Rear Cross-Traffic Collision-Avoidance Assist.

If this occurs, the warning message will appear on the cluster.

Rear Cross-Traffic Collision-Avoidance Assist will operate properly when such foreign material or trailer, etc., is removed.

If Rear Cross-Traffic Collision-Avoidance Assist does not operate properly after it is removed, have the function be inspected by an authorized Kia dealer.

#### **⚠ WARNING**

- Even though the warning message does not appear on the cluster, Rear Cross-Traffic Collision-Avoidance Assist may not operate properly.
- Rear Cross-Traffic Collision-Avoidance Assist may not operate properly in an area (for example, open terrain), where any substance are not detected after turning ON the vehicle.

**⚠ CAUTION**

Turn off Rear Cross-Traffic Collision-Avoidance Assist to install or remove a trailer, carrier, or another attachment. Turn on Rear Cross-Traffic Collision-Avoidance Assist when finished.

**Limitations of Rear Cross-Traffic Collision-Avoidance Assist**

Rear Cross-Traffic Collision-Avoidance Assist may not operate properly, or it may operate unexpectedly under the following circumstances:

- Departing from where trees or grass are overgrown
- Departing from where roads are wet
- Speed of the approaching vehicle is fast or slow

Braking control may not work, driver's attention is required in the following circumstances:

- The vehicle severely vibrates while driving over a bumpy road, uneven road or concrete patch
- Driving on a slippery surface due to snow, water puddle, ice, etc.
- The tire pressure is low or a tire is damaged
- The brake is tuned
- Remote Smart Parking Assist is operating (if equipped)

**\* NOTICE**

For more details on the limitations of the rear corner radar, refer to "Blind-Spot Collision-Avoidance Assist (BCA) (if equipped)" on page 6-85.

**⚠ WARNING**

- Driving near a vehicle or structure



[A]: Structure

Rear Cross-Traffic Collision-Avoidance Assist may be limited when driving near a vehicle or structure, and may not detect the vehicle approaching from the left or right. If this occurs, the function may not warn the driver or control the brakes when necessary. Always check your surroundings while backing up.

- When the vehicle is in a complex parking environment



Rear Cross-Traffic Collision-Avoidance Assist may detect vehicles which are parking or pulling out near your vehicle (example, a vehicle leaving beside your vehicle, a vehicle parking or pulling out in the rear area, a vehicle approaching your vehicle making a turn, etc.).

If this occurs, the function may unnecessarily warn the driver and control the brake.

Always check your surroundings while backing up.

- When the vehicle is parked diagonally



Rear Cross-Traffic Collision-Avoidance Assist may be limited when backing up diagonally, and may not detect the vehicle approaching from the left or right. If this occurs, the function may not warn the driver or control the brakes when necessary. Always check your surroundings while backing up.

- When the vehicle is on or near a slope



Rear Cross-Traffic Collision-Avoidance Assist may be limited when the vehicle is on an uphill or downhill slope, or near it, and may not detect the vehicle approaching from the left or right. If this occurs, the function may not warn the driver or control the brakes when necessary. Always check your surroundings while backing up.

- Pulling into the parking space where there is a structure

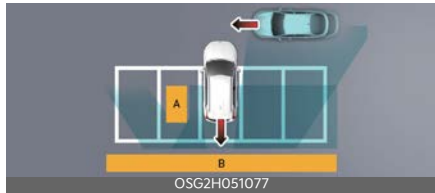

[A]: Structure,  
[B]: Wall

Rear Cross-Traffic Collision-Avoidance Assist may detect vehicles passing by in front of you when parking in reverse into a parking space with a wall or structure in the rear or side area. If this occurs, the function may unnecessarily warn the driver and control the brake.

Always check your surroundings while backing up.

- When the vehicle is parked rearward

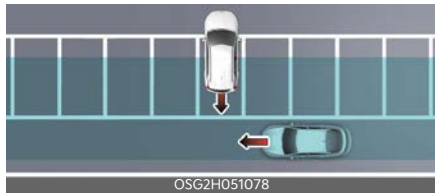

Rear Cross-Traffic Collision-Avoidance Assist may detect vehicles passing by behind you when parking in reverse into a parking space. If this occurs, the function may unnecessarily warn the driver and control the brake.

Always check your surroundings while backing up.



## ⚠️ WARNING

- When you are towing a trailer or another vehicle, turn off Rear Cross-Traffic Collision-Avoidance Assist for safety reasons.
- Rear Cross-Traffic Collision-Avoidance Assist may not operate properly if interfered by strong electromagnetic waves.
- Rear Cross-Traffic Collision-Avoidance Assist may not operate for 3 seconds after the vehicle is started, or the rear corner radars are initialized.

### This device complies with Industry Canada licence-exempt RSS standard(s).

Operation is subject to the following two conditions:

1. This device may not cause interference, and
2. This device must accept any interference, including interference that may cause undesired operation of the device.

## Reverse Parking Distance Warning (PDW) (if equipped)

Reverse Parking Distance Warning will help warn the driver if a person, an animal or an object is detected within a certain distance when the vehicle is moving in reverse.

### Detecting sensor

Rear ultrasonic sensors



Refer to the picture above for the detailed location of the detecting sensors.

### Reverse Parking Distance Warning settings

### Warning Sound and Haptic

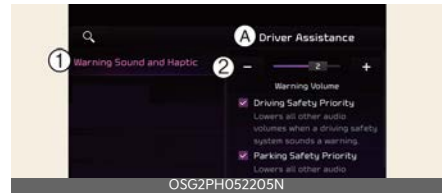

#### A: Driver Assistance

#### 1 Warning Sound and Haptic

#### 2 Warning Volume

With the vehicle on, touch **Settings** → **Vehicle** → **Driver Assistance** → **Warning Style** on the infotainment system to change the Warning Style.

- **Warning Volume:** You can adjust the Warning Volume from level 1 to 3. If equipped with steering wheel vibra-

tion, the volume level can be set from 0 to 3.

- **Steering Wheel Vibration Warning:** Steering wheel vibration can be selected. (if equipped)

**\* NOTICE**

- Ensure that Warning Style you have set may apply to the Warning volume of other Driver Assistance systems.
- Warning Style will maintain its last setting even if the vehicle is restarted.
- If not equipped with the navigation system, select **User Settings** → **Driver Assistance** to adjust the Warning Volume.
- The setting menu may not be available for your vehicle depending on the vehicle features and specifications.
- Descriptions of each Driver Assistance system may be slightly different from the owner's manual after updating the software of your infotainment system. In this case, scan the QR code in the infotainment system manual to access the web manual for checking the changes.

### Reverse Parking Distance Warning operation

#### Parking Safety button



Press the Parking Safety (P+/-) button to turn on or off Reverse Parking Distance Warning.

- When Reverse Parking Distance Warning is off (button indicator light off), if you shift the gear to R (Reverse), Reverse Parking Distance Warning will automatically turn on.
- If you shift the gear to R (Reverse), Reverse Parking Distance Warning will not turn off even if you press the Parking Safety (P+/-) button for your safety.

### Reverse Parking Distance Warning

Reverse Parking Distance Warning will operate under the following conditions.

- Shift the gear to R (Reverse).
- The vehicle's speed is below 10 km/h (6 mph).

### Warning indication and warning sound

Distance from object	Warning indicator when driving backward	Warning sound
60-120 cm (24-48 inches)		Buzzer beeps intermittently
30-60 cm (12-24 inches)		Beeps more frequently
within 30 cm (12 inches)		Beeps continuously

- The corresponding indicator will appear on the cluster or infotainment system whenever each ultrasonic sensor detects a person, animal or object in its sensing range. Also an audible warning will sound.
- When more than two objects are detected at the same time, the closest

one will be warned with an audible warning.

- Distance from object may be detected differently when obstacles are not located in front of the sensor.
- The shape of the indicator in the illustration may differ from the actual vehicle.

### Reverse Parking Distance Warning malfunction and precautions

#### Reverse Parking Distance Warning malfunction

After starting the vehicle, a beep will sound once when the gear is shifted to R (Reverse) to indicate Reverse Parking Distance Warning is operating normally. However, if one or more of the following occurs, first check whether the ultrasonic sensor is damaged or blocked with foreign material. If it still does not work properly, have the vehicle inspected by an authorized Kia dealer.

- The audible warning does not sound.
- The buzzer sounds intermittently.
- The warning message appears on the cluster.



#### A: Ultrasonic sensor error or blockage

#### Limitations of Reverse Parking Distance Warning

- Reverse Parking Distance Warning may not operate normally when:
  - Moisture is frozen to the sensor (Reverse Parking Distance Warn-

ing will operate normally when it is melted.)

- Sensor is covered with foreign material, such as snow or water (Reverse Parking Distance Warning will operate normally when such foreign material are removed.)
- The weather is extremely hot or cold
- The sensor or sensor assembly is disassembled
- The surface of the sensor is pressed hard or an impact is applied with a hard object
- The surface of the sensor is scratched with a sharp object
- The sensors or its surrounding area is directly sprayed with high pressure washer
- Reverse Parking Distance Warning may malfunction when:
  - Heavy rain or water spray is present
  - Water flows on the surface of the sensor
  - Affected by another vehicle's sensors
  - The sensor is covered with snow
  - Driving on uneven road, gravel roads or bushes
  - Objects that generates ultrasonic waves are near the sensor
  - Installing the license plate differently from the original location
  - The vehicle bumper height or ultrasonic sensor installation has been modified
  - Attaching equipments or accessories around the ultrasonic sensors
- The following objects may not be detected:

- Sharp or slim objects, such as ropes, chains or small poles.
- Objects, which tend to absorb sensor frequency, such as clothes, spongy material or snow.
- Objects smaller than 100 cm (40 inches) in length and narrower than 14 cm (6 inches) in diameter.
- Pedestrians, animals or objects that are very close to the ultrasonic sensors

**⚠ WARNING**

- Reverse Parking Distance Warning is a supplemental function. The operation of Reverse Parking Distance Warning can be affected by several factors (including environmental conditions). It is the responsibility of the driver to always check the rear view before and while parking.
- Your vehicle warranty does not cover any accidents or damage to the vehicle due to the malfunction of Reverse Parking Distance Warning.
- Pay close attention when driving near objects, pedestrians, and especially children. Some objects may not be detected by the ultrasonic sensors, due to the objects distance, size or material, all of which can limit the effectiveness of the sensor.
- Parking Distance Warning indicator may not occur sequentially depending on vehicle speed or obstacle shape.
- If Reverse Parking Distance Warning needs repair, have the vehicle inspected by an authorized Kia dealer.

### Forward/Reverse Parking Distance Warning (PDW) (if equipped)

Forward/Reverse Parking Distance Warning will help warn the driver if an obstacle is detected within a certain distance when the vehicle is moving forward or in reverse at low speeds.

#### Detecting sensor

Front ultrasonic sensors



Rear ultrasonic sensors



Refer to the picture above for the detailed location of the detecting sensors.

## Forward/Reverse Parking Distance Warning settings

### Warning Sound and Haptic



#### A: Driver Assistance

##### 1 Warning Sound and Haptic

##### 2 Warning Volume

With the vehicle on, touch **Settings** → **Vehicle** → **Driver Assistance** → **Warning Style** on the infotainment system to change the Warning Style.

- **Warning Volume:** You can adjust the Warning Volume from level 1 to 3. If equipped with steering wheel vibration, the volume level can be set from 0 to 3.
- **Steering Wheel Vibration Warning:** Steering wheel vibration can be selected. (if equipped)

#### \* NOTICE

- Ensure that Warning Style you have set may apply to the Warning volume of other Driver Assistance systems.
- Warning Style will maintain its last setting even if the vehicle is restarted.
- If not equipped with the navigation system, select **User Settings** → **Driver Assistance** to adjust the Warning Volume.
- The setting menu may not be available for your vehicle depending on the vehicle features and specifications.

- Descriptions of each Driver Assistance system may be slightly different from the owner's manual after updating the software of your infotainment system. In this case, scan the QR code in the infotainment system manual to access the web manual for checking the changes.

### Parking Distance Warning Auto On

You can set the parking distance warning to be ON at low speeds. To use Parking Distance Warning Auto On function, select **Settings** → **Driver Assistance** → **Parking Safety** → **Parking Distance Warning Auto On** on the instrument cluster or **Settings** → **Vehicle** → **Driver Assistance** → **Parking Safety** → **Parking Distance Warning Auto On** on the infotainment system.

#### \* NOTICE

When **Parking Distance Warning Auto On** is selected, the Parking Safety button indicator (P<sub>A</sub>) stays on.

### Parking Distance Warning operation

#### Control switch

#### Parking Safety button



- Press the Parking Safety (P<sub>A</sub>) button to turn on Forward/Reverse Parking Distance Warning. Press the button again to turn off the function.

- When the gear is shift to R (Reverse), Parking Distance Warning will automatically turn on (Parking Safety button indicator on).
- When the gear is in R (Reverse), Parking Distance Warning does not turn off even if the Parking Safety button (3) is pressed.

### Forward Parking Distance Warning

Forward Parking Distance Warning will operate under the following conditions.



- The gear is shifted from R (Reverse) to D (Drive) with Reverse Parking Distance Warning on
- The gear is in D (Drive) and the Parking Safety (PWA) button indicator light is on
- Forward Parking Distance Warning warns the driver when the vehicle is in D (Drive)  
(If **Settings** → **Driver Assistance** → **Parking Safety** → **Parking Distance Warning Auto On** on the instrument cluster or **Settings** → **Vehicle** → **Driver Assistance** → **Parking Safety** → **Parking Distance Warning Auto On** on the infotainment system selected)
- Vehicle speed is below 10 km/h (6 mph).

#### \* NOTICE

- Forward Parking Distance Warning does not operate when the vehicle's forward speed is above 10 km/h (6 mph) even when the Parking Safety (PWA) button indicator is on. Forward Parking Distance Warning will operate again when the vehicle's forward speed decreases below 10 km/h (6 mph) while the Parking Safety (PWA) button indicator is on.

- When the vehicle's forward speed is above 30 km/h (18 mph), the Forward Parking Distance Warning will turn off (Parking Safety button indicator off). Although you drive below 10 km/h (6 mph) again, Forward Parking Distance Warning will not automatically turn on (If **Settings** → **Driver Assistance** → **Parking Safety** → **Parking Distance Warning Auto On** on the instrument cluster or **Settings** → **Vehicle** → **Driver Assistance** → **Parking Safety** → **Parking Distance Warning Auto On** on the infotainment system not selected).

### Warning indication and warning sound

Distance from object	Warning indicator when driving forward	Warning sound
60-100 cm (24-40 inches)		Buzzer beeps intermittently
30-60 cm (12-24 inches)		Beeps more frequently
within 30 cm (12 inches)		Beeps continuously

- The corresponding indicator will appear whenever each ultrasonic sensor detects a person, animal or object in its sensing range. Also an audible warning will sound.
- When more than two objects are detected at the same time, the closest one will be warned with an audible warning.

## Driving your vehicle

- The shape of the indicator in the illustration may differ from the actual vehicle.

## Reverse Parking Distance Warning



Reverse Parking Distance Warning will operate under the following conditions.

- The gear is shifted to R (Reverse).
- Vehicle speed is below 10 km/h (6 mph).

### \* NOTICE

Parking Distance Warning detects and warns the driver of both rear and front corners, when the vehicle speed is below 10 km/h (6 mph).

## Warning indication and warning sound

Distance from object	Warning indicator when driving backward	Warning sound
60-120 cm (24-48 inches)		Buzzer beeps intermittently
30-60 cm (12-24 inches)		Beeps more frequently
within 30 cm (12 inches)		Beeps continuously

- The corresponding indicator will appear whenever each ultrasonic sensor detects a person, animal or object in its sensing range. Also an audible warning will sound.
- When more than two objects are detected at the same time, the closest one will be warned with an audible warning.

## Forward/Reverse Parking Distance Warning (PDW)

- The shape of the indicator in the illustration may differ from the actual vehicle.

## Parking Distance Warning malfunction and limitations

### Parking Distance Warning malfunction

After starting the vehicle, a beep will sound when the gear is shifted to R (Reverse) to indicate Parking Distance Warning is operating properly.

However, if one or more of the following occurs, first check whether the ultrasonic sensor is damaged or blocked with foreign material. If it still does not work properly, have the vehicle inspected by an authorized Kia dealer.

- The direction of Parking Distance Warning sensor malfunction is shown on the instrument cluster.



A: Ultrasonic sensor error or blockage

### Parking Distance Warning disabled

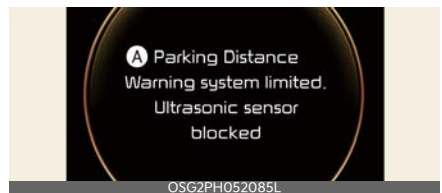

A: Parking Distance Warning system limited. Ultrasonic sensor blocked

If this occurs, the warning message appears on the cluster. Parking Distance Warning will operate properly when

snow, rain or foreign material is removed. If Parking Distance Warning does not operate properly after obstruction (snow, rain, or foreign material) is removed (including trailer, carrier, etc., from the rear bumper), have the vehicle inspected by an authorized Kia dealer.

### Limitations of Parking Distance Warning

- Parking Distance Warning may not operate properly when:
  - Moisture is frozen to the sensor
  - Sensor is covered with foreign substance, such as snow or water (Parking Distance Warning will operate properly when such substance is removed.)
  - The weather is extremely hot or cold
  - The sensor or sensor assembly is disassembled
  - The surface of the sensor is pressed hard or hit with a hard object
  - The surface of the sensor is scratched with a sharp object
  - The sensors or its surrounding area is directly sprayed with high pressure washer
- Parking Distance Warning may malfunction when:
  - Heavy rain or water spray is present
  - Water flows on the surface of the sensor
  - Affected by another vehicle's sensors
  - The sensor is covered with snow or ice
  - Driving on uneven road, gravel roads or bushes

- Objects that generates ultrasonic waves are near the sensor
- License plate is installed in a different spot from the original location
- The vehicle bumper height or ultrasonic sensor installation has been modified
- Attaching equipment or accessories next to the ultrasonic sensors
- The following objects may not be detected:
  - Sharp or slim objects, such as ropes, chains or small poles.
  - Narrow objects, such as corners of a square column
  - Objects, which tend to absorb sensor frequency, such as clothes, spongy material or snow.
  - Objects smaller than 100 cm (40 inches) in length and narrower than 14 cm (6 inches) in diameter.
  - Pedestrians, animals or objects that are very close to the ultrasonic sensors

### **WARNING**

- Parking Distance Warning is a supplemental function. The operation of Parking Distance Warning can be affected by several factors (including environmental conditions). It is the responsibility of the driver to always check the front and rear views before and while parking.
- Your new vehicle warranty does not cover any accidents or damage to the vehicle due to the malfunction of Parking Distance Warning.
- Pay close attention when driving near objects, pedestrians, and especially children. Some objects may not be detected by the ultrasonic sensors, due to the objects distance, size or



material, all of which can limit the effectiveness of the sensor.

- Parking Distance Warning does not warn you in the order of detection. It varies depending on the speed of the vehicle or the shape of a person, animal, or object.
- If the Parking Distance Warning does not operate properly, have the vehicle inspected by an authorized Kia dealer.

## Reverse Parking Collision-Avoidance Assist (PCA) (if equipped)

Reverse Parking Collision-Avoidance Assist can warn the driver or assist with braking to help reduce the possibility of collision with a pedestrian or an object while driving at low speed.

### Detecting sensor

Rear view camera



Rear ultrasonic sensors



### Parking Collision-Avoidance Assist settings

#### Parking Safety

With the vehicle on, touch **Settings** → **Vehicle** → **Driver Assistance** → **Parking Safety** on the infotainment system.

- **Rear safety:** Reverse Parking Collision-Avoidance Assist will warn the driver and assist with braking when a collision with a pedestrian or an object is imminent.

**\* NOTICE**

Rear safety will be selected and Parking Collision-Avoidance Assist settings will be retained whenever the vehicle is restarted.

**Turning Parking Collision Avoidance Assist On/Off**



OSG2PH052011L

Press and hold the Parking Safety (PWA) button more than 2 seconds, 'Rear Active Assist' or to turn the Parking Collision-Avoidance Assist on or off.

**Rear Safety settings**



OSG2PH052206N

**A: Driver Assistance**

**1 Parking Safety**

**2 Rear Safety**

With the vehicle on, touch **Settings** → **Vehicle** → **Driver Assistance** → **Parking Safety** → **Rear Safety** on the infotainment system to set the Rear Safety.

**\* NOTICE**

- If the vehicle is restarted, Warning volume will maintain the last setting.

- If you change the Warning volume, the Warning volume of other Driver Assistance systems may change.

**\* INFORMATION**

The infotainment system may change after software updates. For more information, refer to the user's manual provided in the infotainment system and the quick reference guide.

**Warning Sound and Haptic**

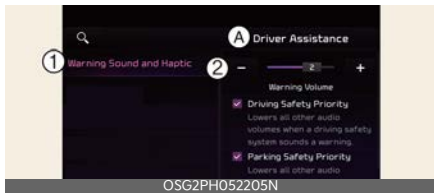

OSG2PH052205N

**A: Driver Assistance**

**1 Warning Sound and Haptic**

**2 Warning Volume**

With the vehicle on, touch **Settings** → **Vehicle** → **Driver Assistance** → **Warning Style** on the infotainment system to change the Warning Style.

- **Warning Volume:** You can adjust the Warning Volume from level 1 to 3. If equipped with steering wheel vibration, the volume level can be set from 0 to 3.
- **Steering Wheel Vibration Warning:** Steering wheel vibration can be selected. (if equipped)

**\* NOTICE**

- Ensure that Warning Style you have set may apply to the Warning volume of other Driver Assistance systems.
- Warning Style will maintain its last setting even if the vehicle is restarted.

- If not equipped with the navigation system, select **User Settings** → **Driver Assistance** to adjust the Warning Volume.
- The setting menu may not be available for your vehicle depending on the vehicle features and specifications.
- Descriptions of each Driver Assistance system may be slightly different from the owner's manual after updating the software of your infotainment system. In this case, scan the QR code in the infotainment system manual to access the web manual for checking the changes.

## Parking Collision-Avoidance Assist operation

### Operating conditions

Select 'Rear Safety' from the 'Parking Safety' menu of the infotainment system. Parking Collision-Avoidance Assist is enabled when the following conditions are satisfied:

- The liftgate and door are closed
- The Electronic Parking Brake (EPB) is released
- A trailer is not connected
- The gear is shifted to R (Reverse)
- Vehicle speed is below 10 km/h (6 mph) (detecting pedestrians)
- Vehicle speed is below 4 km/h (2 mph) (detecting objects)
- Parking Collision-Avoidance Assist components such as the rear view camera and the rear ultrasonic sensors are in normal conditions



When Parking Collision-Avoidance Assist activates, a line appears behind the vehicle image in the instrument cluster.

### \* NOTICE

Parking Collision-Avoidance Assist operates only once after shifting the gear to R (Reverse). To reactivate Parking Collision-Avoidance Assist, shift the gear from another gear to R (Reverse).

## Parking Collision-Avoidance Assist

If Parking Collision-Avoidance Assist detects a risk of collision around the vehicle with a pedestrian or an object, Parking Collision-Avoidance Assist will warn the driver with an audible warning and warning message on the instrument cluster. If the infotainment screen is on, a warning will appear on the screen.

If collision is imminent, Parking Collision-Avoidance Assist will assist you with braking.

Braking assist is released after 5 minutes. Immediately depress the brake pedal and check vehicle surroundings.

Braking assist is also released in the following conditions when:

- The gear is shifted to P (Park) or D (Drive)
- The brake pedal is depressed with sufficient power

**\* NOTICE**

When Parking Collision-Avoidance Assist is activated while reversing, braking control will be released after 5 minutes and the Electronic Parking Brake (EPB) will be engaged.

**Parking Collision-Avoidance Assist malfunction and limitations**

**Parking Collision-Avoidance Assist malfunction**

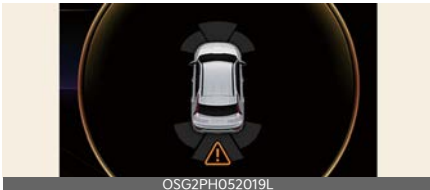

OSG2PH052019L

When Parking Collision-Avoidance Assist or other related functions are not working properly, the warning message will appear on the cluster, and Parking Collision-Avoidance Assist will turn off automatically. Have the vehicle inspected by an authorized Kia dealer.

**Parking Collision-Avoidance Assist disabled**

**Rear view camera**



OSG2H051070

The wide angle cameras are used as detecting sensors to detect pedestrians. If the camera lens is covered with foreign material, such as snow or rain, it may adversely affect camera perfor-

**Reverse Parking Collision-Avoidance Assist (PCA)**

mance and Parking Collision-Avoidance Assist may not operate properly. Always keep the camera lens clean.

**Rear ultrasonic sensors**



OSG2H051079

The ultrasonic sensors detect objects around the vehicle. If the sensors are covered with foreign material, such as snow or rain, it may adversely affect sensor performance and Parking Collision-Avoidance Assist may not operate properly. Always keep the rear bumper clean.

**Warning message**

**Rear view camera**

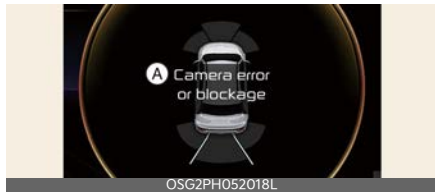

OSG2PH052018L

**A: Camera error or blockage**

**Rear ultrasonic sensors**

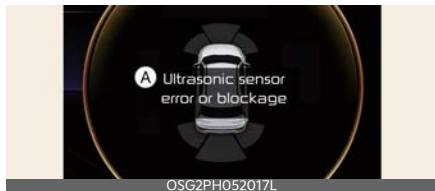

OSG2PH052017L

**A: Ultrasonic sensor error or blockage**

The warning message will appear on the cluster if the following situations occur:

- The camera(s) or ultrasonic sensor(s) is covered with foreign material, such as snow or rain, etc.
- There is inclement weather, such as heavy snow, heavy rain, etc.

If this occurs, Parking Collision-Avoidance Assist may turn off or may not operate properly. Check whether the cameras and ultrasonic sensors are clean.

### **Limitations of Parking Collision-Avoidance Assist**

Parking Collision-Avoidance Assist may not assist braking or warn the driver even if there are pedestrians or objects under the following circumstances:

- There is a problem with the vehicle
- Any non-factory equipment or accessory is installed
- Your vehicle is unstable due to an accident or other causes
- Bumper height or rear ultrasonic sensor installation has been modified
- Wide view camera(s) or ultrasonic sensor(s) is damaged
- Wide view camera(s) or the ultrasonic sensor(s) is stained with foreign material, such as snow, dirt, etc.
- There is a problem with the surroundings
- Wide view camera(s) is obscured by a light source or by inclement weather, such as heavy rain, fog, snow, etc.
- The surrounding is very bright or very dark
- Outside temperature is very high or very low
- The wind is either strong (above 20 km/h (12 mph)) or blowing perpendicular to the rear bumper

- Objects generating excessive noise, such as vehicle horns, loud motorcycle vehicles or truck air brakes, are near your vehicle
- An ultrasonic sensor with similar frequency is near your vehicle
- The road is slippery or inclined
- There is a problem with the pedestrians or objects
- The pedestrians are difficult to detect
- There is ground height difference between the vehicle and the pedestrian
- The image of the pedestrian in the front view camera is indistinguishable from the background
- The pedestrian is near the rear edge of the vehicle
- The pedestrian is not standing upright
- The pedestrian is either very short or very tall to detect
- The pedestrian or cyclist is wearing clothing that easily blends into the background, making it difficult to detect
- The pedestrian is wearing clothing that does not reflect ultrasonic waves well
- Size, thickness, height, or shape of the object does not reflect ultrasonic waves well (for example, pole, bush, curbs, carts, edge of a wall, etc.)
- The pedestrian or the object is moving
- The pedestrian or the object is very close to the rear of the vehicle
- There is a large object such as a wall is behind the pedestrian or the object
- The object is not located at the front or rear center of your vehicle
- The object is not parallel to the rear bumper

## Driving your vehicle

- There is a problem with the driving conditions
- The driver drives the vehicle immediately after shifting to R (Reverse) or D (Drive)
- The driver accelerates or circles the vehicle

Parking Collision-Avoidance Assist may unnecessarily warn the driver or assist with braking even if there are no pedestrians or objects under the following circumstances:

- There is a problem with the vehicle
- Any non-factory equipment or accessory is installed
- Your vehicle is unstable due to an accident or other causes
- Bumper height or rear ultrasonic sensor installation has been modified
- Your vehicle height is low or high due to heavy loads, abnormal tire pressure, etc.
- Wide view camera(s) or the rear ultrasonic sensor(s) is stained with foreign material, such as snow, dirt, etc.
- There is a problem with the surroundings
- The pattern on the road is mistaken for a pedestrian
- There is shadow or light reflecting on the ground
- Pedestrians or objects are around the path of the vehicle
- Objects generating excessive noise, such as vehicle horns, loud motorcycle vehicles or truck air brakes, are near your vehicle
- Your vehicle is backing towards a narrow passage or parking space
- Your vehicle is backing towards an uneven road surface, such as an

## Reverse Parking Collision-Avoidance Assist (PCA)

unpaved road, gravel, bump, gradient, etc.

- A trailer or carrier is installed on the rear of your vehicle
- An ultrasonic sensor with similar frequency is near your vehicle
- An ultrasonic sensor with similar frequency is near your vehicle

### **WARNING**

- Always pay extreme caution while driving. The driver is responsible for controlling the brake for safe driving.
- Always look around your vehicle to make sure there are no pedestrians or objects before moving the vehicle.
- The performance of Parking Collision-Avoidance Assist may vary under certain conditions. If vehicle speed is above 4 km/h (2 mph), Parking Collision-Avoidance Assist will provide collision avoidance assist only when pedestrians are detected. Always look around and pay attention when driving your vehicle.
- Some objects may not be detected by the rear ultrasonic sensors due to the objects distance, size or material, all of which can limit the effectiveness of the sensor.
- Parking Collision-Avoidance Assist may not operate properly or may operate unnecessarily depending on the road conditions and the surroundings.
- Do not solely rely on Parking Collision-Avoidance Assist. Doing so may lead to vehicle damage or injuries.
- Always keep the wide angle cameras and ultrasonic sensors clean.
- Do not use any cleanser containing acid or alkaline detergents when cleaning the camera lens. Use only a

mild soap or neutral detergent, and rinse thoroughly with water.

- Do not spray the wide angle cameras or the rear ultrasonic sensors or their surrounding area directly with a high pressure washer. It may cause the wide angle cameras or the ultrasonic sensors to malfunction.
- Do not apply objects, such as a bumper sticker or a bumper guard, near the wide angle cameras or ultrasonic sensors or apply paint to the bumper. Doing so may adversely affect the performance of Parking Collision-Avoidance Assist.
- Never disassemble or apply impact on the wide angle cameras or the ultrasonic sensors components.
- Do not apply unnecessary force on the wide angle cameras or the ultrasonic sensors. Parking Collision-Avoidance Assist may not operate properly if the wide angle cameras or the ultrasonic sensor(s) is forcibly moved out of proper alignment. Have the vehicle inspected by an authorized Kia dealer.
- Noise may be heard when sudden braking occurs to avoid a collision.
- If any other warning sound such as the seat belt warning chime is already generated, Parking Collision-Avoidance Assist warning may not sound.
- Parking Collision-Avoidance Assist may not work properly if the bumper has been damaged, replaced or repaired.
- Parking Collision-Avoidance Assist may not operate properly if interfered by strong electromagnetic waves.
- Playing the vehicle audio system at high volume may prevent passengers

from hearing Parking Collision-Avoidance Assist warning sounds.

- The brake control may not operate properly depending on the status of ESC (Electronic Stability Control). There will only be a warning when:
  - The ESC (Electronic Stability Control) warning light is on
  - ESC (Electronic Stability Control) is engaged in a different function
- Check your brake fluid and brake pad conditions regularly. The brake performance may decrease depending on brake conditions.

---

### **\* NOTICE**

Parking Collision-Avoidance Assist can detect a pedestrian or an object when:

- A pedestrian is standing behind the vehicle
  - A large obstacle, such as a vehicle, is parked in the rear center of your vehicle
-

## Remote Smart Parking Assist (RSPA) (if equipped)

Remote Smart Parking Assist uses vehicle sensors to help the driver park and exit parking spaces remotely from outside the vehicle by controlling the steering wheel, vehicle speed and gearshifts.

Function	Description
Remote Operation	Remotely moving forward or backward 

- Remote Operation function may be operated from outside the vehicle using the smart key.
- When Remote Smart Parking Assist operates, Parking Distance Warning and Rear View Monitor will also operate. For more details, refer to "Forward/Reverse Parking Distance Warning (PDW) (if equipped)" on page 6-160, and "Rear View Monitor (RVM)" on page 6-146.

### Detecting sensor

Front ultrasonic sensors



Front side ultrasonic sensors



Rear side ultrasonic sensors



Rear ultrasonic sensors



Refer to the picture above for the detailed location of the detecting sensors.

### ⚠ CAUTION

- Never disassemble the detecting sensor or sensor assembly, or cause any damage to it.
- If the detecting sensors need repair, have your vehicle inspected by an authorized Kia dealer.
- Remote Smart Parking Assist may malfunction if the vehicle bumper height or ultrasonic sensor installation has been modified or damaged. Any non-factory installed equipment or accessories may also interfere with the sensor performance.
- When the ultrasonic sensor is frozen or stained with snow, dirt, or water, the sensor may be not operate until the stains are removed using a soft cloth.
- Do not push, scratch or strike the ultrasonic sensor. Sensor damage could occur.



- Do not spray the ultrasonic sensors or its surrounding area directly with a high pressure washer.

## Remote Smart Parking Assist settings

### Warning Sound and Haptic

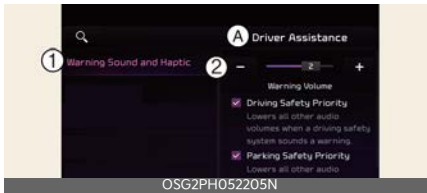

#### A: Driver Assistance

##### 1 Warning Sound and Haptic

##### 2 Warning Volume

With the vehicle on, touch **Settings** → **Vehicle** → **Driver Assistance** → **Warning Style** on the infotainment system to change the Warning Style.

- **Warning Volume:** You can adjust the Warning Volume from level 1 to 3. If equipped with steering wheel vibration, the volume level can be set from 0 to 3.
- **Steering Wheel Vibration Warning:** Steering wheel vibration can be selected. (if equipped)

#### \* NOTICE

- Ensure that Warning Style you have set may apply to the Warning volume of other Driver Assistance systems.
- Warning Style will maintain its last setting even if the vehicle is restarted.
- If not equipped with the navigation system, select **User Settings** → **Driver Assistance** to adjust the Warning Volume.

- The setting menu may not be available for your vehicle depending on the vehicle features and specifications.
- Descriptions of each Driver Assistance system may be slightly different from the owner's manual after updating the software of your infotainment system. In this case, scan the QR code in the infotainment system manual to access the web manual for checking the changes.

## Remote Smart Parking Assist operation

### Remote Smart Parking Assist button

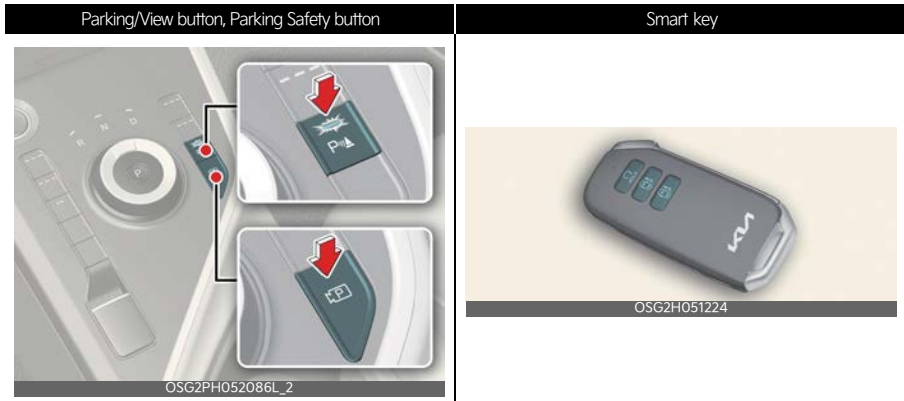

Location	Name	Symbol	Description
Inside vehicle	Parking/View button		<ul style="list-style-type: none"> <li>Press and hold the Parking/View button to turn on Remote Smart Parking Assist. Also, Forward/Reverse Parking Distance warning will automatically turn on.</li> </ul>
	Parking Safety button		<ul style="list-style-type: none"> <li>Press the Parking Safety button while Remote Smart Parking Assist is operating to end function operation.</li> </ul>
Smart key	Remote Start button		<ul style="list-style-type: none"> <li>Press the Remote Start button after the door is locked with the vehicle off to start the vehicle remotely.</li> <li>Press the Remote Start button while Remote Operation function is operating to end function operation.</li> </ul>
	Forward button		<ul style="list-style-type: none"> <li>When using the Remote Operation function, the vehicle moves in the direction of the button while the button is pressed.</li> </ul>
	Backward button		

## Remote Operation

### Operating order

Remote Operation operates in the following order:

1. Getting ready to remotely move forward and backward
2. Remotely moving forward and backward

### 1. Getting ready to remotely move forward and backward

There are two ways to operate Remote Operation function.

Method (1): Using the function with vehicle off



1. Within a certain range from the vehicle press the door lock (🔒) button on the smart key and lock all doors.
2. Press and hold the Remote Start button (🔁<sub>HOLD</sub>) within 4 seconds until the vehicle starts.

\* For more details on remotely starting the vehicle, refer to "Remote start (5) (if equipped)" on page 5-7.

Method (2): Using the function with vehicle on



### A: REMOTE Parking instructions

- 1. Leave vehicle (keep the smart key). Close all doors.**
- 2. Press and hold the Forward or Backward button on the smart Key.**
  1. Park the vehicle in front of the space where you want to use Remote Operation function, and shift the gear to P (Park).
  2. Press and hold the Parking/View (P) button to turn on Smart Parking Assist. A message will appear on the infotainment system screen.
  3. Get out of the vehicle with the smart key and close all doors.

### \* NOTICE

'Agree' must be selected on the infotainment system screen and the infotainment system has to operate properly to use Remote Operation function.

### \* INFORMATION

The infotainment system may change after software updates. For more information, refer to the user's manual provided in the infotainment system and the quick reference guide.

## 2. Remote Operation



1. Press and hold one of the Forward (⏪) or Backward (⏩) button on the smart key.
  - Remote Smart Parking Assist will automatically control the steering wheel, vehicle speed and gear shift. The vehicle will move in the direction of the button pressed.
  - While Remote Operation function is operating, if the you let the button, the vehicle will stop and function control will pause. The function will start operating again when the button is pressed and held again.
2. Hold down the Forward (⏪) or Backward (⏩) button until the vehicle reaches the target location.
3. When Remote Operation is done, get in the vehicle with the smart key or press the Remote Start (⏻) button on the smart key from outside the vehicle.
  - The message will appear on the infotainment system screen. The vehicle will automatically shift to P (Park) and engage the parking brake.
  - When the Remote Start (⏻) button is pressed, the vehicle will turn off. If the driver is in the vehicle, the vehicle will retain ON position.

### \* NOTICE

- Remote Operation can control the vehicle remotely using the smart key outside the vehicle.
- Check that all smart keys are outside the vehicle when using Remote Operation function.
- Remote Operation function will operate only when the smart key is within 4 m (13 ft.) from the vehicle. If there is no vehicle movement even when the Forward or Backward button is pressed on the smart key, check the distance to the vehicle and press the button again.
- The detecting range of the smart key may vary depending on the surroundings that are affected by radio waves such as transmission tower, broadcast station, etc.
- When remotely moving forward using method (1), it is recognized as an exit situation, and the vehicle moves 4 m (13 ft.) to check for pedestrians, animals or objects around the vehicle. After confirmation, the steering wheel is controlled according to the condition ahead.
- When remotely moving forward using method (2), it is recognized as a parking situation, and will immediately control the steering wheel according to the condition ahead to assist with entering the parking space and aligning the vehicle. However, performance may reduce depending on the pedestrians, animals, shape of objects, location, etc., around the vehicle.
- For moving remotely backward, both method (1) and (2) aligns the steering

wheel first, and then will only move the vehicle straight.

**⚠ WARNING**

- When using Remote Operation function, make sure that all passengers have gotten out of the vehicle.
- If the vehicle's battery is discharged or Remote Smart Parking Assist malfunctions when parked in a narrow parking space, Remote Operation function will not operate. Always park your vehicle in a space wide enough for you to get in or out of your vehicle.
- Please note that depending on the parking space, you may not be able to exit from the space you have entered by using Remote Operation function.
- After parking, the surrounding may change due to the movement of surrounding vehicles. If this occurs, Remote Operation function may not operate.
- Before leaving the vehicle, close windows and sunroofs, and make sure the vehicle is off before locking the doors.

**Remote Operation function operation status**

Operation Status	Smart key LED	Hazard warning light
Under control	Green LED continuously blinks	-
Pause	Red LED continuously blinks	Blinks
Off	Red LED appears for 4 seconds and then turns off	Blinks 3 times and turns off
Complete	Green LED appears for 4 seconds and then turns off	Blinks 3 times and turns off

**\* NOTICE**

- Operation status by the hazard warning light may not be applicable based on the regulation of your country.
- If the smart key is not within the operating range from the vehicle (approximately 4m (13 ft.)), the smart key LED will not appear or blink. Use the smart key within the operating range.

**How to turn off Remote Operation function while operating**

- Press the Parking/View (P) button or shift the gear except to P (Park) while the infotainment system screen guides the driver using method 2.
- Press the Parking Safety (P) button or select 'Cancel' on the infotainment system screen.
- Press the Remote Start (HOLD) button on the smart key while the vehicle is being controlled by Remote Operation function. Remote Operation function

will turn off. At this time, the vehicle will turn off.

- Get on the vehicle with the smart key. Remote Operation function will turn off. At this time, the vehicle will remain on.

### Remote Smart Parking Assist will pause in the following conditions when:

When Remote operation function is paused, the vehicle will stop. If the condition that made the function to pause disappears, the function may operate again.

- There is a pedestrian, animal or object in the direction the vehicle is moving
- The door or liftgate is open
- The Forward (⏪) or Backward (⏩) button is not continuously pressed
- Simultaneously pressing multiple buttons on a smart key
- The smart key is not operated within 13 ft. (4 m) from the vehicle
- Button of another smart key is pressed in addition to the operating smart key (Excluding start button)
- Blind-Spot Collision-Avoidance Assist or Rear Cross-Traffic Collision-Avoidance Assist operates while the vehicle is being controlled in the reverse direction.
- The vehicle moves 22 ft. (7 m) while the smart key is pressed with Remote Operation function (maximum travel distance per button press)

### Remote Smart Parking Assist will cancel in the following conditions when:

When Remote Operation function is canceled, the vehicle will automatically stop, shift the gear to P (Park) and engage EPB (Electronic Parking Brake).

- The steering wheel is steered
- The gear is shifted while the vehicle is moving
- Operating EPB while the vehicle is moving
- The hood is open
- The brake pedal or accelerator pedal is depressed when all the doors are closed
- The smart key is outside the vehicle when the brake pedal is depressed while the driver's door is open
- Rapid acceleration occurs
- Vehicle skid occurs
- The wheel is stuck by an obstacle and cannot move
- Approximately 3 minutes and 50 seconds have past after Remote Operation function has started to operate
- The slope of the road exceeds the operational range
- The function is paused for more than 1 minute
- The total travel distance of the vehicle has exceeded 14 m (45 ft.) after Remote Operation function operation
- The steering wheel, gearshift, braking, and drive controls are not working properly
- There is a problem with the smart key or the smart key battery is low
- ABS, TCS or ESC system operates due to slippery road conditions

- The alarm of the Theft Alarm System sounds

## Remote Smart Parking Assist malfunction and limitations

### Remote Smart Parking Assist malfunction

#### Remote Smart Parking Assist check

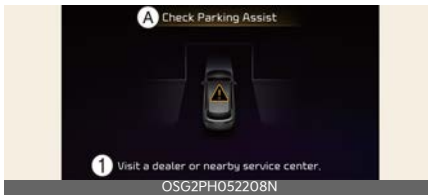

#### A: Check Parking Assist

##### 1 Visit a dealer or nearby service center.

When Remote Smart Parking Assist is not working properly, the warning message will appear on the infotainment system screen. If the message appears, stop using Remote Smart Parking Assist, and have the vehicle inspected by an authorized Kia dealer.

#### Remote Smart Parking Assist canceled



#### A: Parking Assist Canceled.

##### 1 Please refer to the owner's manual.

When Remote Parking Assist is operating, the function can be canceled, and the warning message may appear

regardless of the parking order. Other messages may appear depending on the situations. Follow the instructions provided on the infotainment system screen while parking your vehicle with Remote Parking Assist. Always look around and pay attention when using Remote Smart Parking Assist.

#### Remote Smart Parking Assist standby



#### A: Parking Assist Conditions Not Met

##### 1 Check for Ultrasonic Sensor blockage.

When the message appears, when Parking/View (P) button has been pressed and held, Remote Smart Parking Assist is in standby. After a while, press and hold the Parking/View (P) button again to see if Remote Smart Parking Assist works.

The message appears even when the smart key's battery is low. Check the smart key battery level.

#### Limitations of Remote Smart Parking Assist

In the following circumstances, Remote Smart Parking Assist performance to park or exit the vehicle may be limited, there may be a risk of collision, or Remote Smart Parking Assist may turn off. Park or exit the vehicle manually if necessary.

- An object is attached to the steering wheel

- The vehicle is installed with a snow chain, spare tire or different size wheel
- Tire pressure is lower or higher than the standard tire pressure
- Your vehicle is loaded with cargo longer or wider than your vehicle or a trailer is connected to your vehicle
- There is a problem with the wheel alignment
- Your vehicle is leaned severely to one side
- Your vehicle is equipped with a trailer hitch
- The license plate is installed differently from the original location
- There is a person, animal or object above or below the ultrasonic sensor when Remote Smart Parking Assist is activated
- There is an obstacle such as a person, animal or object (trash can, bicycle, motorcycle, shopping cart, narrow pillar, etc.) near the parking space
- There is a circular pillar or narrow pillar, or a pillar surrounded by objects such as fire extinguisher, etc., near the parking space
- The road surface is bumpy (curbstone, speed bump, etc.)
- The road is slippery
- The parking space is near a vehicle with higher ground clearance or big, such as a truck, etc.
- The parking space is Inclined
- The road surface of parking space with lines is wet due to snow, puddles, or there is a road marker inside the parking space
- There is heavy wind
- Operating Remote Smart Parking Assist on uneven roads, gravel roads, bushes, etc.
- The performance of the ultrasonic sensor is affected by extremely hot or cold weather
- The ultrasonic sensor is covered with snow or water
- An object that generates ultrasonic waves is nearby
- A wireless device with a transmission function operates near the ultrasonic sensors
- Your vehicle is affected by another vehicle's Parking Distance Warning
- The sensor is mounted or positioned incorrectly by an impact to the bumper
- The ultrasonic sensor cannot detect the following objects when:
  - Sharp or slim objects, such as ropes, chains or small poles
  - Objects smaller than 100 cm (40 in.) in length and narrower than 14 cm (6 in.) in diameter
  - Objects which tend to absorb sensor frequency, such as clothes, spongy material or snow
  - A narrow object such as a corner of a square pillar
  - Person, animal or object near the ultrasonic sensor



Remote Smart Parking Assist may not operate properly under the following circumstances:

- Parking on inclines



Park manually when parking on inclines.

- Parking in snow



Snow may interfere with sensor operation, or Remote Smart Parking Assist may cancel if the road is slippery while parking.

- Parking on uneven road



Remote Smart Parking Assist may cancel when the vehicle slips, or the vehicle cannot move due to road conditions such as pebbles or fragmented stones.

- Parking behind a truck



Do not use Remote Smart Parking Assist around vehicles with higher ground clearance, such as a bus, truck, etc. It may lead to an accident.

- Parking near a pillar



Remote Smart Parking Assist performance may reduce or collision with an obstacle may occur when there is a narrow object, circular pillar, square pillar, or a pillar surrounded by objects such as a fire extinguisher, etc., near the parking space. The driver should park the vehicle properly.

- Parking in a parking space with a vehicle on one side only



If Remote Smart Parking Assist is used, when parking in a parking space with a vehicle only on one side, your vehicle may cross the parking line to avoid the parked vehicle.

- Parking diagonal



Remote Smart Parking Assist does not provide diagonal parking. Even if your vehicle was able to enter the parking space, do not use Remote Smart Parking Assist because the function cannot operate properly.

**⚠ WARNING**

- The driver is responsible for safe parking and exit when using Remote Smart Parking Assist.
- When using Remote Smart Parking Assist, stay out of the way in the direction the vehicle moves for your safety.
- Always check surroundings when using Remote Smart Parking Assist. You may collide with pedestrians, animals, or objects if they are near the sensor or are in the sensor's blind spot area.
- A collision may occur if a pedestrian, animal, or object suddenly appears while Remote Smart Parking Assist is operating.
- Do not use Remote Smart Parking Assist when under the influence of alcohol.
- Do not let children or other people to use the smart key.
- If Remote Smart Parking Assist is used continuously for a long period, it may adversely affect Remote Smart Parking Assist performance.
- Remote Smart Parking Assist may not operate properly if the vehicle needs

wheel alignment adjustment such as when the vehicle tilts to one side. Have the vehicle inspected by an authorized Kia dealer.

- Noise may be heard when braking occurs by Remote Smart Parking Assist or when the brake pedal is depressed by the driver.
- Remote Smart Parking Assist may suddenly apply the brake to avoid collision.
- Use Remote Smart Parking Assist only in a parking space that is large enough for the vehicle to move safely.

**\* NOTICE**

- If the 3rd stage warning (continuous beep) of the Forward/Reverse Parking Distance Warning sounds while Remote Smart Parking Assist is operating, it means the obstacle detected is close to your vehicle. At this time, Remote Smart Parking Assist will temporarily stop operating. Make sure there are no pedestrians, animals, or objects around your vehicle.
- Depending on brake operation, the stop lights may come on while the vehicle is moving.
- If the vehicle is remotely started that has been parked in cold weather for a long time, the operation of Remote Smart Parking function may be delayed or canceled depending on vehicle condition.

## Declaration of conformity (if equipped)

### The radio frequency components (Front Radar) complies:

#### For United States and United States territories



OCV051263N

The antenna(s) must be installed such that a minimum separation distance of at least 20 cm is maintained between the radiator (antenna) and all persons at all times. This device must not be co-located or operating in conjunction with any other antenna or transmitter.

ONQ5051134N

#### For Canada

This device complies with Innovation, Science and Economic Development Canada's licence-exempt RSS standard(s). Operation is subject to the following two conditions:

- (1) this device may not cause interference, and
- (2) this device must accept any interference, including interference that may cause undesired operation of the device.

Le présent appareil est conforme aux CNR d'Industrie Canada applicables aux appareils radio exempts de licence. L'exploitation est autorisée

aux deux conditions suivantes:

- (1) l'appareil ne doit pas produire de brouillage, et
- (2) l'utilisateur de l'appareil doit accepter tout brouillage radioélectrique subi, même si le brouillage est susceptible d'en compromettre le fonctionnement.

ONQ5051135N

## The radio frequency components (Rear Corner Radar) complies:

### For United States and United States territories



OCV051263N

FCC ID : LTQH5TR

This device complies with Part 15 of the FCC Rules. Operation is subject to the following two conditions:

- (1) this device may not cause harmful interference, and
- (2) this device must accept any interference received, including interference that may cause undesired operation.

CAUTION TO USERS

Changes or modifications not expressly approved by the party responsible for compliance could void the user's authority to operate the equipment.

ONQ5051136N

#### For Canada

Model: H5TR

IC: 3659A-H5TR

This device complies with Industry Canada licence-exempt RSS standard(s). Operation is subject to the following two conditions:

- (1) this device may not cause interference, and
- (2) this device must accept any interference, including interference that may cause undesired operation of the device.

Le présent appareil est conforme aux CNR d'Industrie Canada applicables aux appareils radio exempts de licence. L'exploitation est autorisée aux deux conditions suivantes:

- (1) l'appareil ne doit pas produire de brouillage, et
- (2) l'utilisateur de l'appareil doit accepter tout brouillage radioélectrique subi, même si le brouillage est susceptible d'en compromettre le fonctionnement.

ONQ5051137N

## Economical operation

Your vehicle's fuel economy depends mainly on your style of driving, where you drive and when you drive.

Each of these factors affects how many kilometers (miles) you can get from a liter (gallon) of fuel. To operate your vehicle as economically as possible, use the following driving suggestions to help save money in both fuel and repairs:

- Drive smoothly. Accelerate at a moderate rate. Don't make "jackrabbit" starts or full-throttle shifts and maintain a steady cruising speed. Don't race between stoplights. Try to adjust your speed to the traffic so you don't have to change speeds unnecessarily. Avoid heavy traffic whenever possible.

Always maintain a safe distance from other vehicles so you can avoid unnecessary braking. This also reduces brake wear.

- Drive at a moderate speed. The faster you drive, the more fuel your vehicle uses. Driving at a moderate speed, especially on the highway, is one of the most effective ways to reduce fuel consumption.
- Take care of your tires. Keep them inflated to the recommended pressure. Incorrect inflation, either too much or too little, results in unnecessary tire wear. Check the tire pressures at least once a month.
- Be sure that the wheels are aligned correctly. Improper alignment can result from hitting curbs or driving too fast over irregular surfaces. Poor alignment causes faster tire wear and may also result in other problems as well as greater fuel consumption.

- Keep your vehicle in good condition. For better fuel economy and reduced maintenance costs, maintain your vehicle in accordance with the maintenance schedule in "Scheduled maintenance service" on page 8-8. If you drive your vehicle in severe conditions, more frequent maintenance is required (Refer to "Scheduled maintenance service" on page 8-8).
- Travel lightly. Don't carry unnecessary weight in your vehicle. Weight reduces fuel economy.
- Don't let the engine idle longer than necessary. If you are waiting (and not in traffic), turn off your engine and restart only when you're ready to go.
- Don't "lug" or "over-rev" the engine. Lugging is driving too slowly in too high a gear resulting in the engine bucking. If this happens, shift to a lower gear. Over-revving is racing the engine beyond its safe limit. This can be avoided by shifting at the recommended speeds.
- Open windows at high speeds can reduce fuel economy.
- Fuel economy is less in crosswinds and headwinds. To help offset some of this loss, slow down when driving in these conditions.

Keeping a vehicle in good operating condition is important both for economy and safety.

Therefore, have the function checked by an authorized Kia dealer.

**⚠ WARNING****Engine off during motion**

Never turn off the vehicle to coast down hills or anytime the vehicle is in motion. The power steering and power brakes will not function properly with turning off the vehicle. In addition, turning off the ignition while driving could engage the steering wheel lock resulting in loss of vehicle steering.

**Special driving conditions**

If driving conditions deteriorate due to poor weather or road conditions, you should pay even more attention than usual to your driving.

**Hazardous driving conditions**

When hazardous driving conditions are encountered such as water, snow, ice, mud, sand, or similar hazards, follow these suggestions:

- Drive cautiously and allow extra distance for braking.
- Avoid sudden braking or steering.
- Do not pump the brake pedal on a vehicle equipped with ABS.
- If stalled in snow, mud, or sand, use the second gear. Accelerate slowly to avoid spinning the drive wheels.
- Use sand, rock salt, or other nonslip material under the drive wheels to provide traction when stalled in ice, snow, or mud.

**Reducing the risk of a rollover**

This multi-purpose passenger vehicle is defined as a Sports Utility Vehicle (SUV). Utility vehicles have a significantly higher rollover rate than other types of vehicles. SUVs have higher ground clearance and a narrower track to make them capable of performing in a wide variety of offroad applications.

Specific design characteristics give them a higher center of gravity than ordinary vehicles. An advantage of the higher ground clearance is a better view of the road, which allows you to anticipate problems.

They are not designed for cornering at the same speeds as conventional passenger vehicles, any more than low-

slung sports vehicles are designed to perform satisfactorily in off-road conditions. Due to this risk, driver and passengers are strongly recommended to buckle their seat belts.

In a rollover crash, an unbelted person is significantly more likely to die than a person wearing a seat belt. There are steps that a driver can make to reduce the risk of a rollover.

If at all possible, avoid sharp turns or abrupt maneuvers, do not load your roof rack with heavy cargo, and never modify your vehicle in any way.

### WARNING

#### Rollover

As with other Sports Utility Vehicle (SUV), failure to operate this vehicle correctly may result in loss of control, an accident or vehicle rollover.

- Utility vehicles have a significantly higher rollover rate than other types of vehicles.
- Specific design characteristics (higher ground clearance, narrower track, etc.) give this vehicle a higher center of gravity than ordinary vehicles.
- A SUV is not designed for cornering at the same speeds as conventional vehicles.
- Avoid sharp turns or abrupt maneuvers.
- In a rollover crash, an unbelted person is significantly more likely to die than a person wearing a seat belt. Make sure everyone in the vehicle is properly buckled up.

### WARNING

Your vehicle is equipped with tires designed to provide safe ride and handling capability. Do not use tires and wheels that are different in size and type from the originally installed ones. It can affect the safety and performance of your vehicle, which could lead to steering failure or rollover and serious injury. When replacing the tires, be sure to equip all four tires with the tire and wheel of the same size, type, tread, brand and load-carrying capacity.

#### Rocking the vehicle

If it is necessary to rock the vehicle to free it from snow, sand, or mud, first turn the steering wheel right and left to clear the area around your front wheels. Then, shift back and forth between R (Reverse) and any forward gear.

Do not race the engine, and spin the wheels as little as possible. If you are still stuck after a few tries, have the vehicle pulled out by a tow vehicle to avoid engine overheating and possible damage to the transmission.

### WARNING

#### Sudden vehicle movement

Do not attempt to rock the vehicle if people or objects are nearby. The vehicle may suddenly move forward or backwards as it becomes unstuck.

### CAUTION

#### Vehicle rocking

Prolonged rocking may cause vehicle overheating, transmission damage or failure, and tire damage.

**⚠ CAUTION****Spinning tires**

Do not spin the wheels, especially at speeds more than 56 km/h (35 mph). Spinning the wheels at high speeds when the vehicle is stationary could overheat and damage tires, and the rotating wheels may fly away and injure bystanders.

**\* NOTICE**

The Electronic Stability Control (ESC) should be turned OFF prior to rocking the vehicle.

**Smooth cornering**

Avoid braking or gear changing in corners, especially when roads are wet. Ideally, corners should always be taken under gentle acceleration. If you follow these suggestions, tire wear will be held to a minimum.

**Driving at night**

Because night driving presents more hazards than driving in the daylight, here are some important tips to remember:

- Slow down and keep more distance between you and other vehicles, as it may be more difficult to see at night, especially in areas where there may not be any street lights.
- Adjust your mirrors to reduce the glare from other driver's headlamps.
- Keep your headlamps clean and properly aimed. (On vehicles not equipped with the automatic headlamp aiming feature.) Dirty or improperly aimed headlamps will make it much more difficult to see at night.
- Avoid staring directly at the headlamps of oncoming vehicles. You could be temporarily blinded, and it will take several seconds for your eyes to readjust to the darkness.

## Driving in the rain



Rain and wet roads can make driving dangerous, especially if you're not prepared for the slick pavement.

Here are a few things to consider when driving in the rain:

- A heavy rainfall will make it harder to see and will increase the distance needed to stop your vehicle, so slow down.
- Keep your windshield wiping equipment in good shape. Replace your windshield wiper blades when they show signs of streaking or missing areas on the windshield.
- If your tires are not in good condition, making a quick stop on wet pavement can cause a skid and possibly lead to an accident. Be sure your tires are in good shape.
- Turn on your headlamps to make it easier for others to see you.
- Driving too fast through large puddles can affect your brakes. If you must go through puddles, try to drive through them slowly.
- If you believe you may have gotten your brakes wet, apply them lightly while driving until normal braking operation returns.

## Hydroplaning

If the road is wet enough and you are going fast enough, your vehicle may have little or no contact with the road surface and actually ride on the water. The best advice is **SLOW DOWN** when the road is wet.

The risk of hydroplaning increases as the depth of tire tread decreases, refer to "Tires and wheels" on page 8-31.

## Driving in flooded areas

Avoid driving through flooded areas unless you are sure the water is no higher than the bottom of the wheel hub. Drive through any water slowly. Allow adequate stopping distance because brake performance may be affected.

After driving through water, dry the brakes by gently applying them several times while the vehicle is moving slowly.

## Highway driving



## Tires

Adjust the tire inflation pressures to specification. Low tire inflation pressures will result in overheating and possible failure of the tires.



Avoid using worn or damaged tires which may result in reduced traction or tire failure.

Never exceed the maximum tire inflation pressure shown on the tires.

### **WARNING**

#### **Under/over inflated tires**

Always check the tires for proper inflation before driving. Under inflated or overinflated tires can cause poor handling, loss of vehicle control, and sudden tire failure, leading to accidents, injuries, and even death. For proper tire pressures, refer to "Tires and wheels" on page 8-31.

### **WARNING**

#### **Tire tread**

Always check the tire tread before driving your vehicle. Worn-out tires can result in loss of vehicle control. Worn-out tires should be replaced as soon as possible. For further information and tread limits, refer to "Tires and wheels" on page 8-31.

## **Fuel, engine coolant and engine oil**

High speed travel consumes more fuel than urban motoring. Do not forget to check both the engine coolant and engine oil.

## **Drive belt**

A loose or damaged drive belt may result in overheating of the engine.

## **Winter driving**

Severe weather conditions in the winter result in greater wear and other problems.

To minimize the problems of winter driving, you should follow these suggestions:

### **Snowy or icy conditions**

To drive your vehicle in deep snow, it may be necessary to use snow tires on your tires.

If snow tires are needed, it is necessary to select tires equivalent in size and type of the original equipment tires. Failure to do so may adversely affect the safety and handling of your vehicle. Furthermore, speeding, rapid acceleration, sudden brake applications, and sharp turns are potentially very hazardous practices. During deceleration, use vehicle braking to the fullest extent. Sudden brake applications on snowy or icy roads may cause skids to occur. You need to keep sufficient distance between the vehicle in operation in front of your vehicle. Also, apply the brake gently.

## Snow tires

If you mount snow tires on your vehicle, make sure they are radial tires of the same size and load range as the original tires. Mount snow tires on all four wheels to balance your vehicle's handling in all weather conditions. Keep in mind that the traction provided by snow tires on dry roads may not be as high as your vehicle's original equipment tires. You should drive cautiously even when the roads are clear. Check with the tire dealer for maximum speed recommendations.

Do not install studded tires without first checking local, state and municipal regulations for possible restrictions against their use.

### **WARNING**

#### Snow tire size

Snow tires should be equivalent in size and type to the vehicle's standard tires. Otherwise, the safety and handling of your vehicle may be adversely affected.

---

## Use high quality ethylene glycol coolant

Your vehicle is delivered with high quality ethylene glycol coolant in the cooling system. It is the only type of coolant that should be used because it helps prevent corrosion in the cooling system, lubricates the water pump and prevents freezing. Be sure to replace or replenish your coolant in accordance with the maintenance schedule in section 8.

Before winter, have your coolant tested to assure that its freezing point is sufficient for the temperatures anticipated during the winter.

## Check battery and cables

Winter puts additional burdens on the battery system. Visually inspect the battery and cables as described in section 8. Have the level of charge in your battery checked by an authorized Kia dealer.

If the vehicle is not used for a long time, park the vehicle indoors if possible.

## Change to "winter weight" oil if necessary

In some climates it is recommended that a lower "winter weight" oil be used during cold weather. See "Recommended SAE viscosity number" on page 9-7. If you aren't sure what weight oil you should use, consult an authorized Kia dealer.

## Check spark plugs and ignition system

Inspect your spark plugs as described in "Scheduled maintenance service" on page 8-8 and replace them if necessary. Also check all ignition wiring and components to be sure they are not cracked, worn or damaged in any way.

## To keep locks from freezing

To keep the locks from freezing, squirt an approved de-icer fluid or glycerine into the key opening. If a lock is covered with ice, squirt it with an approved de-icing fluid to remove the ice. If the lock is frozen internally, you may be able to thaw it out by using a heated key. Handle the heated key with care to avoid injury.

### **Use approved window washer anti-freeze in system**

To keep the water in the window washer system from freezing, add an approved window washer anti-freeze solution in accordance with instructions on the container. Window washer anti-freeze is available from an authorized Kia dealer and most auto parts outlets. Do not use engine coolant or other types of anti-freeze as these may damage the paint finish.

### **Don't let your parking brake freeze**

Under some conditions your parking brake can freeze in the engaged position. This is most likely to happen when there is an accumulation of snow or ice around or near the rear brakes or if the brakes are wet. If there is a risk the parking brake may freeze, temporarily apply it with the gear in P (Park). Also, block the rear wheels in advance, so the vehicle may not roll. Then release the parking brake.

### **Don't let ice and snow accumulate underneath**

Under some conditions, snow and ice can build up under the fenders and interfere with the steering. When driving in severe winter conditions where this may happen, you should periodically check underneath the vehicle to be sure the movement of the front wheels and the steering components is not obstructed.

### **Carry emergency equipment**

Depending on the severity of the weather, you should carry appropriate emergency equipment. Some of the items you may want to carry include tire chains, tow straps or chains, flashlight, emergency flares, sand, shovel, jumper cables, window scraper, gloves, ground cloth, coveralls, blanket, etc.

### **Do not place objects or materials in the engine compartment**

Putting objects or materials in the engine compartment may cause an engine failure or combustion, because they may block the engine cooling. Such damage will not be covered by the manufacturer's warranty.

### **Drive your vehicle when water vapor condenses and accumulates inside the exhaust pipes**

When the vehicle is stopped for a long time in winter while the engine is running, water vapor may condense and accumulate inside the exhaust pipes. Water in the exhaust pipes may cause noise, etc., but it is drained driving at medium to high speed.

### Vehicle load limit

The vehicle load limit is displayed on the tire and loading information label on the driver's door.

### Tire and loading information label

The label located on the driver's side center pillar sill gives the original tire size, cold tire pressures recommended for your vehicle, the number of people that can be in your vehicle and vehicle capacity weight.

Example for spare tire



### Vehicle capacity weight:

- 5 seats: 860 lbs. (390 kg)

Vehicle capacity weight is the maximum combined weight of occupants and cargo. If your vehicle is equipped with a trailer, the combined weight includes the tongue load.

### Seating capacity:

Total: 5 persons (Front seat: 2 persons, Rear seat: 3 persons)

Seating capacity is the maximum number of occupants including a driver, your vehicle may carry.

However, the seating capacity may be reduced based upon the weight of all of the occupants, and the

weight of the cargo being carried or towed.

Do not overload the vehicle as there is a limit to the total weight, or load limit including occupants and cargo, the vehicle can carry.

### Towing capacity:

We do not recommend using this vehicle for trailer towing.

### Cargo capacity:

The cargo capacity of your vehicle will increase or decrease depending on the weight and the number of occupants.

### Steps For Determining Correct Load Limit-

1. Locate the statement "The combined weight of occupants and cargo should never exceed XXX kg or XXX lbs." on your vehicle's placard.
2. Determine the combined weight of the driver and passengers that will be riding in your vehicle.
3. Subtract the combined weight of the driver and passengers from XXX kg or XXX lbs.

4. The resulting figure equals the available amount of cargo and luggage load capacity. For example, if the "XXX" amount equals 635 kg (1400 lbs.) and there will be five 68 kg (150 lbs.) passengers in your vehicle, the amount of available cargo and luggage load capacity is 295 kg (650 lbs.).  $(635 - 340 (5 \times 68)) = 295$  kg or  $1400 - 750 (5 \times 150) = 650$  lbs.)
5. Determine the combined weight of luggage and cargo being loaded on the vehicle. That weight may not safely exceed the available cargo and luggage load capacity calculated in Step 4.
6. If your vehicle will be towing a trailer, load from your trailer will be transferred to your vehicle. Consult this manual to determine how this reduces the available cargo and luggage load capacity of your vehicle.

**⚠ WARNING**

**Loose cargo**

Do not travel with unsecured blunt objects in the passenger compartment of your vehicle (e.g., suit cases or unsecured child seats). These items may strike an occupant during a sudden stop or crash.

Example 1



Item	Description	Total
A	Vehicle Capacity Weight	390 kg (860 lbs.)
B	Subtract Occupant Weight 68 kg (150 lbs.)x2	136 kg (300 lbs.)
C	Available Cargo and Luggage weight	249 kg (549 lbs.)

Example 2

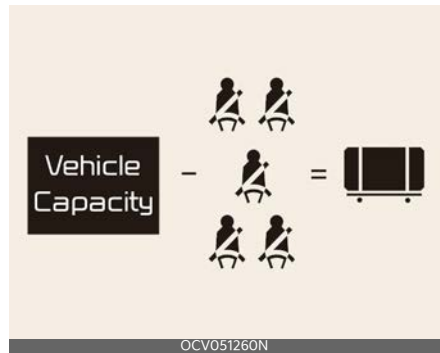

Item	Description	Total
A	Vehicle Capacity Weight	390 kg (860 lbs.)
B	Subtract Occupant Weight 150 lbs. (68 kg)x5	340 kg (750 lbs.)
C	Available Cargo and Luggage weight	45 kg (99 lbs.)

Example 3

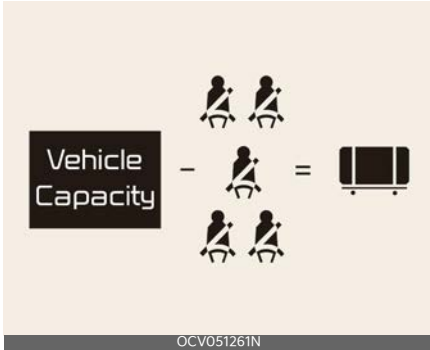

Item	Description	Total
A	Vehicle Capacity Weight	390 kg (860 lbs.)
B	Subtract Occupant Weight 161 lbs. (73 kg)×5	365 kg (805 lbs.)
C	Available Cargo and Luggage weight	20 kg (44 lbs.)

Refer to your vehicle's tire and loading information label for specific information about your vehicle's capacity weight and seating positions. The combined weight of the driver, passengers and cargo should never exceed your vehicle's capacity weight.

**Certification label**

The certification label is located on the driver's door sill at the center pillar.



This label shows the maximum allowable weight of the fully loaded vehicle. This is called the GVWR (Gross Vehicle Weight Rating). The GVWR includes the weight of the vehicle, all occupants and cargo.

This label also tells you the maximum weight that can be supported by the front and rear axles, called Gross Axle Weight Rating (GAWR).

To find out the actual loads on your front and rear axles, you need to go to a weigh station and weigh your vehicle. Your dealer can help you with this. Be sure to spread out your load equally on both sides of the centerline.

**⚠ WARNING**

**Over loading**

Never exceed the GVWR for your vehicle, the GAWR for either the front or rear axle and vehicle capacity weight. Exceeding these ratings can affect your vehicle's handling and braking ability.

The label will help you decide how much cargo and installed equipment your vehicle can carry.

If you carry items inside your vehicle - like suitcases, tools, packages, or anything else - they are moving as fast as the vehicle. If you have to stop or turn quickly, or if there is a crash, the items will keep going and can cause an injury if they strike the driver or a passenger.

### **▲ WARNING**

#### **Over loading**

Do not overload your vehicle. Overloading your vehicle can cause heat buildup in your vehicle's tires and possible tire failure, increased stopping distances and poor vehicle handling--all of which may result in a crash.

### **\* NOTICE**

Overloading your vehicle may cause damage. Repairs would not be covered by your warranty. Do not overload your vehicle.

## **Vehicle weight**

This section will guide you in the proper loading of your vehicle, to keep your loaded vehicle weight within its design rating capability. Properly loading your vehicle will provide maximum return of the vehicle design performance. Before loading your vehicle, familiarize yourself with the following terms for determining your vehicle's weight ratings, from the vehicle's specifications and the certification label:

### **Base curb weight**

This is the weight of the vehicle including a full tank of fuel and all standard equipment. It does not include passengers, cargo, or optional equipment.

### **Vehicle curb weight**

This is the weight of your new vehicle when you picked it up from your dealer plus any aftermarket equipment.

### **Cargo weight**

This figure includes all weight added to the Base Curb Weight, including cargo and optional equipment.

### **GAW (Gross axle weight)**

This is the total weight placed on each axle (front and rear) - including vehicle curb weight and all payload.

**GAWR (Gross axle weight rating)**

This is the maximum allowable weight that can be carried by a single axle (front or rear). These numbers are shown on the certification label.

The total load on each axle must never exceed its GAWR.

**GVW (Gross vehicle weight)**

This is the Base Curb Weight plus actual Cargo Weight plus passengers.

**GVWR (Gross vehicle weight rating)**

This is the maximum allowable weight of the fully loaded vehicle (including all options, equipment, passengers and cargo). The GVWR is shown on the certification label located on the driver's (or front passenger's) door sill.

**Overloading****⚠ WARNING**

The Gross Axle Weight Rating (GAWR) and the Gross Vehicle Weight Rating (GVWR) for your vehicle are on the Certification Label attached to the driver's (or front passenger's) door. Exceeding these ratings can cause an accident or vehicle damage. You can calculate the weight of your load by weighing the items (and people) before putting them in the vehicle. Be careful not to overload your vehicle.

---



# What to do in an emergency

<b>Road warning</b> .....	<b>7-3</b>
• Hazard warning flasher.....	7-3
<b>In case of an emergency while driving</b> .....	<b>7-3</b>
• If the vehicle stalls while driving.....	7-3
• If the engine stalls at a crossroad or crossing.....	7-3
• If you have a flat tire while driving.....	7-3
<b>If the engine will not start</b> .....	<b>7-4</b>
• If engine doesn't turn over or turns over slowly.....	7-4
• If engine turns over normally but does not start.....	7-4
<b>Emergency starting</b> .....	<b>7-5</b>
• Before jump starting (for hybrid vehicle).....	7-5
• Jump starting.....	7-6
<b>If the engine overheats</b> .....	<b>7-7</b>
<b>Tire Pressure Monitoring System (TPMS)</b> .....	<b>7-9</b>
• Effective use of TPMS.....	7-9
• Low tire pressure telltale.....	7-10
• Tire Pressure Monitoring System (TPMS) malfunction indicator.....	7-11
• Tire replacement with TPMS.....	7-12
• This device complies with Industry Canada licence-exempt RSS standard(s).....	7-13
<b>If you have a flat tire (with spare tire)</b> .....	<b>7-13</b>
• Jack and tools.....	7-14
• Removing and storing the spare tire.....	7-15
• Changing tires.....	7-15
• Important - use of compact spare tire.....	7-18
• Jack label.....	7-20
<b>If you have a flat tire (with tire mobility kit)</b> .....	<b>7-21</b>
• Introduction.....	7-21
• Components of the Tire Mobility Kit.....	7-22

# 7 What to do in an emergency

- Using the Tire Mobility Kit ..... 7-23
- Distributing the sealant ..... 7-24
- Checking the tire inflation pressure ..... 7-25
- Towing.....7-26**
- Towing without wheel dollies when using a towing service ..... 7-28

## What to do in an emergency

### Road warning

When an emergency situation occurs while driving or when you park by the edge of the roadway, you must alert approaching or passing vehicles to be careful as they pass. For this, you should use the hazard warning flasher.

### Hazard warning flasher

The hazard warning flasher serves as a warning to other drivers to exercise extreme caution when approaching, overtaking, or passing your vehicle.



It should be used whenever emergency repairs are being made or when the vehicle is stopped near the edge of a roadway.

Depress the flasher switch with the ENGINE START/STOP button in any position. The flasher switch is located in the center fascia panel. All turn signal lights will flash simultaneously.

- The hazard warning flasher operates whether your vehicle is running or not.
- The turn signals do not work when the hazard flasher is on.
- Care must be taken when using the hazard warning flasher while the vehicle is being towed.

## In case of an emergency while driving

If an emergency situation occurs while driving, stay calm and take the following steps.

### If the vehicle stalls while driving

1. Reduce your speed gradually, keeping a straight line.
2. Move cautiously off the road to a safe place.
3. Turn on your hazard warning flasher.
4. Try to start the vehicle again. If your vehicle will not start, contact an authorized Kia dealer or seek other qualified assistance.

### If the engine stalls at a crossroad or crossing

- If the engine stalls at a crossroad or crossing, set the shifter dial in the N (Neutral) position and then push the vehicle to a safe place.

### If you have a flat tire while driving

1. Take your foot off the accelerator pedal and let the vehicle slow down while driving straight ahead. Do not apply the brakes immediately or attempt to pull off the road as this may cause a loss of control.
2. When the vehicle has slowed to such a speed that it is safe to do so, brake carefully and pull off the road.
3. Drive off the road as far as possible and park on firm level ground. If you are on a divided highway, do not park in the median area between the two traffic lanes.

4. When the vehicle is stopped, turn on your emergency hazard flashers, set the parking brake and put the transmission in P.
5. Have all passengers get out of the vehicle. Be sure they all get out on the side of the vehicle that is away from traffic.
6. When changing a flat tire, follow the instruction provided later in this section.

### \* NOTICE

If there was a check engine light and loss of power or stall and if safe to do so, wait at least 10 seconds to restart the vehicle after it stalls. This may reset the car so it will no longer run at low power (limp home) condition.

## If the engine will not start

When the engine doesn't start, first check to see how much fuel there is and whether the battery is discharged.

### If engine doesn't turn over or turns over slowly

1. Be sure the shifter dial is in N (Neutral) or P (Park) and the emergency brake is set.
2. Check the battery connections to be sure they are clean and tight.
3. Turn on the interior light. If the light dims or goes out when you operate the starter, the battery is discharged.
4. Check the starter connections to be sure they are securely tightened.

### ⚠ WARNING

Do not push or pull the vehicle to start it. This could cause damage to your vehicle. Refer to "Emergency starting" on page 7-5.

### If engine turns over normally but does not start

1. Check the fuel level and add fuel if necessary.
2. With the ENGINE START/STOP button in the OFF position, check all connectors at the ignition coils and spark plugs. Reconnect any that may be disconnected or loose.
3. Check the fuel line in the engine compartment.
4. If the engine still does not start, call an authorized Kia dealer or seek other qualified assistance.

## Emergency starting

### Before jump starting (for hybrid vehicle)

This vehicle does not have a regular 12V battery that needs periodic replacement. It is lithium ion polymer type integrated into the HEV high voltage battery. The vehicle has a 12V battery protection system that cuts 12V battery from vehicle draw to prevent full discharge.

### Using the 12V battery reset button



1. Press the 12V Battery Reset button to reconnect the 12V battery.
2. Start the vehicle within 15 seconds of pressing the 12V Battery Reset button.
3. After starting the vehicle (READY indicator on), operate the vehicle safely outdoors in ready mode stopped and/or drive it for 30 minutes total to charge the 12V battery fully.

If you do not start the vehicle immediately after pressing the 12V Battery Reset button, the power of 12V battery is automatically disconnected after few seconds to save the 12V battery from additional discharge. If the 12V battery is disconnected prior to starting the vehicle, press the 12V Battery Reset button again and then immediately start the vehicle as explained.

Repeated use of the 12V Battery Reset button without a sufficient vehicle ON cycle (30 Min+) may cause over discharge of the 12V battery, which will pre-

vent the vehicle from starting. If the 12V battery is over discharged to a point that the reset does not work, try to jumpstart the vehicle.

#### \* NOTICE

After starting the vehicle (READY indicator on), the 12V battery is being charged whether the engine is running or not. Although there is no engine sound, it is unnecessary to depress the accelerator pedal.

The following items may need to be reset after the battery has been discharged or the battery has been disconnected.

See chapter 4 and 5 for:

- Power Windows
- Trip Computer
- Climate Control System
- Audio System
- Sunroof

#### \* NOTICE

### External power source using 12V battery

The use of external power accessories may reduce performance and function of the vehicle. Especially, the use of dash cameras may shut off the power of the vehicle prior to the dash camera's automatic shut-down.

If the power of the vehicle is shut off, start the vehicle as explained.

## Jump starting

In the event vehicle still does not have a functional 12V battery (check if interior lights do not turn on) then you can try a jump start to the engine compartment jumper terminals using a 12V booster pack or jumper cables from another vehicle's 12V battery according to the following instructions.

### ⚠ CAUTION

Jump starting can be dangerous if done incorrectly. Follow the jump starting procedure in this section to avoid serious injury or damage to your vehicle. If in doubt about how to properly jump start your vehicle, we strongly recommend that you have a service technician or towing service do it for you.

1. Position the vehicles close enough that the jumper cables will reach, but do not allow the vehicles to touch. Avoid fans or any moving parts in the engine compartment at all times, even when the vehicles are turned off.
2. Turn off all electrical devices such as radios, lights, air conditioning, etc. Put the vehicles in P (Park) and set the parking brake. Turn both vehicles OFF.
3. Connect the jumper cables in the exact sequence shown in the illustration. First, connect one jumper cable to the charging terminal inside the engine compartment fuse panel (1).

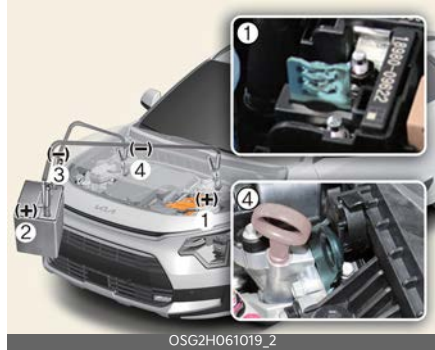

4. Connect the other end of the jumper cable to the red, positive (+) battery/jumper terminal of the assisting vehicle (2).
5. Connect the second jumper cable to the black, negative (-) battery/chassis ground of the assisting vehicle (3).
6. Connect the other end of the second jumper cable to a solid, stationary, metallic point away from the battery (4).

Do not allow the jumper cables to contact anything except the correct battery or jumper terminals or the correct ground. Do not lean over the battery when making connections.

7. For hybrid vehicle, press the 12V Battery Reset button.



8. Start the engine of the assisting vehicle and let it run for a few minutes.
9. Start your vehicle as soon as possible. After starting the vehicle (READY indicator on), operate the vehicle safely outdoors in ready mode stopped and/

or drive it for 30 minutes total to charge the 12V battery fully.

If your vehicle will not start after a few attempts, it probably requires servicing. In this event please seek qualified assistance. If the cause of your battery discharging is not apparent, we recommend that you have your vehicle checked by an authorized Kia dealer.

Disconnect the jumper cables in the exact reverse order you connected them:

1. Disconnect the jumper cable from the black, negative (-) chassis ground of your vehicle (4).
2. Disconnect the other end of the jumper cable from the black, negative (-) battery/chassis ground of the assisting vehicle (3).
3. Disconnect the second jumper cable from the red, positive (+) battery/jumper terminal of the assisting vehicle (2).
4. Disconnect the other end of the jumper cable from the red, positive (+) jumper terminal of your vehicle (1).

**\* NOTICE**

The voltage range of the charger should be 13.3~14V and its current range should be less than 60A. (13.8V is recommended).

**⚠ CAUTION**

- The use of an improper charger with a voltage and current range higher than specified may cause overheating and damage to the 12V battery.
- The use of an incorrect charger will lead to a power shut-off to save the 12V battery. Stop using the incorrect

charger once the power of the vehicle is shut off.

**\* NOTICE**



An inappropriately disposed battery can be harmful to the environment and human health. Dispose the battery according to your local law(s) or regulation.

**\* NOTICE**

To prevent damage to your vehicle:

- Only use a 12-volt power supply (battery or jumper system) to jump start your vehicle.
- Do not attempt to jump start your vehicle by push-starting.

**Push-starting**

Vehicles equipped with dual clutch transmission cannot be push-started, and only jump-starting can be applied. Refer to "Emergency starting" on page 7-5.

**⚠ WARNING**

**Tow starting vehicle**

Never tow a vehicle to start it. When the engine starts, the vehicle can suddenly surge forward and could cause a collision with the tow vehicle.

**If the engine overheats**

If your temperature gauge indicates overheating, you experience a loss of power, or hear a loud pinging or knocking, the engine will probably be too hot.

If this happens, you should:

1. Pull off the road and stop as soon as it is safe to do so.

2. Shift the gear to P (Park) and set the parking brake.
3. If the air conditioning is on, turn it off.
4. If engine coolant is running out under the vehicle or steam is coming out from underneath the hood, stop the engine. Do not open the hood until the coolant has stopped running or the steaming has stopped.
5. If there is no visible loss of engine coolant and no steam, leave the engine running and check to be sure the engine cooling fan is operating.
  - 1) If the fan is not running, turn the engine off.
6. Check to see if the water pump drive belt is missing.
  - 1) If it is not missing, check to see that it is tight.
  - 2) If the drive belt seems to be satisfactory, check for coolant leaking from the radiator, hoses or under the vehicle. (If the air conditioning had been in use, it is normal for cold water to be draining from it when you stop).

**⚠ WARNING**

**Under the hood**



While the engine is running, keep hair, hands and clothing away from moving parts, such as the fan and drive belts, to prevent injury.

7. If the water pump drive belt is broken or engine coolant is leaking out, stop the engine immediately and call the nearest a professional workshop for assistance. Call an authorized Kia dealer.
8. If you cannot find the cause of the overheating, wait until the engine

temperature has returned to normal. If coolant has been lost, carefully add coolant to the reservoir to bring the fluid level in the reservoir up to the halfway mark.

9. Proceed with caution, keeping alert for further signs of overheating. If overheating happens again, call a professional workshop for assistance. Call an authorized Kia dealer.

**⚠ WARNING**

**Coolant reservoir cap**



Do not remove the engine coolant reservoir cap when the engine is hot. This may result in coolant being blown out of the opening and cause serious burns.

If the inverter coolant is running out, call the nearest a professional workshop for assistance. Have the vehicle inspected by an authorized Kia dealer.

Use of other coolant type or water may damage the inverter.

**⚠ CAUTION**

- Serious loss of coolant indicates there is a leak in the cooling system and this should be checked as soon as possible. Have your vehicle checked by an authorized Kia dealer.
- When the engine overheats from low engine coolant, suddenly adding engine coolant may cause cracks in the engine. To prevent damage, add engine coolant slowly in small quantities.



## Tire Pressure Monitoring System (TPMS)

The Tire Pressure Monitoring System (TPMS) detects the pressure of vehicle's tires and displays it on the LCD display.



- 1 Low tire pressure telltale/TPMS malfunction indicator
- 2 Low tire pressure position telltale (Shown on the LCD display)

### Tire Pressure Indicator

- You can check the tire pressure in the assist mode on the cluster.
  - Refer to "Driving Assist mode" on page 5-84.
- Tire pressure is displayed 1 ~ 2 minutes later after driving.
- If tire pressure is not displayed when the vehicle is stopped, "Drive to display" message displays. After driving, check the tire pressure.
- You can change the tire pressure unit in the user settings mode on the cluster.
  - psi, kPa, bar (Refer to "User settings mode" on page 5-85).

### \* NOTICE

- The tire pressure may change due to factors such as parking condition, driving style, and altitude above sea level.
- The tire pressure shown on the dashboard may differ from the tire pressure measured by tire pressure gauge.
- Low tire pressure warning may sound when a tire's pressure unit is equal or lower than nearby tires. This is a normal occurrence, which is due to the change in tire pressure along with tire temperature.

### Effective use of TPMS

#### ⚠ WARNING

Over-inflation or under-inflation can reduce tire life, adversely affect vehicle handling, and lead to sudden tire failure that may cause loss of vehicle control resulting in an accident.

Each tire, including the spare (if provided), should be checked monthly when cold and inflated to the inflation pressure recommended by the vehicle manufacturer on the vehicle placard or tire inflation pressure label.

(If your vehicle has tires of a different size than the size indicated on the vehicle placard or tire inflation pressure label, you should determine the proper tire inflation pressure for those tires.)

As an added safety feature, your vehicle has been equipped with a tire pressure monitoring system (TPMS) that illuminates a low tire pressure telltale when one or more of your tires is significantly under-inflated. Accordingly, when the low tire pressure telltale illuminates, you

should stop and check your tires as soon as possible, and inflate them to the proper pressure. Driving on a significantly under-inflated tire causes the tire to overheat and can lead to tire failure. Under-inflation also reduces fuel efficiency and tire tread life, and may affect the vehicle's handling and stopping ability.

Please note that the TPMS is not a substitute for proper tire maintenance, and it is the driver's responsibility to maintain correct tire pressure, even if under-inflation has not reached the level to trigger illumination of the TPMS low tire pressure telltale.

Your vehicle has also been equipped with a TPMS malfunction indicator to indicate when the system is not operating properly. The TPMS malfunction indicator is combined with the low tire pressure telltale. When the system detects a malfunction, the telltale will flash for approximately one minute and then remain continuously illuminated. This sequence will continue upon subsequent vehicle start-ups as long as the malfunction exists. When the malfunction indicator is illuminated, the system may not be able to detect or signal low tire pressure as intended. TPMS malfunctions may occur for a variety of reasons, including the installation of replacement or alternate tires or wheels on the vehicle that prevent the TPMS from functioning properly.

Always check the TPMS malfunction telltale after replacing one or more tires or wheels on your vehicle to ensure that the replacement or alternate tires and wheels allow the TPMS to continue to function properly.

**\* NOTICE**

If any of the below happens, have the system checked by an authorized Kia dealer.

1. The low tire pressure telltale/TPMS malfunction indicator does not appear for 3 seconds when the ENGINE START/STOP button is turned to the ON position or engine is running.
2. The TPMS malfunction indicator remains illuminated after blinking for approximately 1 minute.
3. The Low tire pressure position telltale remains illuminated.

**Low tire pressure telltale (⚠)**

**Low tire pressure position telltale**

When the TPMS warning indicators appear, one or more of your tires is significantly under-inflated.



**A: Low tire pressure**

If the telltale appears, immediately reduce your speed, avoid hard cornering and anticipate increased stopping distances. You should stop and check your tires as soon as possible.

Inflate the tires to the proper pressure as indicated on the vehicle's placard or tire inflation pressure label located on the driver's side center pillar outer panel. If you cannot reach a service station or if the tire cannot hold the newly added air, replace the low pressure tire with the spare tire.

Then the TPMS malfunction indicator and the Low Tire Pressure telltale may turn on and appear after restarting and about 20 minutes of continuous driving before you have the low pressure tire repaired and replaced on the vehicle.

In winter or cold weather, the low tire pressure telltale may appear if the tire pressure was adjusted to the recommended tire inflation pressure in warm weather. It does not mean your TPMS is malfunctioning because the decreased temperature leads to a proportional lowering of tire pressure.

You should check the tire inflation pressure and adjust the tires to the recommended tire inflation pressure when driving your vehicle in the following conditions.

- from a warm area to a cold area
- from a cold area to a warm area
- the outside temperature is extremely high or low

When filling tires with more air, conditions to turn off the low tire pressure telltale may not be met. This is because a tire inflator has a margin of error in performance. The low tire pressure telltale will be turned off if the tire pressure is above the recommended tire inflation pressure.

### **WARNING**

#### **Low pressure damage**

Do not drive on low pressure tires. Significantly low tire pressure can cause the tires to overheat and fail, making the vehicle unstable, resulting in increased braking distances and a loss of vehicle control.

## **Tire Pressure Monitoring System (TPMS) malfunction indicator**

The low tire pressure telltale will appear after it blinks for approximately one minute when there is a problem with the TPMS.

If the system is able to correctly detect an underinflation warning at the same time as system failure, it will appear both the TPMS malfunction and the low tire pressure position telltales. For example, if the Front Left sensor fails, the TPMS malfunction indicator appears, but if the Front Right, Rear Left, or Rear Right tire is underinflated, the low tire pressure position telltales may appear together with the TPMS malfunction indicator.

Have the system checked by an authorized Kia dealer as soon as possible to determine the cause of the problem.

- The TPMS malfunction indicator may appear if the vehicle is moving around electric power supply cables or radios transmitters such as at police stations, government and public offices, broadcasting stations, military installations, airports, or transmitting towers, etc. This can interfere with normal operation of the TPMS.
- The TPMS malfunction indicator may appear if the vehicle is equipped with snow chains or some personal electronic devices (such as a laptop computer, mobile charger, remote starter or navigation) are being used in the vehicle. This can interfere with normal operation of the TPMS.

## Tire replacement with TPMS

If you have a flat tire, the Low Tire Pressure telltale will come on. Have the flat tire repaired by an authorized Kia dealer as soon as possible or replace the flat tire with the spare tire.

### CAUTION

#### Repair Agents

Never use a puncture-repairing agent not approved by Kia to repair and/or inflate a low pressure tire. Sealant that is not approved by Kia may damage the tire pressure sensor.

Each wheel is equipped with a tire pressure sensor mounted inside the tire behind the valve stem. You must use TPMS specific wheels. Always have your tires serviced by an authorized Kia dealer.

Even if you replace the low pressure tire with the spare tire, the Low Tire Pressure telltale will remain on until the low pressure tire is repaired and placed on the vehicle.

After you replace the low pressure tire with the spare tire, the TPMS malfunction indicator may appear after a few minutes. This is because the TPMS sensor mounted on the spare wheel is not yet activated.

Once the low pressure tire is inflated again to the recommended pressure and installed on the vehicle or the TPMS sensor mounted on the replaced spare wheel is initiated by a professional workshop, the TPMS malfunction indicator and the low tire pressure telltale will turn off within a few minutes of driving.

If the indicator has not disappeared after a few minutes of driving, please visit an authorized Kia dealer.

If an original mounted tire is replaced with the spare tire, the TPMS sensor on the replaced spare wheel should be initiated and the TPMS sensor on the original mounted wheel should be deactivated. If the TPMS sensor on the original mounted wheel located in the spare tire carrier still activates, the Tire Pressure Monitoring System may not operate properly. Have the tire with TPMS serviced or replaced by an authorized Kia dealer.

You may not be able to identify a low tire by simply looking at it. Always use a good quality tire pressure gauge to measure the tire's inflation pressure. Please note that a tire that is hot (from being driven) will have a higher pressure measurement than a tire that is cold (from sitting stationary for at least 3 hours and driven less than 1.6 km (1 mile) during that 3 hour period).

Allow the tire to cool before measuring the inflation pressure. Always be sure the tire is cold before inflating to the recommended pressure.

A cold tire means the vehicle has been sitting for 3 hours and driven for less than 1.6 km (1 mile) in that 3 hour period.

Never use tire sealant if your vehicle is equipped with a TPMS. The liquid sealant can damage the tire pressure sensors.

- The TPMS cannot alert you to severe and sudden tire damage caused by external factors such as nails or road debris.
- If you feel any vehicle instability, immediately take your foot off the accelerator, apply the brakes gradually and with light force, and slowly move to a safe position off the road.

**\* NOTICE****Protecting TPMS**

Tampering with, modifying, or disabling the Tire Pressure Monitoring System (TPMS) components may interfere with the system's ability to warn the driver of low tire pressure conditions and/or TPMS malfunctions. Tampering with, modifying, or disabling the Tire Pressure Monitoring System (TPMS) components may void the warranty for that portion of the vehicle.

**This device complies with Industry Canada licence-exempt RSS standard(s).**

Operation is subject to the following conditions:

1. This device may not cause interference, and
2. This device must accept any interference, including interference that may cause undesired operation of the device.
3. Changes or modifications not expressly approved by the party responsible for compliance could void the user's authority to operate the device.

**If you have a flat tire (with spare tire) (if equipped)**

If you have a flat tire, you can change the flat tire to a spare tire using tools.

**⚠ WARNING**

Driving on a flat tire will cause permanent damage to the tire. Re-inflating a tire after it has been driven on while severely underinflated or flat may cause a blowout and a serious crash. Never attempt to re-inflate a tire that has been driven on while severely underinflated or flat. In this case, repair or replace the flat tire as soon as possible.

**⚠ WARNING**

Changing a tire can be dangerous. Follow the instructions in this section when changing a tire to reduce the risk of serious injury or death.

**⚠ CAUTION**

Be careful as you use the jack handle to stay clear of the flat end. The flat end has sharp edges that could cause cuts.

### Jack and tools



The jack, jack handle, wheel lug nut wrench are stored in the luggage compartment.

Pull up the luggage box cover to reach this equipment.

- 1 Jack handle
- 2 Jack
- 3 Wheel lug nut wrench

### Jacking instructions

The jack is provided for emergency tire changing only.

- To prevent the jack from "rattling" while the vehicle is in motion, store it properly.
- Follow jacking instructions to reduce the possibility of personal injury.

#### ⚠ WARNING

### Changing tires

- Never attempt vehicle repairs in the traffic lanes of a public road or highway.
- Always move the vehicle completely off the road and onto the shoulder before trying to change a tire. The jack should be used on firm level ground. If you cannot find a firm level place off the road, call a towing service company for assistance.
- Be sure to use the correct front and rear jacking positions on the vehicle; never use the bumpers or any other part of the vehicle for jacking support.

- The vehicle can roll off the jack causing serious injury or death.
- Do not go under a vehicle that is supported by a jack.
- Do not start or run the engine while the vehicle is on the jack.
- Do not allow anyone to remain in the vehicle while it is on the jack.
- Make sure any children present are in a secure place, away from the road and from the vehicle to be raised with the jack.

#### ⚠ WARNING

### Tire jack

Do not place any portion of your body under a vehicle that is only supported by a jack since the vehicle can easily roll off the jack. Use vehicle support stands.

#### ⚠ WARNING

### Changing tires

Never attempt vehicle repairs in the traffic lanes of a public road or highway.

#### ⚠ WARNING

### Running vehicle on jack

Do not start or run the engine of the vehicle while the vehicle is on the jack as this may cause the vehicle to fall off the jack.

To prevent the jack from "rattling" while the vehicle is in motion, store it properly.

**\* NOTICE**

**Retreaded tires**

Substantial design variations and the age of the retreaded tire casing structure can limit service life and have negative impact on road safety.

**Removing and storing the spare tire**



Your spare tire is stored in the cargo area.

- Turn the tire hold-down wing bolt counterclockwise to remove.
- Store the tire in the reverse order of removal.
- To prevent the spare tire and tools from "rattling" while the vehicle is in motion, store them properly.

**⚠ WARNING**

**Touching surface of the luggage room floor**

Do not touch the metal surface of the luggage room floor while the engine is operating or hot. Doing so could result in serious bodily injury.

Turn the engine off and wait until it cools down or wear gloves to remove the spare tire from the luggage room.

If it is hard to loosen the tire holddown wing bolt by hand, you can loosen it easily using the jack handle.



- Put the jack inside of the tire hold-down wing bolt.
- Turn the tire hold-down wing bolt counterclockwise with the jack handle. Use caution when utilizing the sharp jack handle.

**Changing tires**

**⚠ WARNING**

A vehicle can slip or roll off of a jack causing serious injury or death to you or those nearby. Take the following safety precautions:

- Never place any portion of your body under a vehicle that is supported by a jack.
- NEVER attempt to change a tire in the lane of traffic. ALWAYS move the vehicle completely off the road on level, firm ground away from traffic before trying to change a tire. If you cannot find a level, firm place off the road, call a towing service for assistance.
- Be sure to use the jack provided with the vehicle.
- ALWAYS place the jack on the designated jacking positions on the vehicle and NEVER on the bumpers or any other part of the vehicle for jacking support.
- Do not start or run the engine while the vehicle is on the jack.

- Do not allow anyone to remain in the vehicle while it is on the jack.
- Keep children away from the road and the vehicle.

1. Park on a level surface and apply the parking brake firmly.



2. Shift the gear to P (Park), apply the parking brake, and turn the engine OFF.
3. Activate the hazard warning flasher.
4. Remove the wheel lug nut wrench, jack, jack handle, and spare tire from the vehicle.
5. Block both the front and rear of wheel that is diagonally opposite the jack position.



**WARNING**

**Jack location**

To reduce the possibility of injury, be sure to only use the jack provided with the vehicle in the correct jack position; never use any other part of the vehicle for jack support.

**WARNING**

**Changing a tire**

- To prevent vehicle movement while changing a tire, always set the parking brake fully, and always block the wheel diagonally, opposite the wheel being changed.
- We recommend that the wheels of the vehicle be blocked, and that no person remain in a vehicle that is being jacked.

6. Loosen the wheel lug nuts counter-clockwise one turn each, but do not remove any nut until the tire has been raised off the ground.



7. Place the jack at the front (1) or rear (2) jacking position closest to the tire you are changing. Place the jack at the designated locations under the frame. The jacking positions are plates welded to the frame with two tabs and a raised dot to index with the jack.

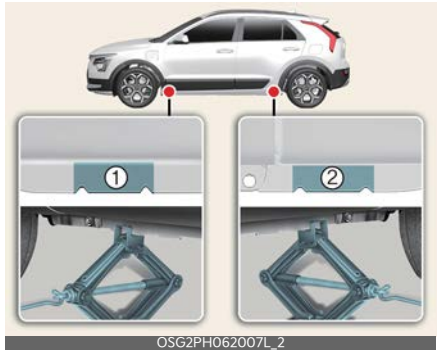



- Insert the jack handle into the jack and turn it clockwise, raising the vehicle until the tire just clears the ground. This measurement is approximately 30 mm (1.2 inches). Before removing the wheel lug nuts, make sure the vehicle is stable and that there is no chance for movement or slippage.



- Loosen the wheel nuts and remove them with your fingers. Slide the wheel off the studs and lay it flat so it cannot roll away. To put the wheel on the hub, pick up the spare tire, line up the holes with the studs and slide the wheel onto them.

If this is difficult, tip the wheel slightly and get the top hole in the wheel lined up with the top stud. Then jiggle the wheel back and forth until the wheel can be slid over the other studs.

- To reinstall the wheel, hold it on the studs, put the wheel nuts on the studs and tighten them finger tight. Jiggle the tire to be sure it is completely seated, then tighten the nuts as much as possible with your fingers again.
- Lower the vehicle to the ground by turning the wheel nut wrench counterclockwise.



Then position the wrench as shown in the drawing and tighten the wheel nuts. Be sure the socket is seated completely over the nut. Do not stand on the wrench handle or use an extension pipe over the wrench handle. Go around the wheel tightening every other nut until they are all tight. Then double-check each nut for tightness. After changing wheels, have the system checked by an authorized Kia dealer.

### **⚠ WARNING**

#### **Installing a wheel**

- When you install a wheel, always remove any corrosion, dirt or foreign materials present on the mounting surfaces of the wheel or the surface of the wheel hub, brake drum or brake disc that contacts the wheel. Make sure to secure any fasteners that attach the rotor to the hub so they do not interfere with the mounting surfaces of the wheel. Installing wheels without correct metal-to-metal contact at the wheel mounting surfaces can cause the wheel nuts to loosen and the wheel to come off while your vehicle is in motion, resulting in loss of vehicle control, personal injury or death.
- Make sure the wheel makes good contact with the hub when installed. If the contact of the mounting surface between the wheel and hub is not good, the wheel nuts could come loose and cause the loss of a wheel. Loss of a wheel may result in loss of control of the vehicle.

**Wheel nut tightening torque:**

Steel wheel & aluminum alloy wheel:  
11 ~ 13 kgf·m (79 ~ 94 lbf·ft)

If you have a tire gauge, remove the valve cap and check the air pressure. If the pressure is lower than recommended, drive slowly to the nearest service station and inflate to the correct pressure. If it is too high, adjust it until it is correct. Always reinstall the valve cap after checking or adjusting tire pressure. If the cap is not replaced, air may leak from the tire. If you lose a valve cap, buy another and install it as soon as possible. After you have changed wheels, always secure the flat tire in its place and return the jack and tools to their proper storage locations.

**CAUTION**

**Reusing lug nuts**

Make certain during wheel removal that the same nuts that were removed are reinstalled - or, if replaced, that nuts with metric threads and the same chamfer configuration are used. Your vehicle has metric threads on the wheel studs and nuts. Installation of a non-metric thread nut on a metric stud will not secure the wheel to the hub properly and will damage the stud so that it must be replaced.

Note that most lug nuts do not have metric threads. Be sure to use extreme care in checking for thread style before installing aftermarket lug nuts or wheels. If in doubt, consult an authorized Kia dealer.

**WARNING**

**Wheel studs**

If the studs are damaged, they may lose their ability to retain the wheel. This could lead to the loss of the wheel and a collision resulting in serious injuries.

**WARNING**

Never use oil or grease on bolts or nuts because the nuts might come loose. The vehicle's wheel could fall off, causing a crash.

**Important - use of compact spare tire (if equipped)**

Your vehicle is equipped with a compact spare tire. This compact spare tire takes up less space than a regular-size tire. This tire is smaller than a conventional tire and is designed for temporary use only.

- You should drive carefully when the compact spare is in use. The compact spare should be replaced by the proper conventional tire and rim at the first opportunity.
- The operation of this vehicle is not recommended with more than one compact spare tire in use at the same time.

**WARNING**

**Spare tire**

The compact spare tire is for emergency use only. Do not operate your vehicle on this compact spare at speeds over 80 km/h (50 mph). The original tire should be repaired or replaced as soon as possible to

avoid failure of the spare, possibly leading to bodily injury or death.

---

The compact spare tire should be inflated to 420 kPa (60 psi).

**\* NOTICE**

Check the inflation pressure after installing the spare tire. Adjust it to the specified pressure, as necessary.

---

When using a compact spare tire, observe the following precautions:

- Under no circumstances should you exceed 80 km/h (50 mph); a higher speed could damage the tire.
  - Ensure that you drive slowly enough for the road conditions to avoid all hazards. Any road hazard, such as a pothole or debris, could seriously damage the compact spare.
  - Any continuous road use of this tire could result in tire failure, loss of vehicle control, and possible personal injury.
  - Do not exceed the vehicle's maximum load rating or the load-carrying capacity shown on the sidewall of the compact spare tire.
  - Avoid driving over obstacles. The compact spare tire diameter is smaller than the diameter of a conventional tire and reduces the ground clearance approximately 25 mm (1 inch), which could result in damage to the vehicle.
  - Do not take this vehicle through an automatic vehicle wash while the compact spare tire is installed.
- Do not use the compact spare tire on any other vehicle because this tire has been designed especially for your vehicle.
  - The compact spare tire's tread life is shorter than a regular tire. Inspect your compact spare tire regularly and replace worn compact spare tires with the same size and design, mounted on the same wheel.
  - The compact spare tire should not be used on any other wheels, nor should standard tires, snow tires, wheel covers or trim rings be used with the compact spare wheel. If such use is attempted, damage to these items or other vehicle components may occur.
  - Do not use more than one compact spare tire at a time.
  - Do not tow a trailer while the compact spare tire is installed.

### Jack label

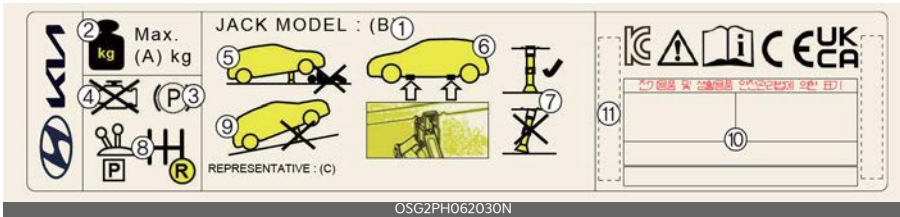

\* The actual Jack label in the vehicle may differ from the illustration. For more detailed specifications, refer to the label attached to the jack.

- 1 Model Name
- 2 Maximum allowable load
- 3 When using the jack, set your parking brake.
- 4 When using the jack, stop the engine.
- 5 Do not get under a vehicle that is supported by a jack.
- 6 The designated locations under the frame
- 7 When supporting the vehicle, the base plate of jack must be vertical under the lifting point.
- 8 Move the shift position to the P (Park) position on vehicles.
- 9 The jack should be used on firm level ground.
- 10 Jack manufacturer
- 11 Production date
- 12 Representative company and address

## If you have a flat tire (with tire mobility kit) (if equipped)

For safe operation, carefully read and follow the instructions in this manual before use.



**1** Sealant bottle

**2** Compressor

The Tire Mobility Kit is a temporary fix to the tire and have your vehicle inspected by an authorized Kia dealer.

\* The tire mobility kit will be provided in the cargo area or in a dedicated bag in the liftgate in the side trim.

### **CAUTION**

#### **One sealant for one tire**

When two or more tires are flat, do not use the tire mobility kit because the supported one sealant of Tire Mobility Kit is only used for one flat tire.

### **WARNING**

Do not use the Tire Mobility Kit to repair punctures in the tire walls. This can result in an accident due to tire failure.

### **WARNING**

Have your tire repaired as soon as possible. The tire may lose air pressure at any time after inflating with the Tire Mobility Kit.

## Introduction

With the Tire Mobility Kit you stay mobile even after experiencing a tire puncture.

The system of compressor and sealing compound effectively and comfortably seals most punctures in a passenger car tire caused by nails or similar objects and reinflates the tire.

After you ensured that the tire is properly sealed you can drive cautiously on the tire (distance up to 200 km (120 miles)) at a max. speed of 80 km/h (50 mph) in order to reach a service station or tire dealer to have the tire replaced.

It is possible that some tires, especially with larger punctures or damage to the sidewall, cannot be sealed completely.

Air pressure loss in the tire may adversely affect tire performance.

For this reason, you should avoid abrupt steering or other driving maneuvers, especially if the vehicle is heavily loaded or if a trailer is in use.

The Tire Mobility Kit is not designed or intended as a permanent tire repair method and is to be used for one tire only. This instruction shows you step by step how to temporarily seal the puncture simply and reliably.

Read the section "Notes on the safe use of the Tire Mobility Kit" on page 7-25.

### **WARNING**

Do not use the TMK if a tire is severely damaged by driving run flat or with insufficient air pressure.

Only punctured areas located within the tread region of the tire can be sealed using the TMK.

### Components of the Tire Mobility Kit



- 1 Speed-restriction label
- 2 Sealant bottle
- 3 Filling hose from sealant bottle to wheel
- 4 Connectors and cable for the power outlet direct connection
- 5 Holder for the sealant bottle
- 6 Compressor
- 7 ON/OFF switch
- 8 Pressure gauge for displaying the tire inflation pressure
- 9 Valve for reducing the tire inflation pressure

\* Connectors, cable and connection hose are stored in the compressor housing.

\* Strictly follow the specified sequence, otherwise the sealant may escape under high pressure.

**⚠ WARNING**

**Expired sealant**

Do not use the Tire sealant after the sealant has expired (i.e. past the expiration date on the sealant container). This can increase the risk of tire failure.

**⚠ WARNING**

**Sealant**

- Keep out of reach of children.
- Avoid contact with eyes.
- Do not swallow.

**Using the Tire Mobility Kit**

**⚠ CAUTION**

Detach the speed restriction label from the sealant bottle, and place it in a highly visible place inside the vehicle such as on the steering wheel to remind the driver not to drive too fast.



1. Shake the sealant bottle.



2. Connect the filling hose onto the connector of the sealant bottle. (A)  
Remove the sealant bottle cap and sealant bottle holder cap and connect

the bottle onto the sealant bottle holder. (B)

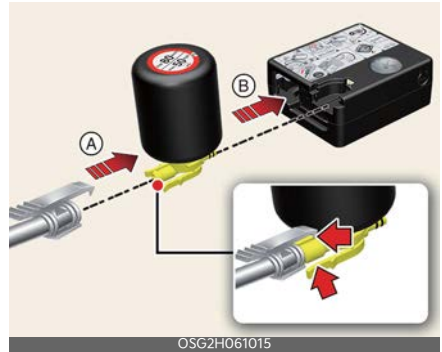

3. Make sure the compressor valve on the filling hose is locked.



4. Unscrew the valve cap from the valve of the defective tire and screw the filling hose of the sealant bottle onto the tire valve.



**⚠ CAUTION**

Securely install the sealant filling hose on the valve. If not, sealant may flow backward, possibly clogging the filling hose.

5. Ensure that the compressor is switched off, position 0.

6. Connect between compressor and the vehicle power outlet using the cable and connectors.



- 7. Make the ENGINE START/STOP button position on or ignition switch position on.
- 8. Switch on the compressor and let it run for approximately 5 ~ 7 minutes to fill the sealant up to proper pressure. (refer to "Tires and wheels" on page 8-31). The inflation pressure of the tire after filling is unimportant and will be checked/corrected later. Be careful not to overinflate the tire and stay away from the tire when filling it. When the tire and wheel are damaged, do not use Tire Mobility Kit for your safety.

**⚠ WARNING**

If the tire pressure is below 180kPa (26psi), do not drive the vehicle. The tire may cause accident.

- 9. Switch off the compressor.
- 10. Detach the sealant filling hoses from the sealant bottle connector and from the tire valve. After using, leave the sealant bottle and the compressor attached together.

Return the TMK to its storage location in the vehicle.

**⚠ WARNING**

**Carbon monoxide**

Do not leave your vehicle running in a poorly ventilated area for extended peri-

ods of time. Carbon monoxide poisoning and suffocation can occur.

**Distributing the sealant**



- Immediately drive approximately 7 ~ 10 km (4 ~ 6 miles or, about 10min) to evenly distribute the sealant in the tire.

**⚠ CAUTION**

Do not exceed a speed of 80 km/h (50 mph). If possible, do not fall below a speed of 20 km/h (12 mph).

While driving, if you experience any unusual vibration, ride disturbance or noise, reduce your speed and drive with caution until you can safely pull off of the side of the road. Call for road side service or towing.

When you use the Tire Mobility Kit, the wheel may be stained by sealant. Therefore, remove the wheel stained by sealant and have the vehicle inspected at an authorized Kia dealer.



## Checking the tire inflation pressure

1. After driving approximately 7 ~ 10 km (4 ~ 6 miles or about 10 min), stop at a safety location.
2. Connect the filling hose of the compressor directly to the tire valve.



3. Connect between compressor and the vehicle power outlet using the cable and connectors.

4. Adjust the tire inflation pressure to the recommended tire inflation.

With the ignition switched on, proceed as follows.

- To increase the inflation pressure: Switch on the compressor. To check the current inflation pressure setting, briefly switch off the compressor.
- Press the compressor valve to reduce the inflation pressure.

### ⚠ WARNING

Do not let the compressor run for more than 10 minutes, otherwise the device will overheat and may be damaged.

### ⚠ CAUTION

If the inflation pressure is not maintained, drive the vehicle a second time, refer to "Distributing the sealant" on page 7-24. Then repeat steps 1 to 4.

Use of the TMK may be ineffectual for tire damage larger than approximately 4 mm (0.16 of an inch).

Please contact the nearest Kia dealership if the tire cannot be made roadworthy with the Tire Mobility Kit.

### ⚠ WARNING

The tire inflation pressure must be at least 180 kPa (26 psi). If it is not, do not continue driving. Call for road side service or towing.

### \* NOTICE

When reinstalling the repaired or replaced tire and wheel on the vehicle, tighten the wheel lug nut to 11 ~ 13 kgf·m (79 ~ 94 lbf·ft).

## Notes on the safe use of the Tire Mobility Kit

- Park your car at the side of the road so that you can work with the TMK away from moving traffic. Place your warning triangle in a prominent place to make passing vehicles aware of your location.
- To be sure your vehicle will not move, even when you're on fairly level ground, always set your parking brake.
- Only use the TMK for sealing/inflation passenger car tires. Do not use on motorcycles, bicycles or any other type of tires.
- Do not remove any foreign objects—such as nails or screws—that have penetrated the tire.
- Before using the TMK, read the precautionary advice printed on the sealant bottle!
- Provided the car is outdoors, leave the engine running. Otherwise operating

the compressor may eventually drain the car battery.

- Never leave the TMK unattended while it is being used.
- Do not leave the compressor running for more than 10 min. at a time or it may overheat.
- Do not use the TMK if the ambient temperature is below -30°C (-22°F).
- When the tire and wheel are damaged, do not use Tire Mobility Kit for your safety.

**Technical Data**

- System voltage: DC 12 V
- Working voltage: DC 12 V
- Amperage rating: max. 10A ± 1A
- Suitable for use at temperatures: -30 to 70 °C (-22 to 158 °F)
- Max. working pressure: 87 psi
- Size
  - Compressor: 118 x 130 x 52 mm (5.9 x 5.1 x 2.4 in.)
  - Sealant bottle: 121 x 76 ø mm (4.5 x 3.4 ø in.)
  - Compressor weight: 470 ± 30 g (1.04 ± 0.07 lbs)
  - Sealant volume: 300 ml (18.3 cu. in.)

\* Sealant and spare parts can be obtained and replaced at an authorized vehicle or tire dealer. Empty sealant bottles may be disposed of at home. Liquid residue from the sealant should be disposed of by your vehicle or tire dealer or in accordance with local waste disposal regulations.

**Towing**

**Towing service**

If emergency towing is necessary, have it done by authorized Kia dealer or a commercial tow-truck service.

Proper lifting and towing procedures are necessary to prevent damage to the vehicle. The use of wheel dollies (1) or flatbed is recommended.

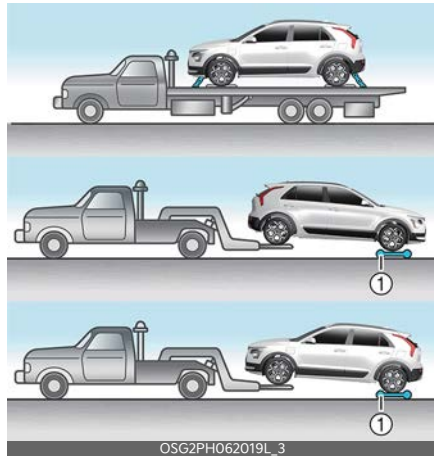

**CAUTION**

The AWD vehicle should never be towed with the wheels on the ground. This can cause serious damage to the transmission.

**WARNING**

**Side and curtain air bag**

If your vehicle is equipped with side and curtain air bag, set the ENGINE START/STOP button to ACC position when the vehicle is being towed.

The side and curtain air bag may deploy when the ENGINE START/STOP button

to ON position and the rollover sensor detects the situation as a rollover.

**\* NOTICE**

If the EPB does not release normally, take your vehicle to an authorized Kia dealer by loading the vehicle on a flat-bed tow truck and have the system checked.

**When flatbed is unavailable**

2-wheel drive vehicle can be towed with the opposite tires on the ground (without dollies) and parking brake released.

2-wheel drive vehicle (front wheeldrive)



Shift to N (Neutral) to tow a vehicle with the tires on the ground. For more details, refer to "Stay in N (Neutral) position when vehicle is Off" on page 6-26.

**⚠ WARNING**

**Side and curtain air bag**

If your vehicle is equipped with side and curtain air bag, set the ENGINE START/STOP button to ACC position when the vehicle is being towed.

The side and curtain air bag may deploy when the ENGINE START/STOP button to ON position and the rollover sensor detects the situation as a rollover.

**⚠ CAUTION**

**Towing gear position**

Failure to shift to N (Neutral) may cause internal damage to the vehicle.

**⚠ CAUTION**

- If any of the loaded wheels or suspension components are damaged or the vehicle is being towed with the front wheels on the ground, use a towing dolly under the front wheels.



- Do not tow the vehicle backwards with the front wheels on the ground, as this may cause damage to the transmission.

2-wheel drive vehicle (front wheeldrive)



- Attaching straps to the chassis, suspension or other parts of the body can cause damage.
- Do not tow with sling-type equipment. Use wheel lift or flatbed equipment.
- Do not tow the vehicle with four wheels in contact with the ground if it is the vehicle equipped with Dual clutch transmission. Otherwise, the transmission will be seriously damaged. Also, make sure not to tow the

vehicle connecting it with other vehicles including camper vans.

**WARNING**

- If you tow the vehicle while the front wheels are touching the ground, the vehicle motor may generate electricity and the motor components may be damaged or a fire may occur.
- When a vehicle fire occurs due to the battery, there is a risk of a second fire. Contact the fire department when towing the vehicle.

**Towing without wheel dollies when using a towing service**

When towing your vehicle in an emergency without wheel dollies:

1. Set the ignition switch or ENGINE START/STOP button to ACC position.
2. Place the shifter dial in N (Neutral).
3. Release the parking brake.

2-wheel drive vehicle (front wheel drive)



**CAUTION**

**Towing gear position**

Failure to shift to N (Neutral) may cause internal damage to the vehicle.

**CAUTION**

- If any of the loaded wheels or suspension components are damaged or the vehicle is being towed with the front

wheels on the ground, use a towing dolly under the front wheels.



- Do not tow the vehicle backwards with the front wheels on the ground, as this may cause damage to the transmission.

2-wheel drive vehicle (front wheeldrive)



- Attaching straps to the chassis, suspension or other parts of the body can cause damage.
- Do not tow with sling-type equipment. Use wheel lift or flatbed equipment.
- Do not tow the vehicle with four wheels in contact with the ground if it is the vehicle equipped with Dual clutch transmission. Otherwise, the transmission will be seriously damaged. Also, make sure not to tow the vehicle connecting it with other vehicles including camper vans.
- Accelerate or decelerate the vehicle in a slow and gradual manner while maintaining tension on the tow rope or chain to start or drive the vehicle, otherwise tow hooks and the vehicle may be damaged.

**⚠ WARNING**

- If you tow the vehicle while the front wheels are touching the ground, the vehicle motor may generate electricity and the motor components may be damaged or a fire may occur.
- When a vehicle fire occurs due to the battery, there is a risk of a second fire. Contact the fire department when towing the vehicle.

**Emergency towing**

Front



Rear



If towing is necessary, we recommend you have it done by an authorized Kia dealer or a commercial tow truck service.

If a towing service is not available in an emergency, your vehicle may be temporarily towed using a cable or chain secured to the emergency towing hook at the front (or rear) of the vehicle.

Use extreme caution when towing the vehicle with a cable or chain. A driver must be in the vehicle to steer it and operate the brakes.

Towing in this manner may be done only on hard-surfaced roads for a short distance and at low speeds. Also, the wheels, axles, power train, steering and brakes must all be in good condition. Always follow these emergency towing precautions:

- Place the ignition switch in the ACC position so the steering wheel is not locked.
- Place the shift button in N (Neutral).
- Release the parking brake.
- Depress the brake pedal with more force than normal as you will have reduced braking performance.
- More steering effort will be required because the power steering system will be disabled.
- Use a vehicle heavier than your own to tow your vehicle.
- The drivers of both vehicles should communicate with each other frequently.
- Before emergency towing, check that the hook is not broken or damaged.
- Fasten the towing cable or chain securely to the hook.
- Do not jerk the hook. Apply steady and even force.

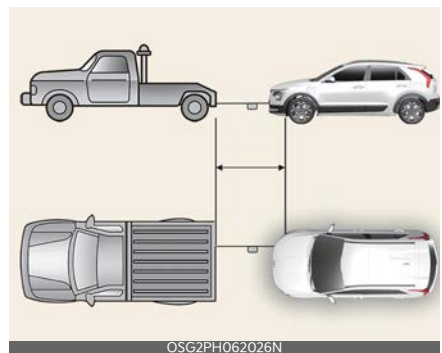

- Use a towing cable or chain less than 5 m (16 feet) long. Attach a white or red cloth (about 30 cm (12 inches) wide) in the middle of the cable or chain for easy visibility.
- Drive carefully so the towing cable or chain remains tight during towing.
- Before towing, check the dual clutch transmission for fluid leaks under your vehicle. If the dual clutch transmission fluid is leaking, flatbed equipment or a towing dolly must be used.
- The driver must be in the vehicle for steering and braking operations when the vehicle is towed and passengers other than the driver must not be allowed to be on board.
- To avoid serious damage to the dual clutch transmission, limit the vehicle speed to 15 km/h (10 mph) and drive less than 1.5 km (1 mile) when towing. (for Dual Clutch Transmission vehicle)

**\* NOTICE**

- To avoid damage to your vehicle and vehicle components when towing:
    - Always pull straight ahead when using the towing hooks. Do not pull from the side or at a vertical angle.
    - Do not use the towing hooks to pull a vehicle out of mud, sand or other conditions from which the vehicle cannot be driven out under its own power.
-

<b>Engine compartment</b> .....	<b>8-4</b>
<b>Maintenance services</b> .....	<b>8-5</b>
<b>Owner maintenance</b> .....	<b>8-6</b>
• Owner maintenance schedule .....	8-6
<b>Scheduled maintenance service</b> .....	<b>8-8</b>
• Scheduled maintenance service precaution .....	8-8
<b>Explanation of scheduled maintenance items</b> .....	<b>8-13</b>
• Engine oil and filter .....	8-13
• HSG (Hybrid Starter & Generator) belt.....	8-13
• Fuel filter .....	8-13
• Fuel lines, fuel hoses and connections.....	8-13
• Fuel tank and fuel cap .....	8-13
• Air cleaner filter.....	8-13
• Spark plugs.....	8-13
• Cooling system.....	8-13
• Coolant/inverter coolant .....	8-13
• Dual clutch transmission (DCT) fluid.....	8-13
• Brake hoses and lines .....	8-13
• Brake fluid.....	8-14
• Exhaust pipe and muffler.....	8-14
• Brake discs, pads and calipers.....	8-14
• Suspension mounting bolts.....	8-14
• Steering gear box, linkage & boots/lower arm ball joint.....	8-14
• Drive shafts and boots.....	8-14
• Air conditioning refrigerant .....	8-14
• Checking fluid levels.....	8-14
<b>Engine oil</b> .....	<b>8-15</b>
• Checking the engine oil level .....	8-15
• Changing the engine oil and filter .....	8-16
<b>Coolant</b> .....	<b>8-17</b>
• Checking the engine coolant level .....	8-17

# 8 Maintenance

• Checking the inverter coolant level (HEV).....	8-18
• Checking the inverter coolant level (PHEV).....	8-20
<b>Hybrid starter &amp; generator (HSG) belt .....</b>	<b>8-20</b>
• Checking the Hybrid Starter & Generator (HSG) belt.....	8-20
<b>Brake fluid .....</b>	<b>8-21</b>
• Checking the brake fluid level.....	8-21
<b>Engine clutch actuator fluid.....</b>	<b>8-22</b>
• Checking the engine clutch actuator fluid level.....	8-22
<b>Washer fluid .....</b>	<b>8-23</b>
• Checking the washer fluid level .....	8-23
<b>Air cleaner filter .....</b>	<b>8-23</b>
• Replacing air cleaner filter .....	8-23
<b>Climate control air filter.....</b>	<b>8-24</b>
• Filter inspection .....	8-24
<b>Wiper blades.....</b>	<b>8-25</b>
• Blade inspection .....	8-25
• Blade replacement .....	8-26
<b>Battery.....</b>	<b>8-28</b>
• For plug-in hybrid vehicle .....	8-28
• For hybrid vehicle .....	8-30
• Reset items .....	8-30
<b>Tires and wheels .....</b>	<b>8-31</b>
• Checking tire inflation pressure .....	8-32
• Tire rotation.....	8-32
• Wheel alignment and tire balance .....	8-33
• Tire replacement .....	8-33
• Wheel replacement.....	8-34
• Tire traction .....	8-34
• Tire maintenance .....	8-34
• Tire sidewall labeling.....	8-34



• Tire terminology and definitions .....	8-37
• All season tires.....	8-40
• Summer tires.....	8-40
• Snow tires .....	8-40
• Radial-ply tires.....	8-41
• Low aspect ratio tire .....	8-41
<b>Fuses .....</b>	<b>8-42</b>
• Inner panel fuse replacement .....	8-44
• Engine compartment fuse replacement .....	8-45
• Fuse/relay panel description.....	8-46
<b>Light bulbs.....</b>	<b>8-55</b>
• Bulb replacement precaution .....	8-55
• Light bulb position (Front).....	8-56
• Light bulb position (Rear) .....	8-56
• Light position (Side) .....	8-57
• Replacing lights (LED type).....	8-57
• Replacing headlamp (Low beam/High beam) (Bulb type).....	8-57
• Headlamp bulb .....	8-58
• Replacing rear turn signal lamp, backup lamp (Bulb type) .....	8-58
• Replacing high mounted stop lamp (LED type) .....	8-58
• Replacing license plate lamp (Bulb type).....	8-58
• Replacing map lamp (Bulb type) .....	8-59
• Replacing room lamp (Bulb type).....	8-59
• Replacing vanity mirror lamp (Bulb type) .....	8-60
• Replacing glove box lamp (Bulb type).....	8-60
• Replacing luggage lamp (Bulb type).....	8-61
<b>Appearance care.....</b>	<b>8-61</b>
• Exterior care .....	8-61
• Interior care .....	8-66
<b>Emission control system .....</b>	<b>8-68</b>
• Procedure for entering forced engine activation mode.....	8-70

# Maintenance Engine compartment

## Smartstream G1.6 GD<sub>i</sub> HEV

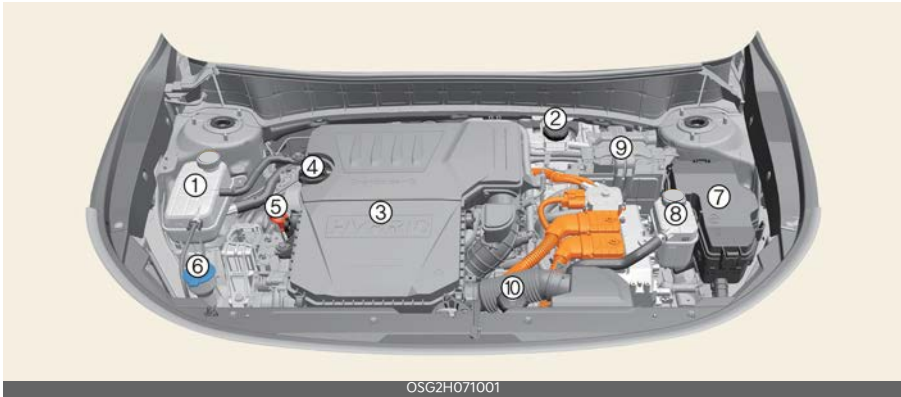

## Smartstream G1.6 GD<sub>i</sub> PHEV

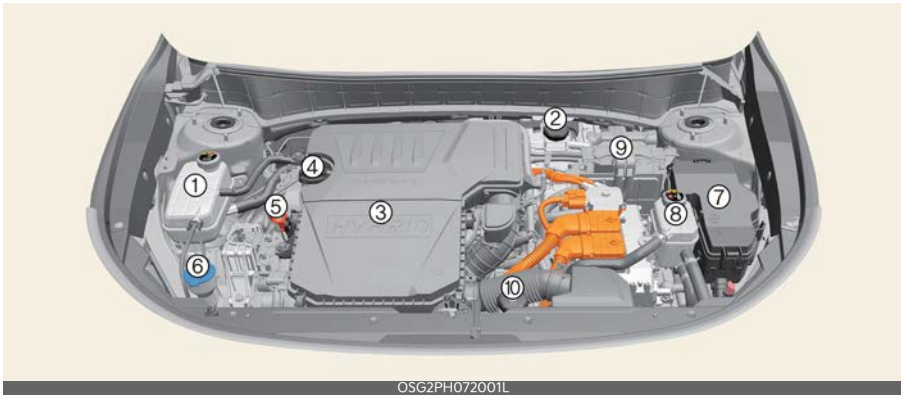

\* The actual engine room in the vehicle may differ from the illustration.

- |                                      |      |
|--------------------------------------|------|
| 1. Engine coolant reservoir          | 8-17 |
| 2. Brake fluid reservoir             | 8-21 |
| 3. Air cleaner                       | 8-23 |
| 4. Engine oil filler cap             | 8-15 |
| 5. Engine oil dipstick               | 8-15 |
| 6. Windshield washer fluid reservoir | 8-23 |
| 7. Fuse box                          | 8-42 |
| 8. Inverter coolant reservoir        | 8-18 |
| 9. Electric Control Unit (ECU)       | 7-5  |
| 10. Engine actuator reservoir tank   | 8-22 |

## Maintenance services

You should exercise the utmost care to prevent damage to your vehicle and injury to yourself whenever performing any maintenance or inspection procedures.

Should you have any doubts concerning the inspection or servicing of your vehicle, have an authorized Kia dealer perform this work.

An authorized Kia dealer has factory-trained technicians and genuine Kia parts to service your vehicle properly. For expert advice and quality service, see an authorized Kia dealer.

Inadequate, incomplete or insufficient servicing may result in operational problems with your vehicle that could lead to vehicle damage, an accident, or personal injury.

## Owner's responsibility

### \* NOTICE

Maintenance Service and Record Retention are the owner's responsibility.

You should retain documents that show proper maintenance has been performed on your vehicle in accordance with the scheduled maintenance service charts shown on the following pages. You need this information to establish your compliance with the servicing and maintenance requirements of your vehicle warranties.

Detailed warranty information is provided in your Warranty & Consumer Information manual.

Repairs and adjustments required as a result of improper maintenance or a lack of required maintenance are not covered.

Have your vehicle maintained and repaired by an authorized Kia dealer. Authorized Kia dealers meet Kia's high service quality standards and receive technical support from Kia in order to provide you with a high level of service satisfaction.

## Owner maintenance precautions

Improper or incomplete service may result in problems. This section gives instructions only for the maintenance items that are easy to perform.

As explained earlier in this section, several procedures can be done only by an authorized Kia dealer with special tools.

### \* NOTICE

Improper owner maintenance during the warranty period may affect warranty coverage. For details, read the separate Warranty & Consumer Information manual provided with the vehicle. If you're unsure about any servicing or maintenance procedure, have it done by an authorized Kia dealer.

### ⚠ WARNING

#### Maintenance work

Do not wear jewelry or loose clothing while working under the hood of your vehicle with the engine running. These items can become entangled in moving parts, if you must run the engine while working under the hood, make certain that you remove all jewelry (especially rings, bracelets, watches, and necklaces) and all neckties, scarves, and similar loose clothing before getting near cooling fans.

## WARNING

### Touching metal parts

Do not touch metal parts (including strut bars) while the vehicle is operating or hot. Doing so could result in serious bodily injury. Turn the vehicle off and wait until the metal parts cool down to perform maintenance work on the vehicle.

---

## Owner maintenance

The following lists are vehicle checks and inspections that should be performed by the owner or an authorized Kia dealer at the frequencies indicated to help ensure safe, dependable operation of your vehicle.

Any adverse conditions should be brought to the attention of your dealer as soon as possible.

These owner maintenance checks are generally not covered by warranties and you may be charged for labor, parts and lubricants used.

### Owner maintenance schedule

#### When you stop for fuel:

- Check the coolant level in coolant reservoir.
- Check the windshield washer fluid level.
- Look for low or under-inflated tires.
- Check if the front of the radiator and condenser are clean and not blocked with leaves, dirt or insects etc. If any of the above parts are extremely dirty or you are not sure of their condition, take your vehicle to an authorized Kia dealer.

## WARNING

### Hot coolant



Be careful when checking your engine coolant level when the engine is hot. Scalding hot coolant and steam may blow out under pressure.

---

**While operating your vehicle:**

- Note any changes in the sound of the exhaust or any smell of exhaust fumes in the vehicle.
- Check for vibrations in the steering wheel. Notice any increased steering effort or looseness in the steering wheel, or change in its straight-ahead position.
- Notice if your vehicle constantly turns slightly or "pulls" to one side when traveling on smooth, level road.
- When stopping, listen and check for unusual sounds, pulling to one side, increased brake pedal travel or "hard-to-push" brake pedal.
- If any slipping or changes in the operation of your transmission occurs, take your vehicle to an authorized Kia dealer.
- Check the transmission P (Park) function.
- Check the parking brake.
- Check for fluid leaks under your vehicle (water dripping from the air conditioning system during or after use is normal).

**At least monthly:**

- Check the coolant level in the coolant reservoir.
- Check the operation of all exterior lights, including the stoplights, turn signals and hazard warning flashers.
- Check the inflation pressures of all tires including the spare (if provided) for tires that are worn, show uneven wear, or are damaged.
- Check for loose wheel lug nuts.

**At least once every 6 months:**

- Check the radiator, heater and air conditioning hoses for leaks or damage.
- Check the windshield washer spray and wiper operation. Clean the wiper blades with clean cloth dampened with washer fluid.
- Check the headlamp alignment.
- Check the muffler, exhaust pipes, shields and clamps.
- Check the lap/shoulder belts for wear and function.

**At least once a year:**

- Clean the body and door drain holes.
- Lubricate the door hinges and check the hood hinges.
- Lubricate the door and hood locks and latches.
- Lubricate the door rubber weatherstrips.
- Check the air conditioning system.
- Inspect and lubricate transmission linkage and controls.
- Clean the battery and terminals.
- Check the brake fluid level.
- Visually inspect steering, suspension, and chassis components for damaged, loose, or missing parts or signs of wear.

## Scheduled maintenance service

### Scheduled maintenance service precaution

Follow the Normal Maintenance Schedule if the vehicle is usually operated where none of the following conditions apply. If any of the following conditions apply, follow the Maintenance Under Severe Usage Conditions.

- Repeated driving short distance of less than 8 km (5 miles) in normal temperature or less than 16 km (10 miles) in freezing temperature
- Extensive engine idling or low speed driving for long distances
- Driving on rough, dusty, muddy, unpaved, graveled or salt-spread roads
- Driving in areas using salt or other corrosive materials or in very cold weather
- Driving in heavy dust condition
- Driving in heavy traffic area
- Driving on uphill, downhill, or mountain road repeatedly
- Using for towing or camping and driving with loading on the roof
- Driving as a patrol car, taxi, other commercial use of vehicle towing
- Frequently driving under high speed or rapid acceleration/deceleration.
- Frequently driving in stop-and-go condition

If your vehicle is operated in any of the prior listed conditions, you should inspect, replace or refill more frequently, using the severe usage maintenance schedule instead of the normal usage maintenance schedule.

### \* NOTICE

The vehicle may be equipped with the Oil Life Management System that predicts engine oil life based on the driver's driving history and alerts the driver to change engine oil.

- If the deterioration of the engine oil increases depending on the driver's driving severity, the remaining oil life alert appears on the instrument cluster before the normal engine oil replacement interval. Have the engine oil and filter be changed by an authorized Kia dealer.
- Oil Life Management System when the recommended engine oil is used. So, if recommended engine oil is not used, replace the engine oil according to the maintenance schedule under severe usage condition. Also, check the amount of engine oil regularly as this system assumes that the engine oil is being filled normally.
- Always reset the remaining engine oil life whenever the engine oil is changed. Otherwise, the Oil Life Management System will not be correct.
- If there is no alert until the maximum maintenance interval, have vehicle be checked by an authorized Kia dealer.

### Normal maintenance schedule

The following maintenance services must be performed to ensure good emission control and performance. Keep receipts for all vehicle services to protect your warranty. Where both mileage and date are shown, the frequency of service is determined by whichever occurs first.

I: Inspect and adjust, correct, clean, or replace if necessary.  
 R: Replace or change.

Normal Maintenance Schedule												
Number of months or driving distance, whichever comes first												
Months	12	24	36	48	60	72	84	96	108	120	132	144
Miles x 1,000	8	16	24	32	40	48	56	64	72	80	88	96
Km x 1,000	13	26	39	52	65	78	91	104	117	130	143	156
Tire rotation		Rotate every 13,000 km (8,000 miles)										
Fuel additives <sup>1</sup>		Add every 13,000 km (8,000 miles) or 12 months										
Engine oil and engine oil filter <sup>2</sup>	Smartstream G1.6 GDI HEV/PHEV	R	R	R	R	R	R	R	R	R	R	R
Climate control air filter		I	R	I	R	I	R	I	R	I	R	I
Air cleaner filter (Engine)		I	I	R	I	I	R	I	I	R	I	I
Brake fluid		Inspect every 13,000 km (8,000 miles) or 12 months Replace every 78,000 km (48,000 miles) or 48 months										
Spark plugs	Smartstream G1.6 GDI HEV/PHEV	Replace every 156,000 km (96,000 miles)										
Coolant (Engine) <sup>3</sup>		At first, replace at 195,000 km (120,000 miles) or 120 months After that, replace every 39,000 km (24,000 miles) or 24 months										
Coolant (Inverter)	HEV <sup>4</sup>	At first, replace at 39,000 km (39,000 miles) or 120 months After that, replace every 39,000 km (24,000 miles) or 24 months										
	PHEV <sup>5</sup>	Replace every 52,000 km (32,000 miles) or 36 months										
Air conditioner refrigerant												
Air conditioner compressor												
Battery condition	PHEV											
Brake discs and pads												
Brake lines, hoses and connections		I	I	I	I	I	I	I	I	I	I	I
Suspension ball joints												
Steering gear rack, linkage and boots												
Exhaust system												
Cooling system												
Engine clutch actuator hose and line												
Drive shaft and boots												
Fuel tank and fuel cap		-	I	-	I	-	I	-	I	-	I	-
Fuel tank air filter												
Fuel lines, hoses and connections												
HSG (Hybrid Starter & Generator) belt <sup>6</sup>		Inspect every 13,000 km (8,000 miles) or 12 months Replace every 104,000 km (64,000 miles) or 48 months										

Normal Maintenance Schedule												
Number of months or driving distance, whichever comes first												
Months	12	24	36	48	60	72	84	96	108	120	132	144
Miles x 1,000	8	16	24	32	40	48	56	64	72	80	88	96
Km x 1,000	13	26	39	52	65	78	91	104	117	130	143	156
Dual clutch transmission (DCT) fluid <sup>7</sup>	No service required											
Engine clutch actuator fluid	Replace every 39,000 km (24,000 miles) or 24 months											

**\*1. Fuel additives**

Kia recommends that you use Tier 1 unleaded gasoline which has an octane rating of RON (Research Octane Number) 95/AKI (Anti Knock Index) 91 or higher.

For customers who do not use good quality gasolines including fuel additives regularly, and have problems starting or the engine does not run smoothly, one bottle of additives should be added to the fuel tank at every 13,000 km (8,000 miles).

Additives are available from an authorized Kia dealer. Do not mix with other additives.

**\*2. Engine oil and engine oil filter**

As it is normal for engine oil to be consumed during driving, the engine oil level should be checked on regular basis.

The engine oil change interval for normal operating conditions is based on the use of the recommended engine specification. If the recommended engine oil specification is not used, then replace the engine oil according to the maintenance schedule under severe operating conditions.

**\*3. Coolant (Engine)**

When adding coolant, use only deionized water or soft water for your vehicle and never mix hard water in the coolant filled at the factory. An improper coolant mixture can result in serious malfunction or engine damage.

**\*4. Coolant (HEV Inverter)**

When adding coolant, use only deionized water or soft water for your vehicle and never mix hard water in the coolant filled at the factory. An improper coolant mixture can result in serious malfunction or engine damage.

**\*5. Coolant (PHEV Inverter)**

Have the coolant replaced by an authorized Kia dealer.

**\*6.HSG (Hybrid Starter & Generator) belt**

Inspect HSG belt for evidence of cuts, cracks, excessive wear or oil saturation and replace if necessary.

**\*7. Dual clutch transmission (DCT) fluid**

If the vehicle has been submerged in water or in a flooded area, the fluids should be changed as a precaution.



## Fuel filter (Gasoline engine)

The fuel filter is considered to be maintenance free but periodic inspection is recommended for this maintenance schedule depends on fuel quality.

- If there are some important safety matters like fuel flow restriction, surging, loss of power, hard starting problem etc, replace the fuel filter immediately regardless of maintenance schedule and consult an authorized Kia dealer for details.

## Maintenance under severe usage conditions

I: Inspect and if necessary, adjust, correct, clean or replace.

R: Replace or change.

MAINTENANCE ITEM	MAINTENANCE OPERATION	MAINTENANCE INTERVALS	DRIVING CONDITION
Engine oil and engine oil filter	R	Every 8,000 km (5,000 miles) or 6 months	D, H, I
HSG (Hybrid Starter & Generator) belt	R	Every 48,000 km (30,000 miles) or 24 months	B, C, D, E, I, K
	I	Every 8,000 km (5,000 miles) or 6 months	
Spark plugs	R	More frequently	A, B, F, G, H, I, K
Air cleaner filter	R	More frequently	C, E
Climate control air filter	R	More frequently	C, E, G
Dual clutch transmission (DCT) fluid	R	Every 117,000 km ( )	C, D, F, G, H, I, J
Steering gear rack, linkage and boots	I	More frequently	C, D, E, F, G, H, I
Suspension ball joints	I	More frequently	C, D, E, G, H, I
Brake discs, pads and calipers	I	More frequently	C, D, E, G, H, I, J, K
Drive shaft and boots	I	More frequently	C, D, E, F, G, H, I, J

### Severe driving conditions

A: Repeatedly driving short distance of less than 8 km (5 miles) in normal temperature or less than 16 km (10 miles) in freezing temperature.

B: Extensive engine idling or low speed driving for long distances.

C: Driving on rough, dusty, muddy, unpaved, graveled or saltspread roads.

D: Driving in areas using salt or other corrosive materials or in very cold weather

E: Driving in heavy dust condition.

F: Driving in heavy traffic area.

G: Driving on uphill, downhill, or mountain roads repeatedly.

H: Using for towing or camping and driving with loading on the roof

I: Driving for patrol car, taxi, other commercial use of vehicle towing.

J: Frequently driving under high speed or rapid acceleration/deceleration

K: Frequently driving in stop-and-go conditions.

## Explanation of scheduled maintenance items

### Engine oil and filter

The engine oil and filter should be changed at the intervals specified in the maintenance schedule. If the vehicle is being driven in severe conditions, more frequent oil and filter changes are required.

### HSG (Hybrid Starter & Generator) belt

Inspect HSG belt for evidence of cuts, cracks, excessive wear or oil saturation and replace if necessary.

#### CAUTION

When you are inspecting the belt, place the ignition switch or ENGINE START/STOP button in the LOCK/OFF or ACC position.

### Fuel filter

The fuel filter is considered to be maintenance free but periodic inspection is recommended for this maintenance schedule depends on fuel quality. If there are some important safety matters like fuel flow restriction, surging, loss of power, hard starting problem etc., replace the fuel filter immediately regardless of maintenance schedule and consult an authorized Kia dealer for details.

### Fuel lines, fuel hoses and connections

Check the fuel lines, fuel hoses and connections for leakage and damage. Have the fuel lines, fuel hoses and connections replaced by an authorized Kia dealer.

### Fuel tank and fuel cap

The fuel tank and fuel cap should be inspected at those intervals specified in the maintenance schedule. Make sure that a new fuel tank and fuel cap is correctly replaced.

### Air cleaner filter

Have the air cleaner filter replaced by an authorized Kia dealer.

### Spark plugs

Make sure to install new spark plugs of the correct heat range.

When assembling parts, be sure to wipe the inside and outside of the boot bottom of the ignition coil and the insulator of the spark plug with a soft cloth to prevent contamination of the spark plug insulator.

#### WARNING

Do not disconnect and inspect spark plugs when the engine is hot. You may burn yourself.

### Cooling system

Check the cooling system components, such as the radiator, coolant reservoir, hoses and connections for leakage and damage. Replace any damaged parts.

### Coolant/inverter coolant

The coolant should be changed at the intervals specified in the maintenance schedule.

### Dual clutch transmission (DCT) fluid

Inspect the dual clutch transmission fluid according to the maintenance schedule.

### Brake hoses and lines

Visually check for proper installation, chafing, cracks, deterioration and any

leakage. Replace any deteriorated or damaged parts immediately.

### **Brake fluid**

Check the brake fluid level in the brake fluid reservoir. The level should be between "MIN" and "MAX" marks on the side of the reservoir. Use only hydraulic brake fluid conforming to DOT 4 specification.

### **Exhaust pipe and muffler**

Visually inspect the exhaust pipes, muffler and hangers for cracks, deterioration, or damage. Start the engine and listen carefully for any exhaust gas leakage. Tighten connections or replace parts as necessary.

### **Brake discs, pads and calipers**

Check the pads for excessive wear, discs for run out and wear, and calipers for fluid leakage.

### **Suspension mounting bolts**

Check the suspension connections for looseness or damage. Retighten to the specified torque.

### **Steering gear box, linkage & boots/lower arm ball joint**

With the vehicle stopped and engine off, check for excessive free-play in the steering wheel.

Check the linkage for bends or damage. Check the dust boots and ball joints for deterioration, cracks, or damage. Replace any damaged parts.

### **Drive shafts and boots**

Check the drive shafts, boots and clamps for cracks, deterioration, or damage. Replace any damaged parts and, if necessary, repack the grease.

### **Air conditioning refrigerant**

Check the air conditioning lines and connections for leakage and damage.

### **Checking fluid levels**

When checking engine oil, engine coolant, brake fluid, and washer fluid, always be sure to clean the area around any filler plug, drain plug, or dipstick before checking or draining any lubricant or fluid. This is especially important in dusty or sandy areas and when the vehicle is used on unpaved roads. Cleaning the plug and dipstick areas will prevent dirt and grit from entering the engine and other mechanisms that could be damaged.

## Engine oil

### Checking the engine oil level

Engine oil is used for lubricating, cooling, and operating various hydraulic components in the engine. Engine oil consumption while driving is normal, and it is necessary to check and refill the engine oil regularly. Also, check and refill the oil level within the recommended maintenance schedule to prevent deterioration of oil performance.

Check the engine oil following the below procedure.

#### Smartstream G1.6 GDi HEV/PHEV

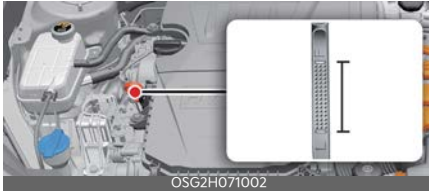

1. Be sure the vehicle is on level ground.
2. Start the engine and allow it to reach normal operating temperature.
3. Turn the engine off, remove the oil filler cap and pull the dipstick out. Wait for 15 minutes for the oil to return to the oil pan.
4. Wipe the dipstick clean and re-insert it fully.
5. Pull the dipstick out again and check the level. Check if the oil level is between the F-L line, and if it is below the L line, add enough oil to bring the level to F line.

### ⚠ WARNING

#### Radiator hose

Be very careful not to touch the radiator hose when checking or adding the engine oil as it may be hot enough to burn you.

### ⚠ CAUTION

When you wipe the oil level gauge, you should wipe it with a clean cloth. When mixed with debris, it can cause engine damage.

#### Smartstream G1.6 GDi HEV/PHEV



### Use a funnel to help prevent oil from being spilled on engine components.

Use only the specified engine oil. (Refer to "Recommended lubricants and capacities" on page 9-6.)

- Do not spill engine oil when adding or changing engine oil. Wipe off spilled oil immediately.
- The engine oil consumption may increase while you break in a new vehicle and it will be stabilized after driving 6,000 km (4,000 miles).
- The engine oil consumption can be affected by driving habits, climate conditions, traffic conditions, oil quality, etc. Therefore, it is recommended that you inspect the engine oil level regularly and refill it if necessary.

## Changing the engine oil and filter

The lubrication, rust prevention, cooling, and cleaning effect of the engine oil will gradually degrade during its use. Have the engine oil and filter changed by an authorized Kia dealer according to the Engine Oil Life Management System instructions or the maintenance schedule.

- If the maintenance schedule to replace engine oil is exceeded, the engine oil performance may deteriorate, and the engine condition may be affected. Therefore, replace the engine oil according to the maintenance schedule.
- To keep the engine in optimal condition, use the recommended engine oil and filter. If the recommended engine oil and filter are not used replace it according to the maintenance schedule under severe usage conditions.
- The purpose of the maintenance schedule for engine oil replacement is to prevent oil deterioration and it is irrelevant to oil consumption. Check and refill engine oil regularly.

### WARNING

#### Used engine oil

Used engine oil may cause irritation or cancer of the skin if left in contact with the skin for prolonged periods of time. Always protect your skin by washing your hands thoroughly with soap and warm water as soon as possible after handling used oil. Do not leave used engine oil within the reach of children.

### NOTICE

- When the oil pressure is low due to insufficient engine oil, the Engine Oil

Pressure () warning light will appear.

In addition, the enhanced engine protection system, which limits the engine's power is activated and the Malfunction Indicator Lamp () will appear when the vehicle is driven in this state continuously.

- When oil pressure is restored, the Engine Oil Pressure warning light will turn off and the engine power will no longer be limited.
- When oil pressure is restored, the Engine Oil Pressure warning light will turn off and the engine power will no longer be limited.

### CAUTION

The engine oil is very hot immediately after the vehicle has been driven and can cause burns during replacement. Replace the engine oil after the engine oil has cooled down.

## Coolant

The high-pressure cooling system has a reservoir filled with year round anti-freeze coolant. The reservoir is filled at the factory.

Check the antifreeze protection and coolant level at least once a year, at the beginning of the winter season, and before traveling to a colder climate.

### Checking the engine coolant level

When adding coolant, use only deionized water, distilled water or soft water for your vehicle and never mix hard water in the coolant filled at the factory.

- An incorrect coolant mixture can result in severe malfunction or engine/hybrid system damage.
- The engine in your vehicle has aluminum engine parts and must be protected by an phosphate-based ethylene glycol coolant to prevent corrosion and freezing.
- Do not use alcohol or methanol coolant or mix them with the specified coolant.
- Do not use a solution that contains more than 60% antifreeze or less than 35% antifreeze, which would reduce the effectiveness of the solution.



### ⚠ WARNING

Make sure the engine coolant reservoir cap is properly closed after refill or coolant.

Otherwise the engine could be overheated while driving.

1. Check if the engine coolant reservoir cap label is straight in front.



2. Make sure that the tiny protrusions inside the engine coolant reservoir cap are securely interlocked.



### ⚠ WARNING



### Removing engine coolant reservoir cap

Never attempt to remove the engine coolant reservoir cap while the engine is operating or hot. Doing so might lead to cooling system damage and could result in serious personal injury from escaping hot coolant or steam.

**⚠ WARNING**

Turn the vehicle off and wait until the engine cools down. Use extreme care when removing the engine coolant cap. Wrap a thick towel around it, and turn it slowly to the first stop. Step back while the pressure is released from the cooling system. When you are sure all the pressure has been released, press down on the cap, using a thick towel, and continue turning to remove it.

**\* NOTICE**

The engine coolant level is influenced by the hybrid system temperature. Before checking or refilling the engine coolant, turn the hybrid vehicle off.

**\* NOTICE**

For mixture percentage, refer to the following table.

Ambient Temperature	Mixture Percentage (volume)	
	Antifreeze	Water
-15 °C (5°F)	35	65
-25 °C (-13°F)	40	60
-35 °C (-31°F)	50	50
-45 °C (-49°F)	60	40

**\* NOTICE**

To prevent damage to engine parts, put a thick towel around the engine coolant cap and/or inverter coolant cap before refilling the coolant to prevent the coolant from overflowing into engine parts, such as the alternator.

**Changing the coolant**

We recommend that the coolant be replaced by an authorized Kia dealer according to the Maintenance Schedule at the beginning of this chapter.

**⚠ WARNING**

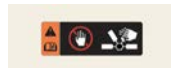

**Cooling fan**

Use caution when working near the blade of the cooling fan. The electric motor (cooling fan) is controlled by coolant temperature, refrigerant pressure and vehicle speed. It may sometimes operate even when the vehicle is not running.

**Checking the inverter coolant level (HEV)**

If frequent additions are required, we recommend that the system be inspected by an authorized Kia dealer.

The inverter coolant level should be in between MAX and MIN when the engine is cooled down.

**⚠ WARNING**

Adding other cooling substances or water might lead to inverter cooling system degradation or even failure.



- Turn the vehicle off and wait until it cools down.
- Use extreme care when removing the inverter coolant reservoir cap. Wrap a thick towel around it, and turn it slowly to the first stop.



- Step back while the pressure is released from the cooling system.
- When you are sure all the pressure has been released, press down on the cap, using a thick towel, and continue turning to remove it.
- Check the condition and connections of all cooling system hoses and heater hoses.
- Replace any swollen or deteriorated hoses.
- Check the coolant level. The coolant level should be filled between MAX and MIN marks on the side of the coolant reservoir when the engine room is cool.
- If the coolant level is low, add enough specified coolant to provide protection against freezing and corrosion. Bring the level to MAX, but do not overfill.

**WARNING**

Make sure the inverter coolant reservoir cap is properly closed after refill or coolant.

Otherwise the inverter could be overheated while driving.

1. Check if the inverter coolant reservoir cap label is straight in front.



2. Make sure that the tiny protrusions inside the inverter coolant reservoir cap are securely interlocked.



**WARNING**

**Removing inverter coolant reservoir cap**

Never remove the inverter coolant reservoir cap while the engine and radiator are hot. Hot coolant and steam may blow out under pressure, causing serious injury.

**Changing the coolant**

We recommend that the coolant be replaced by an authorized Kia dealer according to the Maintenance Schedule at the beginning of this chapter.

**WARNING**

**Cooling fan**

Use caution when working near the blade of the cooling fan. The electric motor (cooling fan) is controlled by coolant temperature, refrigerant pressure and vehicle speed. It may sometimes operate even when the vehicle is not running.

## Checking the inverter coolant level (PHEV)

If frequent additions are required, we recommend that the system be inspected by an authorized Kia dealer.

The inverter coolant level should be in between MAX and MIN when the engine is cooled down.

### WARNING

Adding other cooling substances or water might lead to inverter cooling system degradation or even failure.

### WARNING



#### Removing inverter coolant reservoir cap

Never remove the inverter coolant reservoir cap while the engine and radiator are hot. Hot coolant and steam may blow out under pressure, causing serious injury.

## Changing the coolant

We recommend that the coolant be replaced by an authorized Kia dealer according to the Maintenance Schedule at the beginning of this chapter.

### WARNING



#### Cooling fan

Use caution when working near the blade of the cooling fan. The electric motor (cooling fan) is controlled by coolant temperature, refrigerant pressure and vehicle speed. It may sometimes operate even when the vehicle is not running.

## Hybrid starter & generator (HSG) belt

### Checking the Hybrid Starter & Generator (HSG) belt

We recommend that you have the Hybrid Starter & Generator (HSG) belt inspected or replaced according to the Maintenance Schedule in this chapter by an authorized Kia dealer.

### CAUTION

When the HSG belt is worn out or damaged, replace the belt. Otherwise, it may cause engine overheating or battery discharge.

### WARNING

- Turn the vehicle off while you inspect the engine or Hybrid Starter & Generator (HSG) belt. Otherwise it may result in serious injury.
- Keep hands, clothing etc. away from the Hybrid Starter & Generator (HSG) belt

## Brake fluid

### Checking the brake fluid level

Check the fluid level in the reservoir periodically. The fluid level should be between MAX and MIN marks on the side of the reservoir.

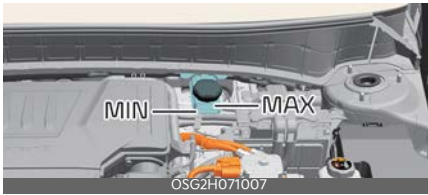

1. Before removing the reservoir cap and adding brake fluid, clean the area around the reservoir cap thoroughly to prevent brake fluid contamination.
2. Periodically check that the fluid level in the brake fluid reservoir is between MIN and MAX. The level will fall with accumulated mileage. This is a normal condition associated with the wear of the brake linings.

If the fluid level is excessively low, have the system checked by an authorized Kia dealer.

Use only the specified brake fluid. (Refer to "Recommended lubricants and capacities" on page 9-6.)

Never mix different types of fluid.

### **⚠ WARNING**

#### Loss of brake fluid

In the event the brake system requires frequent additions of fluid, have the system inspected by an authorized Kia dealer.

### **⚠ WARNING**

#### Brake fluid

When changing and adding brake fluid, handle it carefully. Do not let it come in contact with your eyes. If brake fluid should come in contact with your eyes, immediately flush them with a large quantity of fresh tap water. Have your eyes examined by a doctor as soon as possible.

### **⚠ CAUTION**

#### Proper fluid

Only use brake fluid in the brake system. Even small amounts of improper fluids can cause damage to the brake system.

### **⚠ CAUTION**

#### Brake fluid

Do not allow brake fluid to contact the vehicle's body paint, as paint damage will result.

The brake fluid constantly absorbs moisture from the air. This lowers the boiling point of the brake fluid. If the boiling point is too low, vapor pockets may form in the brake system when the brakes are applied hard.

## Engine clutch actuator fluid

### Checking the engine clutch actuator fluid level



In normal driving conditions, the actuator fluid level does not go down rapidly. However, oil consumption rate may rise as vehicle mileage increases, and leakage in actuator related parts may result in increased consumption of the engine clutch actuator oil. Regularly check and make sure the engine clutch actuator oil fluid level is between MIN and MAX marks.

If the oil level is below MIN mark, have the vehicle checked by an authorized Kia dealer.

If the fluid level is excessively low, have the system checked by an authorized Kia dealer.

Use only the specified engine clutch actuator fluid. (Refer to "Recommended lubricants and capacities" on page 9-6.) Never mix different types of fluid.

- Check the fluid level in the engine clutch actuator fluid reservoir and add fluid if necessary.

The reservoir is translucent so that you can check the level with a quick visual inspection.

### **⚠ CAUTION**

Do not allow the engine clutch actuator fluid to contact the vehicle's body paint, as paint damage will result. The engine clutch actuator fluid, which has been exposed to open air for an extended

time should never be used as its quality cannot be guaranteed. It should be properly disposed. Don't put in the wrong kind of fluid. A few drops of mineral-based oil, such as engine oil, in your engine clutch system can damage engine clutch system parts.

### **⚠ WARNING**

- In the event the engine clutch system requires frequent additions of fluid, have the system inspected by an authorized Kia dealer.
- When changing and adding the engine clutch actuator fluid, handle it carefully. Do not let it come in contact with your eyes. If engine clutch actuator fluid should come in contact with your eyes, immediately flush them with a large quantity of fresh tap water. Have your eyes examined by a doctor as soon as possible.

## Washer fluid

### Checking the washer fluid level

The reservoir is translucent so that you can check the level with a quick visual inspection.



- Check the fluid level in the washer fluid reservoir and add fluid if necessary. Plain water may be used if washer fluid is not available.

However, use washer solvent with antifreeze characteristics in cold climates to prevent freezing.

### **⚠ WARNING**

#### Washer fluid

- Do not use radiator coolant or anti-freeze in the washer fluid reservoir.
- Radiator coolant can severely obscure visibility when sprayed on the windshield and may cause loss of vehicle control or damage to paint and body trim.
- Windshield Washer fluid agents contain some amounts of alcohol and can be flammable under certain circumstances. Do not allow sparks or flame to contact the washer fluid or the washer fluid reservoir. Damage to the vehicle or occupants could occur.
- Windshield washer fluid is poisonous to humans and animals. Do not drink and avoid contacting windshield washer fluid. Serious injury or death could occur.

## Air cleaner filter

A genuine Kia air cleaner filter is recommended when the filter is replaced.

### Replacing air cleaner filter

Air cleaner filter must be replaced when necessary, and should not be washed.

You can clean the filter when inspecting the air cleaner compartment. Clean the filter by using compressed air.

1. Loosen the air cleaner cover attaching clips (1) and open the cover (2).



2. Wipe the inside of the air cleaner. Replace air cleaner filter.



3. Lock the cover with the cover attaching clips. Assemble in reverse order.

Replace the filter according to the Maintenance Schedule.

### **\* NOTICE**

If the vehicle is operated in extremely dusty or sandy areas, replace the element more often than the usual recommended intervals. (Refer to "Scheduled maintenance service" on page 8-8.)

**⚠ CAUTION**

**Air filter maintenance**

- Do not drive with the air cleaner removed; this will result in excessive engine wear.
- When removing the air cleaner filter, be careful that dust or dirt does not enter the air intake, or damage may result.
- Use a Kia genuine part. Use of a non-genuine part could damage the air flow sensor.

**Climate control air filter**

**Filter inspection**

The climate control air filter should be replaced according to the maintenance schedule. If the vehicle is operated in severely air-polluted cities or on dusty rough roads for a long period, it should be inspected more frequently and replaced earlier. When you replace the climate control air filter, replace it performing the following procedure, and be careful to avoid damaging other components.

**Operation**

1. Open the glove box and remove the stopper (1).

With the glove box open, remove the glove box by pushing the both sides of it (2).



2. Remove the climate control air filter cover (2) by pulling out both sides (1) of the cover.

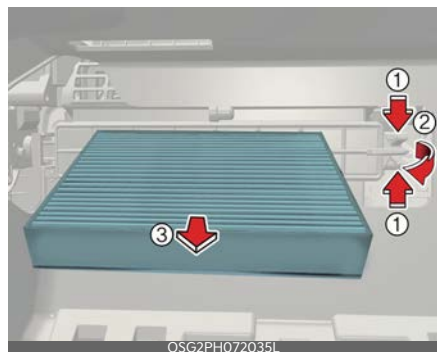

3. Replace the climate control air filter (3).



4. Assemble in reverse order.

### \* NOTICE

When replacing the climate control air filter install it properly. Otherwise, the system may produce noise and the effectiveness of the filter may be reduced.

## Wiper blades

When the wipers no longer clean adequately, the blades may be worn or cracked, and require replacement.

To prevent damage to the wiper arms or other components, do not attempt to move the wipers manually.

The use of a non-specified wiper blade could result in wiper malfunction and failure.

## Blade inspection



### \* NOTICE

Commercial hot waxes applied by automatic car washes have been known to make the windshield difficult to clean.

Contamination of either the windshield or the wiper blades with foreign matter can reduce the effectiveness of the windshield wipers. Common sources of contamination are insects, tree sap, and hot wax treatments used by some commercial car washes. If the blades are not wiping properly, clean both the window and the blades with a good cleaner or mild detergent, and rinse thoroughly with clean water.

### ⚠ CAUTION

To prevent damage to the wiper blades, do not use gasoline, kerosene, paint thinner, or other solvents on or near them.

## Blade replacement

When the wipers no longer clean adequately, the blades may be worn or cracked, and require replacement.

### ⚠ CAUTION

To prevent damage to the wiper arms or other components, do not attempt to move the wipers manually.

### ⚠ CAUTION

The use of a non-specified wiper blade could result in wiper malfunction and failure.

## Front wiper blade replacement



For your convenience and to prevent hood paint damage, you must move the windshield wiper blades to the service position as follows.

After turning off the engine, move the wiper switch to the single wiping (MIST) position within 20 seconds and hold the switch more than 2 seconds until the wiper blade is in the fully up position.

### ⚠ CAUTION

#### Wiper arms

- Do not allow the wiper arm to fall against the windshield, since it may chip or crack the windshield.
- Do not pull the wiper arm forward, since arm could chip hood paint.

1. Raise the wiper arm and turn the wiper blade assembly to expose the plastic locking clip.



2. Compress the clip and slide the blade assembly downward.



3. Lift it off the arm.
4. Install the blade assembly in the reverse order of removal.

## Rear wiper blade replacement



1. Within 20 seconds after the vehicle ignition is OFF, move the wiper lever to MIST position for over 2 seconds until the wiper moves down to the bottom middle part.
2. Raise the wiper arm and pull out the wiper blade assembly.





OSG2H071016

- Lift up the wiper blade, and pull the blade to remove it.



ONQ5061126N

- Install the new blade assembly by inserting the center part into the slot in the wiper arm until it clicks into place.

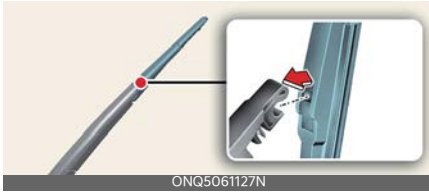

ONQ5061127N

- Make sure the blade assembly is installed firmly by trying to pull it slightly.  
If the replacement is complete, put down the wiper arm to place it on the rear windshield, and turn the vehicle ignition to ON and operate the wipers to check the blade is installed correctly.

To prevent damage to the wiper arms or other components, have the wiper blade replaced by an authorized Kia dealer.

### ⚠ CAUTION

If the wiper arm receives too much force while pulling the blade, the center part may be damaged.

### ⚠ CAUTION

- The wiper could not operate for approx. 10 seconds when the wiper is operated without washer fluid or the blades are frozen. This is not a malfunction, it is a wiper protection system activated by motor overload circuit within the wiper motor.
- The front windshield should be cleaned with water hose and wiped with clean towel with wiper blades raised up. Also, the wiper blades should be wiped clean when the grease or wax is applied to the blades.

## Battery

### For plug-in hybrid vehicle

### For best battery service



- Keep the battery securely mounted.
- Keep the battery top clean and dry.
- Keep the terminals and connections clean, tight, and coated with petroleum jelly or terminal grease.
- Rinse any spilled electrolyte from the battery immediately with a solution of water and baking soda.
- If the vehicle is not going to be used for an extended time, disconnect the battery cables.

#### \* NOTICE

Your vehicle is equipped with maintenance free battery. If your vehicle is equipped with the battery marked with LOWER and UPPER on the side, you can check the electrolyte level. The electrolyte level should be between LOWER and UPPER. If the electrolyte level is low, it needs to add distilled (demineralized) water (Never add sulfuric acid or other electrolyte). When refill, be careful not to splash the battery and adjacent components. And do not overfill the battery cells. It can cause corrosion on other parts. Make sure that the cell caps are tightened.

Contact an authorized Kia dealer.

#### ⚠ WARNING

##### Risk of explosion



Keep lit cigarettes and all other flames or sparks away from the battery.



The battery contains hydrogen -- a highly combustible gas which will explode if it comes in contact with a flame or

spark.



Keep batteries out of the reach of children because batteries contain highly corrosive SULFURIC ACID and electrolytes.

Do not allow battery acid to contact your skin, eyes, clothing or paint finish.



Wear eye protection when charging or working near a battery. Always provide ventilation when working in an

enclosed space.



Always read the following instructions carefully when handling a battery.



If any electrolyte gets into your eyes, flush your eyes with clean water for at least 15 minutes and get immediate medical attention. If electrolyte gets on your skin, thoroughly wash the contacted area. If you feel pain or burning sensation, get medical attention immediately.



An inappropriately disposed battery can be harmful to the environment and human health. Dispose the battery according to your local law(s) or regulation.



The battery contains lead. Do not dispose of it after use. Please return the battery to an authorized Kia dealer to be recycled.

recycled.

Never attempt to recharge the battery when the battery cables are connected.

### **WARNING**

#### **Risk of electrocution**

Never touch the electrical ignition system while the vehicle is running. This system works with high voltage, which can "zap" you.

### **\* NOTICE**

If you connect unauthorized electronic devices to the battery, the battery may be discharged. Never use unauthorized devices.

### **WARNING**

#### **Recharging battery**

Never attempt to recharge the battery when the battery cables are connected.

### **WARNING**

#### **Battery lead compound**

Battery posts, terminals, and related accessories contain lead and lead compounds. Wash hands after handling.

## **Battery recharging**

Your vehicle has a maintenance-free, calcium-based battery.

- If the battery becomes discharged in a short time (because, for example, the headlamps or interior lights were left on while the vehicle was not in use), recharge it by slow charging (trickle) for 10 hours.
- If the battery gradually discharges because of high electric load while the vehicle is being used, recharge it at 20 ~ 30 A for two hours.

When recharging the battery, observe the following precautions:

- The battery must be removed from the vehicle and placed in an area with good ventilation.
- Do not allow cigarettes, sparks, or flame near the battery.
- Watch the battery during charging, and stop or reduce the charging rate in following cases:
  1. the battery cells begin gassing (boiling) violently
  2. the electrolyte temperature of any cell exceeds 49 °C (120 °F).
- Wear eye protection when checking the battery during charging.
- Before performing maintenance or recharging the battery, turn off all accessories and stop the vehicle.
- Disconnect the battery charger in the following order.
  1. Turn off the battery charger main switch.
  2. Unhook the negative clamp from the negative battery terminal.
  3. Unhook the positive clamp from the positive battery terminal.

- The negative battery cable must be removed first and installed last when the battery is disconnected.

### For hybrid vehicle

The 12V auxiliary battery of the vehicle is integrated within the high-voltage battery. The high-voltage battery is located under the 2nd row seat cushion.

For battery related servicing, contact an authorized Kia dealer.

### 12V auxiliary battery connector



Disconnect the 12V auxiliary battery connector located inside the engine room compartment to shut down the power of the 12V auxiliary battery.

Connect the 12V auxiliary battery connector again after the battery related maintenance is finished.

### ⚠ CAUTION

- The efficiency of the battery decreases during low temperature. If the vehicle is not used for the extended period of time, park the vehicle indoors if possible.
- Always keep the battery charged to the full capacity. The battery case may damage due to freezing if the battery capacity is low.
- Do not install unauthorized electrical devices (e.g. lamps, dashcam, etc.) to a vehicle. It may discharge the battery.

### Reset items

The following items should be reset after the battery has been discharged or the battery terminal (For plug-in hybrid vehicle) or battery connector (For hybrid vehicle) has been disconnected.

- Auto up/down window (Refer to "Window opening and closing" on page 5-46)
- Trip computer (Refer to "Trip information (trip computer)" on page 5-92)
- Climate control system (Refer to "Automatic climate control system" on page 5-129)
- Sunroof (Refer to "Sunroof (if equipped)" on page 5-56)
- Driver's seat position (Refer to "Driver Position Memory System (if equipped)" on page 5-33)
- Trip computer information settings (Refer to "LCD displays" on page 5-92)
- Radio presets

## Tires and wheels

For proper maintenance, safety, and maximum fuel economy, you must always maintain the recommended tire pressures and stay within the load limits and weight distribution recommended for your vehicle.

### Recommended cold tire inflation pressures

All tire pressures should be checked when the tires are cold. "Cold Tires" means the vehicle has not been driven for at least three hours or driven less than 1.6 km (1 mile).

Recommended pressures must be maintained for the best ride, vehicle handling, and minimum tire wear.

For recommended pressure, refer to "Tires and wheels" on page 9-5.

All specifications (sizes and pressures) can be found on a label attached to the driver's side center pillar.



### **⚠ WARNING**

#### Tire underinflation

Inflate your tires consistent with the instructions provided in this manual. Regularly check the tire inflation pressure, and correct it as needed; at least twice a month and before any long trips on the road. If you fail

to observe this precaution, you may be driving on underinflated tires, which may not only compromise your vehicle's driving stability, but may also lead to tire damage and the risk of an accident. This risk is much higher on hot days and when driving for long periods at high speeds.

Failure to maintain specified pressure may result in excessive wear, poor handling, reduced fuel economy, deformation of tire and/or wheel, harsh ride conditions, possibility for additional damage from road hazards, or result in tire failure.

#### Tire pressure

Always observe the following:

- Check tire pressure when the tires are cold. (After vehicle has been parked for at least three hours or hasn't been driven more than 1.6 km (1 mile) since startup.)
- Check the pressure of your spare tire each time you check the pressure of other tires. (if equipped)
- Never overload your vehicle. Be careful not to overload a vehicle luggage rack if your vehicle is equipped with one.
- Warm tires normally exceed recommended cold tire pressures by 28 ~ 41 kPa (4 ~ 6 psi). Do not release air from warm tires to adjust the pressure or the tires will be underinflated.

 **WARNING**

### Tire Inflation

Overinflation or underinflation can reduce tire life, adversely affect vehicle handling, and lead to sudden tire failure. This could result in loss of vehicle control and potential injury.

### Checking tire inflation pressure

Check your tires once a month or more.

Use a good quality gauge to check tire pressure. You cannot tell if your tires are properly inflated simply by looking at them. Radial tires may look properly inflated even when they're underinflated.

Check the tire's inflation pressure when the tires are cold. "Cold" means your vehicle has been sitting or at least three hours or driven no more than 1.6 km (1 mile).

1. Remove the valve cap from the tire valve stem.
2. Press the tire gauge firmly onto the valve to get a pressure measurement. If the cold tire inflation pressure matches the proper pressure on the tire and loading information label, no further adjustment is necessary.
3. If the pressure is low, add air until you reach the recommended amount.
4. If you overfill the tire, release air by pushing on the metal stem in the center of the tire valve.

5. Recheck the tire pressure with the tire gauge.
6. Be sure to put the valve caps back on the valve stems. They help prevent leaks by keeping out dirt and moisture.

Inspect your tires frequently for proper inflation as well as wear and damage. Always use a tire pressure gauge.

Tires with too much or too little pressure wear unevenly. This could result in poor handling, loss of vehicle control, and sudden tire failure leading to accidents, injuries, and even death. The recommended cold tire pressure for your vehicle can be found in this manual and on the tire label located on the driver's side center pillar.

### Tire rotation

To equalize tread wear, it is recommended that the tires be rotated every 13,000 km (8,000 miles) or sooner if irregular wear develops.

During rotation, check the tires for correct balance.

When rotating tires, check for uneven wear and damage. Abnormal wear is usually caused by incorrect tire pressure, improper wheel alignment, out-of-balance wheels, severe braking or severe cornering. Look for bumps or bulges in the tread or side of tire. Replace the tire if you find either of these conditions. Replace the tire if fabric or cord is visible. After rotation, be sure to bring the front and rear tire pres-

tures to specification and check lug nut tightness. (proper torque is 11 ~ 13 kgf-m [79 ~ 94 lbf-ft])

Refer to "Tires and wheels" on page 9-5.

Disc brake pads should be inspected for wear whenever tires are rotated.

With a full-size spare tire (if equipped)

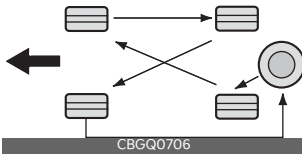

Without a spare tire

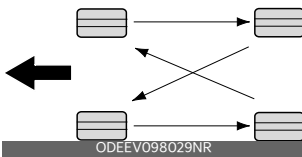

Directional tires (if equipped)

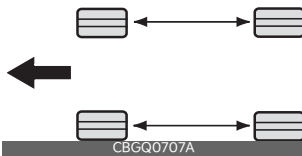

Rotate radial tires that have an asymmetric tread pattern only from front to rear and not from right to left.

**⚠ WARNING**

**Mixing tires**

Do not mix bias ply and radial ply tires under any circumstances. This may cause unusual handling characteristics.

**Wheel alignment and tire balance**

The wheels on your vehicle were aligned and balanced carefully at the factory to give you the longest tire life and best overall performance.

If you notice unusual tire wear or your vehicle pulling one way or the other, the alignment may need to be reset.

If you notice your vehicle vibrating when driving on a smooth road, your wheels may need to be rebalanced.

**⚠ CAUTION**

**Wheel weight**

Improper wheel weights can damage your vehicle's aluminum wheels. Use only approved wheel weights.

**Tire replacement**

If the tire is worn evenly, a tread wear indicator will appear as a solid band across the tread.



[A]: Tread wear indicator

This shows there is less than 4 mm (0.16 of an inch) of tread left on the tire. Replace the tire when this happens.

Do not wait for the band to appear across the entire tread before replacing the tire.

The Anti-lock Brake System (ABS) works by comparing the speed of the wheels. The tire size affects wheel speed. When replacing tires, all 4 tires must use the same size originally supplied with the vehicle. Using tires of a different size can cause the ABS and Electronic Stability Control (ESC) to work irregularly. It is best to replace all four tires at the same time. If that is not possible, or necessary, then replace the two front or two rear tires as a pair. Replacing just one tire can seriously affect your vehicle's handling.

#### \* NOTICE

We recommend that when replacing tires, use the same originally supplied with the vehicles. If not, that affects driving performance.

### Wheel replacement

When replacing the metal wheels for any reason, make sure the new wheels are equivalent to the original factory units in diameter, rim width and offset.

A wheel with an incorrect size may adversely affect many things: wheel and bearing life, braking and stopping abilities, handling characteristics, ground clearance, body-to-tire clearance, snow chain clearance, speedometer and odometer calibration, headlamp aiming and bumper height.

#### ⚠ CAUTION

### Wheels

Wheels that do not meet Kia specifications may fit poorly and result in damage to the vehicle or unusual handling and poor vehicle control.

### Tire traction

Tire traction can be reduced if you drive on worn tires, tires that are improperly inflated or on slippery road surfaces.

Tires should be replaced when tread wear indicators appear. Slow down whenever there is rain, snow or ice on the road to reduce the possibility of losing control of the vehicle.

### Tire maintenance

In addition to proper inflation, correct wheel alignment helps to decrease tire wear.

If you find a tire is worn unevenly, have your dealer check the wheel alignment.

Make sure the newly installed tires are balanced correctly to increase vehicle ride comfort and tire life. In addition, always rebalance the tire when the tire is removed from the wheel.

### Tire sidewall labeling

This information identifies and describes the fundamental characteristics of the tire and also provides the Tire Identification Number (TIN) for safety standard certification.





The TIN can be used to identify the tire in case of a recall.

## 1. Manufacturer or brand name

Manufacturer or Brand name is shown.

## 2. Tire size designation

A tire's sidewall is marked with a tire size designation. You will need this information when selecting replacement tires for your vehicle. The following explains what the letters and numbers in the tire size designation mean.

Example tire size designation:

(These numbers are provided as an example only; your tire size designation could vary depending on your vehicle.)

### **P225/45R18 105V**

- P: Applicable vehicle type (tires marked with the prefix "P" are intended for use on passenger vehicles or light trucks; however, not all tires have this marking).
- 225: Tire width in millimeters.
- 45: Aspect ratio. The tire's section height as a percentage of its width.
- R: Tire construction code (Radial).

- 18: Rim diameter in inches.
- 105: Load Index, a numerical code associated with the maximum load the tire can carry.
- V: Speed Rating Symbol. See the speed rating chart in this section for additional information.

## Wheel size designation

Wheels are also marked with important information that you need if you ever have to replace one. The following explains what the letters and numbers in the wheel size designation mean.

Example wheel size designation:

### **7.5J x 18**

- 7.5: Rim width in inches.
- J: Rim contour designation.
- 18: Rim diameter in inches.

## Tire speed ratings

The chart below lists many of the different speed ratings currently being used for passenger vehicle tires. The speed rating is part of the tire size designation on the sidewall of the tire. This symbol corresponds to that tire's designed maximum safe operating speed.

Speed Rating Symbol	Maximum Speed
S	180 km/h (112 mph)
T	190 km/h (118 mph)
H	210 km/h (130 mph)
V	240 km/h (149 mph)
W	270 km/h (168 mph)
Y	300 km/h (186 mph)

### 3. Checking tire life

Any tires that are over 6 years old, based on the manufacturing date, should be replaced by new ones. You can find the manufacturing date on the tire sidewall (possibly on the inside of the wheel), displaying the DOT code. The DOT code is a series of numbers on a tire consisting of numbers and English letters. The manufacturing date is designated by the last four digits (characters) of the DOT code.

#### **DOT: XXXX XXXX OOOO**

The front part of the DOT means a plant code number, tire size and tread pattern and the last four numbers indicate week and year manufactured.

For example:

DOT XXXX XXXX 1622 represents that the tire was produced in the 16th week of 2022.

#### **⚠ CAUTION**

#### **Tire age**

Replace tires within the recommended time frame. Failure to replace tires as recommended can result in sudden tire failure, which could lead to a loss of control and an accident.

### 4. Tire ply composition and material

The number of layers or plies of rubber-coated fabric in the tire. Tire manufacturers also must indicate the materials in the tire, which include steel, nylon, polyester, and others. The letter "R" means radial ply construction; the letter "D" means diagonal or bias ply construction; and the letter "B" means belted-bias ply construction.

### 5. Maximum permissible inflation pressure

This number is the greatest amount of air pressure that should be put in the tire. Do not exceed the maximum inflation pressure. Refer to "Certification label" on page 6-194 for recommended inflation pressure.

### 6. Maximum load rating

This number indicates the maximum load in kilograms and pounds that can be carried by the tire. When replacing the tires on the vehicle, always use a tire that has the same load rating as the factory installed tire.

### 7. Uniform Tire Quality Grading

Quality grades can be found where applicable on the tire sidewall between tread shoulder and maximum section width.

For example:

- Treadwear 200
- Traction AA

- Temperature A

Tires degrade over time, even when they are not being used. Regardless of the remaining tread, we recommend that tires be replaced after approximately six (6) years of normal service. Heat caused by hot climate or frequent high loading conditions can accelerate the aging process.

### Tread wear

The tread wear grade is a comparative rating based on the wear rate of the tire when tested under controlled conditions on a specified government test course. For example, a tire graded 150 would wear one-and-a-half times (1½) as well on the government course as a tire graded 100.

The relative performance of tires depends upon the actual conditions of their use. Performance may depart significantly from the norm due to variations in driving habits, service practices and differences in road characteristics and climate.

These grades are molded on the side-walls of passenger vehicle tires. The tires available as standard or optional equipment on your vehicle may vary with respect to grade.

### Traction - AA, A, B & C

The traction grades, from highest to lowest, are AA, A, B and C. Those grades represent the tire's ability to stop on wet pavement as measured under controlled conditions on spec-

ified government test surfaces of asphalt and concrete. A tire marked C may have poor traction performance.

The traction grade assigned to this tire is based on straight-ahead braking traction tests, and does not include acceleration, cornering, hydroplaning, or peak traction characteristics.

### Temperature -A & B

Sustained high temperature can cause the material of the tire to degenerate and reduce tire life, and excessive temperature can lead to sudden tire failure. Grades B and A represent higher levels of performance on the laboratory test wheel than the minimum required by law.

### Tire terminology and definitions

Refer to the following for detailed definitions of the terms that are found in the tire description.

**Air Pressure** The amount of air inside the tire pressing outward on the tire. Air pressure is expressed in pounds per square inch (psi) or kilopascal (kPa).

**Accessory Weight** The combined weight of optional accessories. Some examples of optional accessories are dual clutch transmission, power seats, and air conditioning.

**Aspect Ratio** The relationship of a tire's height to its width.

**Belt** A rubber coated layer of cords that is located between the plies and

the tread. Cords may be made from steel or other reinforcing materials.

**Bead** The tire bead contains steel wires wrapped by steel cords that hold the tire onto the rim.

**Bias Ply Tire** A pneumatic tire in which the plies are laid at alternate angles less than 90 degrees to the centerline of the tread.

**Cold Tire Pressure** The amount of air pressure in a tire, measured in pounds per square inch (psi) or kilopascals (kPa) before a tire has built up heat from driving.

**Curb Weight** The weight of a motor vehicle with standard and optional equipment (including the maximum capacity of fuel, oil and coolant), but without passengers and cargo.

**DOT Markings** The DOT code includes the Tire Identification Number (TIN), an alphanumeric designator which can also identify the tire manufacturer, production plant, brand and date of production.

**GVWR** Gross Vehicle Weight Rating

**GAWR FRT** Gross Axle Weight Rating for the Front axle.

**GAWR RR** Gross Axle Weight Rating for the Rear axle.

**Intended Outboard Sidewall** The side of an asymmetrical tire that must always face outward when mounted on a vehicle.

**Kilopascal (kPa)** The metric unit for air pressure.

**Light truck (LT) tire** A tire designated by its manufacturer as primarily intended for use on

lightweight trucks or multipurpose passenger vehicles.

**Load ratings** The maximum load that a tire is rated to carry for a given inflation pressure.

**Load Index** An assigned number ranging from 1 to 279 that corresponds to the load carrying capacity of a tire.

**Maximum Inflation Pressure** The maximum air pressure to which a cold tire may be inflated. The maximum air pressure is molded onto the sidewall.

**Maximum Load Rating** The load rating for a tire at the maximum inflation pressure for that tire.

**Maximum Loaded Vehicle Weight** The sum of curb weight; accessory weight; vehicle capacity weight; and production options weight.

**Normal Occupant Weight** The number of occupants a vehicle is designed to seat multiplied by 68 kg (150 lbs.).

**Occupant Distribution** Designated seating positions.

**Outward Facing Sidewall** The side of a asymmetrical tire that has a particular side that faces outward when mounted on a vehicle. The outward facing sidewall bears white lettering or bears manufacturer, brand, and/or model name molding that is higher or deeper than the same moldings on the inner facing sidewall.

**Passenger (P-Metric) Tire** A tire used on passenger cars and some light duty trucks and multipurpose vehicles.

**Ply** A layer of rubber-coated parallel cords.

**Pneumatic tire** A mechanical device made of rubber, chemicals, fabric and steel or other materials, that, when mounted on an automotive wheel, provides the traction and contains the gas or fluid that sustains the load.

**Production options weight** The combined weight of installed regular production options weighing over 2.3 kg (5 lbs.) in excess of the standard items which they replace, not previously considered in curb weight or accessory weight. Examples include heavy duty brakes, ride levers, roof rack, heavy duty battery, and special trim.

### **Recommended Inflation Pressure**

Vehicle manufacturer's recommended tire inflation pressure and shown on the tire placard.

**Radial Ply Tire** A pneumatic tire in which the ply cords that extend to the beads are laid at 90 degrees to the centerline of the tread.

**Rim** A metal support for a tire and upon which the tire beads are seated.

**Sidewall** The portion of a tire between the tread and the bead.

**Speed Rating** An alphanumeric code assigned to a tire indicating the maximum speed at which a tire can operate.

**Traction** The friction between the tire and the road surface. The amount of grip provided.

**Tread** The portion of a tire that comes into contact with the road.

**Treadwear Indicators** Narrow bands, sometimes called "wear bars," that show across the tread of a tire when only 1.6 mm (2/32 inch) of tread remains.

**UTQGS** Uniform Tire Quality Grading Standards, a tire information system that provides consumers with ratings for a tire's traction, temperature and treadwear. Ratings are determined by tire manufacturers using government testing procedures. The ratings are molded into the sidewall of the tire.

**Vehicle Capacity Weight** The weight of designated seating positions multiplied by 68 kg (150 lbs.) plus the rated cargo and luggage load.

### **Vehicle Maximum Load on the Tire**

Load on an individual tire due to curb and accessory weight plus maximum occupant and cargo weight.

### **Vehicle Normal Load on the Tire**

Load on an individual tire that is determined by distributing to each axle its share of the curb weight, accessory weight, and normal occupant weight and driving by 2.

**Vehicle Placard** A label permanently attached to a vehicle showing the original equipment tire size and recommended inflation pressure.

### **All season tires**

Kia specifies all season tires on some models to provide good performance for use all year round, including snowy and icy road conditions.

All season tires are identified by ALL SEASON and/or M+S (Mud and Snow) on the tire sidewall. Snow tires have better snow traction than all season tires and may be more appropriate in some areas.

### **Summer tires**

Kia specifies summer tires on some models to provide superior performance on dry roads.

Summer tire performance is substantially reduced in snow and ice. Summer tires do not have the tire

traction rating M+S (Mud and Snow) on the tire side wall. If you plan to operate your vehicle in snowy or icy conditions, Kia recommends the use of snow tires or all season tires on all four wheels.

### **Snow tires**

If you equip your vehicle with snow tires, they should be the same size and have the same load capacity as the original tires.

Snow tires should be installed on all four wheels; otherwise, poor handling may result.

Snow tires should carry 28 kPa (4 psi) more air pressure than the pressure recommended for the standard tires on the tire label on the driver's side of the center pillar, or up to the maximum pressure shown on the tire sidewall, whichever is less.

Do not drive faster than 120 km/h (75 mph) when your vehicle is equipped with snow tires.

### **⚠ WARNING**

Do not use summer tires at temperatures below 7 °C (45 °F) or when driving on snow or ice. At temperatures below 7 °C (45 °F), summer tires can lose elasticity, and therefore traction and braking power as well. Change the tires on your vehicle to winter or all-weather tires of the same size as the standard tires of the vehicle. Both types of tires are identified by the M+S (Mud and Snow) marking. Using summer tires at very cold temperatures could

cause cracks to form, thereby damaging the tires permanently.

### Radial-ply tires

Radial-ply tires provide improved tread life, road hazard resistance and smoother high speed ride.

The radial-ply tires used on this vehicle are of belted construction, and are selected to complement the ride and handling characteristics of your vehicle. Radial-ply tires have the same load carrying capacity, as bias-ply or bias belted tires of the same size, and use the same recommended inflation pressure.

Mixing of radial-ply tires with bias-ply or bias belted tires is not recommended. Any combinations of radial-ply and bias-ply or bias belted tires when used on the same vehicle will seriously deteriorate vehicle handling. The best rule to follow is: Identical radial-ply tires should always be used as a set of four.

Longer wearing tires can be more susceptible to irregular tread wear. It is very important to follow the tire rotation interval shown in this section to achieve the tread life potential of these tires. Cuts and punctures in radial-ply tires are repairable only in the tread area, because of sidewall flexing. Consult your tire dealer for radial-ply tire repairs.

### Low aspect ratio tire (if equipped)

Low aspect ratio tires, whose aspect ratio is lower than 50, are provided for sporty looks.

Because the low aspect ratio tires are optimized for handling and braking, it may be more uncomfortable to ride in and there is more noise compare with normal tires.

#### CAUTION

Because the sidewall of the low aspect ratio tire is shorter than the normal, the wheel and tire of the low aspect ratio tire is easier to be damaged. So, follow the instructions below.

- When driving on a rough road or off road, drive cautiously because tires and wheels may be damaged. And after driving, inspect tires and wheels.
- When passing over a pothole, speed bump, manhole, or curb stone, drive slowly so that the tires and wheels are not damaged.
- If the tire is impacted, we recommend that you inspect the tire condition or contact an authorized Kia dealer.
- To prevent damage to the tire, inspect the tire condition and

pressure every 3,000 km (1,900 miles).

- It is not easy to recognize the tire damage with your own eyes. But if there is the slightest hint of tire damage, even though you cannot see the tire damage with your own eyes, have the tire checked or replaced because the tire damage may cause air leakage from the tire.
- If the tire is damaged by driving on a rough road, off road, pothole, manhole, or curb stone, it will not be covered by the warranty.
- You can find out the tire information on the tire sidewall.

### Fuses

Blade type



Cartridge type



Multi fuse



BFT

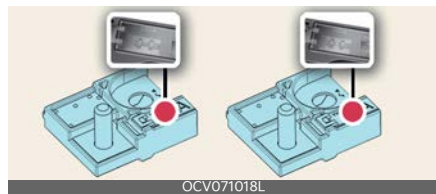

\* Left side: Normal, Right side: Blown

\* The actual fuse/relay panel label may differ from equipped items.

A vehicle's electrical system is protected from electrical overload damage by fuses.

This vehicle has 2 (or 3) fuse panels, one located in the driver's side panel bolster, the other in the engine compartment near the battery.



If any of your vehicle's lights, accessories, or controls do not work, check the appropriate circuit fuse. If a fuse has blown, the element inside the fuse will melt.

If the electrical system does not work, first check the driver's side fuse panel. If the replacement fuse blows, this indicates an electrical problem. Avoid using the system involved and immediately consult an authorized Kia dealer.

Three kinds of fuses are used: blade type for lower amperage rating, cartridge type, and multi fuse for higher amperage ratings.

### WARNING

#### Fuse replacement

- Never replace a fuse with anything but another fuse of the same rating.
- A higher capacity fuse could cause damage and possibly a fire.
- Never install a wire or aluminum foil instead of the proper fuse - even as a temporary repair. It may cause extensive wiring damage and a possible fire.
- Do not arbitrarily modify or add-on electric wiring to the vehicle.

### CAUTION

Do not use a screwdriver or any other metal object to remove fuses because it may cause a short circuit and damage the system.

### NOTICE

- When replacing a fuse, turn the ignition 'OFF' and turn off switches of all electrical devices then disconnect the (-) battery terminal (For plug-in hybrid

vehicle) or battery connector (For hybrid vehicle).

- **Window tinting precaution**

Window tint (especially metallic film) might cause communication disorder or poor radio reception, and malfunction of the automatic lighting system due to excessive change of illumination inside the vehicle. The solution used might also flow into electric, electronic devices causing disorder and failure.

- **Window tinting precaution**

Window tint (especially metallic film) might cause communication disorder or poor radio reception, and malfunction of the automatic lighting system due to excessive change of illumination inside the vehicle. The solution used might also flow into electric, electronic devices causing disorder and failure.

### WARNING

#### Electrical fire

Always ensure replacement fuses and relays are securely fastened when installed. Failure to do so can result in a vehicle fire.

Do not remove fuses, relays and terminals fastened with bolts or nuts. The fuses, relays and terminals may be fastened incompletely, and it may cause a possible fire. If fuses, relays and terminals fastened with bolts or nuts are blown, consult with an authorized Kia dealer.

**⚠ CAUTION**

When replacing a blown fuse or relay, make sure the new fuse or relay fits tightly into the clips. Failure to tightly install the fuse or relay may cause damage to the wiring and electric systems.

**⚠ CAUTION**

- Do not input any other objects except fuses or relays into fuse/relay terminals such as a screwdriver or wiring. It may cause contact failure and system malfunction.
- Do not plug in screwdrivers or aftermarket wiring into the terminal originally designed for fuse and relays only. The electrical system and wiring of the vehicle interior may be damaged or burned due to contact failure.
- If you directly connect the wire on the taillamp or replace the bulb which is over the regulated capacity to install trailers etc., the inner junction block can get burned.

**⚠ WARNING****Electrical wiring repairs**

All electrical repairs should be performed by authorized Kia dealerships using approved Kia parts. Using other wiring components, especially when retrofitting multimedia or theft alarm system, car phone or radio may cause vehicle damage and increase the risk of a vehicle fire.

**\* NOTICE****Remodeling prohibited**

Do not rewire your vehicle in any way as doing so may affect the performance of several safety features in your vehicle. Rewiring your vehicle may also void your warranty and cause you to be responsible for any subsequent vehicle damage which may result.

**Inner panel fuse replacement**

1. Turn the ignition switch or ENGINE START/STOP button and all other switches off.
2. Open the fuse panel cover.



3. Pull the suspected fuse straight out. Use the removal tool provided in the main fuse box in the engine compartment.



4. Check the removed fuse; replace it if it is blown. Spare fuses are provided in the instrument panel fuse panel (or in the engine compartment fuse panel).
5. Push in a new fuse of the same rating, and make sure it fits tightly in the clips.

If it fits loosely, consult an authorized Kia dealer.

If you do not have a spare, use a fuse of the same rating from a circuit you may not need for operating the vehicle, such as the cigarette lighter fuse.

If the headlamps or taillamps, stoplights, courtesy lamp, day time running lights (DRL) do not work and the fuses are OK, consult an authorized Kia dealer.

### Engine compartment fuse replacement

#### Blade/cartridge type fuse replacement



1. Turn the vehicle and all other switches off.
2. Remove the fuse panel cover by pressing the tab and pulling the cover up. When the blade type fuse is disconnected, remove it by using the clip (1) designed for changing fuses located in the engine room fuse box. Upon removal, securely insert reserve fuse of equal quantity.



3. Check the removed fuse; replace it if it is blown. To remove or insert the

fuse, use the fuse puller in the engine compartment fuse panel.

4. Push in a new fuse of the same rating, and make sure it fits tightly in the clips. If it fits loosely, consult an authorized Kia dealer.

#### ⚠ CAUTION

After checking the fuse panel in the engine compartment, securely install the fuse panel cover through the audible clicking sound.

If not, electrical failures may occur from water contact.

#### \* NOTICE

If the multi fuse is blown, consult an authorized Kia dealer.

#### \* NOTICE

The electronic system may not function correctly even when the engine room and internal fuse box's individual fuses are not disconnected. In such case the cause of the problem may be disconnection of the main fuse (BFT type), which is located inside the battery terminal (+) cap (For plug-in hybrid vehicle). Since the main fuse is designed more intricately than other parts, visit the nearest authorized Kia dealer.

### Main/multi fuse replacement



1. Turn off the vehicle.

2. Remove the fuse panel cover by pressing the tab and pulling the cover up.
3. Disconnect the (-) battery terminal (For plug-in hybrid vehicle) or battery connector (For hybrid vehicle).
4. Remove the nuts shown in the picture above.
5. Replace the fuse with a new one of the same rating.
6. Reinstall in the reverse order of removal.
7. If it fits loosely, consult an authorized Kia dealer.

### ⚠ CAUTION

Visually inspect the battery cap for secure closing. If the battery cap is not securely latched, the electrical system may be damaged to due influx of moisture into the system.

## Relay fuse replacement



1. Turn the vehicle and all other switches off.
2. Remove the fuse panel cover by pressing the tab and pulling the cover up.
3. Replace the relay with a new one of the same rating.
4. Reinstall in the reverse order of removal.
5. If it fits loosely, consult an authorized Kia dealer.

### ⚠ CAUTION

- After checking the fuse panel in the engine compartment, securely install the fuse panel cover through the audible clicking sound. If not, electrical failures may occur from water contact.
- Visually inspect the battery cap for secure closing. If the battery cap is not securely latched, the electrical system may be damaged to due influx of moisture into the system.

### \* NOTICE

- The electronic system may not function correctly even when the engine room and internal fuse box's individual fuses are not disconnected. In such case the cause of the problem may be disconnection of the main fuse (BFT type), which is located inside the positive battery terminal (+) cap (For plug-in hybrid vehicle). Since the main fuse is designed more intricately than other parts, visit an authorized Kia dealer.
- If the multi fuse is blown, consult a professional workshop. Kia recommends to consult an authorized Kia dealer/service partner.

## Fuse/relay panel description

Inside the fuse/relay panel covers, you can find the fuse/relay label describing fuse/relay name and capacity.

### \* NOTICE

Not all fuse panel descriptions in this manual may be applicable to your vehicle. It is accurate at the time of printing. When you inspect the fuse panel in your vehicle, refer to the fuse panel label.

### Driver's side fuse panel



### \* NOTICE

Not all fuse panel descriptions in this manual may be applicable to your vehicle. It is accurate at the time of printing. When you inspect the fuse panel in your vehicle, refer to the fuse panel label.

For hybrid vehicle

CHILD LOCK	10A	15A			<sup>2</sup> WIPER FRT	10A	A/BAG IND	7.5A	FCA	10A		START	7.5A		HEATED MIRROR	10A
TAILGATE OPEN	10A	15A			WIPER RR	15A	<sup>3</sup> MODULE	7.5A	CLUSTER	7.5A	<sup>2</sup> IG3		<sup>1</sup> IBU	10A	SUNROOF	30A
<sup>3</sup> E-SHIFTER		<sup>5</sup> HEATER FRT	20A	WASHER	15A			<sup>2</sup> IBU	7.5A	<sup>3</sup> IG3		<sup>3</sup> IG3	BATTERY MANAGEMENT	10A	<sup>2</sup> AIR BAG	10A
		P/WINDOW LH	25A	SPARE	<sup>2</sup> E-SHIFTER			<sup>4</sup> MODULE	10A	SPARE	15A	MEMORY	10A	SPARE		
AMP	30A	P/WINDOW RH	25A	<sup>6</sup> MODULE	<sup>5</sup> MODULE			<sup>2</sup> MDPS	7.5A	USB CHARGER	10A	SPARE	10A	IAU	BRAKE SWITCH	10A
P/SEAT DRV	30A			A/C	<sup>1</sup> AIR BAG	15A	<sup>2</sup> IGI	<sup>2</sup> MODULE	10A	10A	15A	MULTI MEDIA	25A	DOOR LOCK	<sup>1</sup> MODULE	10A
P/SEAT PASS	30A	<sup>5</sup> HEATER RR	25A	<sup>7</sup> MODULE	7.5A											

USE THE DESIGNATED FUSE ONLY  
UTILISEZ SEULEMENT LE FUSIBLE DÉSIGNÉS

P/N: 91990-AT020

OSG2PH072006N

For Plug-in hybrid vehicle

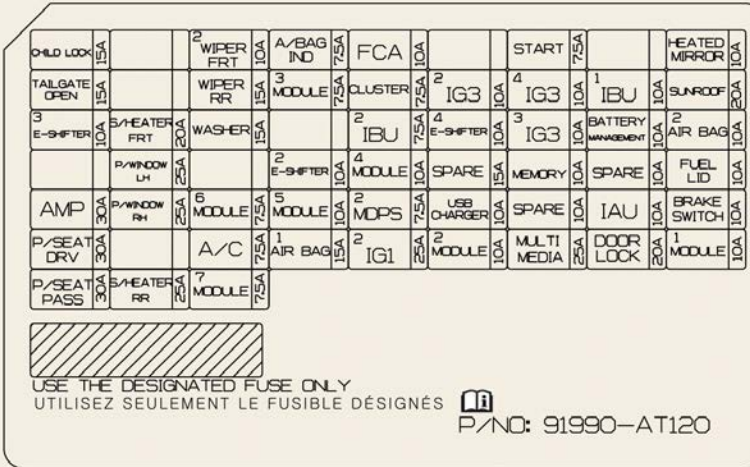

OSG2PH072007N

### ICU Junction Block

Fuse Name	Fuse Rating	Circuit Protected
CHILD LOCK	15A	Electronic child safety lock system
WIPER FRT 2	10A	Front Wiper Motor
A/BAG IND	7.5A	Instrument Cluster
FCA	10A	Front Radar
START	7.5A	Burglar Alarm Relay, HPCU (Hybrid Power Control Unit), IBU (Integrated Body Control Unit)
HEATED MIRROR	10A	Driver/Passenger Power Outside Mirror
TAILGATE OPEN	15A	Liftgate open Relay
WIPER RR	15A	Rear Wiper Relay, Rear Wiper Motor
MODULE 3	7.5A	Overhead Console, Multifunction Switch, Stop Lamp Switch
CLUSTER	7.5A	INSTRUMENT CLUSTER, HEAD UP DISPLAY
IG3 2	10A	BATTERY MANAGEMENT SYSTEM

Fuse Name	Fuse Rating	Circuit Protected
IG3 4	10A	AUDIO/ NAVIGATION HEAD UNIT, CHARGING IND, INSTRUMENT CLUSTER, AIR CONDITIONER CONTROL MODULE, HV PTC (Positive Temperature Coefficient) HEATER UNIT (PHEV (Plug-in Hybrid Electric Vehicle))
IBU 1	10A	IBU(INTEGRATED BODY CONTROL UNIT), SPORT MODE SWITCH
SUNROOF	20A	Sunroof Controller (Blind Motor)
E-SHIFTER 3	10A	SCU (Shift by wire Control Unit), Electronic Dual clutch transmission Shifter Dial Switch
S/HEATER FRT	20A	Front Air Ventilation Seat Control Module, Front Seat Warmer Control Module
WASHER	15A	Multifunction Switch
IBU 2	7.5A	IBU (Integrated Body Control Unit), Ignition Switch
E-SHIFTER 4	10A	SCU (Shift by wire Control Unit), Electronic Dual clutch transmission Shifter Dial Switch (PHEV (Plug-in Hybrid Electric Vehicle))
IG3 3	10A	ON BOARD CHARGER UNIT, HPCU (Hybrid Power Control Unit), Engine Room Junction Block (BATTERY C/FAN Relay), A/C COMPRESSOR
BATTERY MANAGEMENT	10A	Battery Management System
AIR BAG 2	10A	SRS (Supplemental Restraint System) Control Module
P/WINDOW LH	25A	Power Window Main Switch
E-SHIFTER 2	10A	SCU (Shift by wire Control Unit), Console Switch
MODULE 4	10A	IBU (Integrated Body Control Unit), ADAS PARKING ECU, VESS (Virtual Engine Sound System) UNIT, FRONT VIEW CAMERA, CRASH PAD SWITCH, CENTER CONSOL, REAR CORNER RADAR
MEMORY	10A	INSTRUMENT CLUSTER, HEAD UP DISPLAY, MOOD LAMP, AIR CONDITIONER CONTROL MODULE
FUEL LID	10A	Opening the fuel filler door (PHEV)
AMP	30A	AMP (Amplifier)
P/WINDOW RH	25A	Power Window Main Switch, Passenger Power Switch
MODULE 6	7.5A	IBU (INTEGRATED BODY CONTROL UNIT)
MODULE 5	10A	HEAD LAMP LEVELING DEVICE, AUDIO/ NAVIGATION HEAD UNIT, WIRELESS SMART PHONE CHARGING SYSTEM, E-CALL UNIT, AIR CONDITIONER CONTROL MODULE, OVERHEAD CONSOLE LAMP, ELECTRIC CHROMIC MIRROR, AMP(AMPLIFIER),SEAT WARMER CONTROL MODULE
MDPS 2	7.5A	Motor Driven Power Steering Unit
USB CHARGER	10A	USB CHARGER (FRONT TRAY/ SEAT Driver/ Passenger)
IAU	10A	DIGITAL KEY 2 TOUCH UNIT
BRAKE SWITCH	10A	IBU (Integrated Body Control Unit), Stop Lamp Switch
P/SEAT DRV	30A	Driver Power Seat Switch, Driver IMS (Integrated memory system) Control Module
A/C	7.5A	AIR CONDITIONER CONTROL MODULE, Engine Room Junction Block (BLOWER,PTC (Positive Temperature Coefficient) RELAY), A/C COMPRESSOR
AIR BAG 1	15A	SRS (Supplemental Restraint System) Control Module
IG1 2	25A	Engine Room Junction Block (PCB (Printed Circuit Board) BLOCK FUSE - IEB4, ECU3, DCT3, EWP3)
MODULE 2	10A	IBU (Integrated Body Control Unit), ADAS PARKING ECU, E-CALL, AUDIO/ NAVIGATION HEAD UNIT, Engine Room Junction Block (P/OUTLET Relay)
MULTI MEDIA	25A	Audio (Display), Audio/Video & Navigation Head Unit
DOOR LOCK	20A	Center Door Lock lock Relay

Fuse Name	Fuse Rating	Circuit Protected
MODULE 1	10A	KEY INTERLOCK, AIR CONDITIONER CONTROL MODULE, CHARGING LAMP (THE PLUG-IN HYBRID VEHICLE), HAZARD SWITCH, RAIN SENSOR, STEERING WHEEL REMOTE CONTROL
P/SEAT PASS	30A	Passenger Power Seat Switch, Passenger Seat Relay Unit
S/HEATER RR	25A	Rear Seat Warmer Control Module
MODULE 7	7.5A	ADAS PARKING ECU, AC INVERTER, COOLING FAN MOTOR, SEAT WARMER CONTROL MODULE
E-SHIFTER 2	10A	SCU (System Control Unit), Electronic Shift Dial
MODULE 4	10A	IBU (Integrated Body Control Unit), ADAS PARKING ECU, VESS (Virtual Engine Sound System) UNIT, FRONT VIEW CAMERA, CRASH PAD SWITCH, CENTER CONSOL, REAR CORNER RADAR





## Engine Room Junction Block

Fuse Name		Fuse Rating	Circuit Protected
MULTI FUSE-1	MDPS 1	80A	Motor Driven Power Steering Unit
MULTI FUSE-2	B+1	60A	ICU JUNCTION BLOCK (IPS)
	COOLING FAN	60A	Cooling Fan Controller
	IEB1	60A	IEB (Integrated Electronic Brake Module)
	B+5	60A	Engine Room PCB (Printed Circuit Board) Junction Block
	IEB3	60A	IEB (Integrated Electric Brake Module)
	B+3	50A	ICU JUNCTION BLOCK (FUSE - E-SHIFTER3, P/WDW LH, P/WDW RH, T/GATE OPEN, AMP (Amplifier), POWER SEAT Driver, POWER SEAT Passenger, SEAT HEATER Front, SEAT HEATER Rear), EWP2
	E-SHIFTER1	40A	SCU (Shift by wire Control Unit)
	BLOWER	40A	Blower Relay
	IG2	40A	ICU JUNCTION BLOCK (FUSE - WASHER, A/C, MODULE6, MODULE7, WIPER Rear)
	IG1 1	40A	ICU JUNCTION BLOCK (FUSE -MODULE2, USB CHARGER, A/BAG1, IBU2, MDPS2, CLUSTER, MODULE3, A/BAG Indicator, MODULE4, MODULE5, E-SHIFTER2, Forward Collision-Avoidance Assist, ING1 2)
MULTI FUSE-3	B+2	60A	ICU JUNCTION BLOCK (IPS)
	PTC HEATER1	50A	PTC (Positive Temperature Coefficient) HEATER #1 RELAY
	PTC HEATER2	50A	PTC (Positive Temperature Coefficient) HEATER #2 RELAY
	REAR HEATED	40A	Rear Heated Relay
	POWER TAILGATE	40A	Power Liftgate Unit
	DCT1	40A	DUAL CLUTCH TRANSMISSION
	DCT2	40A	DUAL CLUTCH TRANSMISSION
FUSE	B+4	40A	ICU JUNCTION BLOCK (FUSE - MULTIMEDIA, E-CALL, A/BAG2, BRAKE SWITCH, MODULE1, FUEL LID, IBU1, SUNROOF, BATTERY MANAGEMENT, DOOR LOCK
FUSE	HPCU	15A	HYBRID POWER CONTROL UNIT
FUSE	IG3 1	20A	IGNITION3 RELAY
FUSE	FUEL PUMP	20A	Fuel Pump Relay
FUSE	POWER OUTLET	20A	Front Power Outlet
FUSE	EWP1	10A	Battery Electronic Water Pump
FUSE	EWP2	10A	Battery Electronic Water Pump
FUSE	IEB2	40A	IEB (Integrated Electric Brake Module)
FUSE	CLUTCH ACTUATOR	30A	ENGINE CLUTCH ACTUATOR (HPCU (Hybrid Power Control Unit))
FUSE	INVERTER	40A	AC INVERTER
FUSE	POWER OUTLET1	40A	Front Power Outlet
FUSE	BATTERY C/FAN	15A	Battery Cooling Fan (HEV (Hybrid Electric Vehicle))
FUSE	AMS	10A	BATTERY SENSOR(PHEV (Plug-in Hybrid Electric Vehicle))
FUSE	EWP4	10A	Battery Electronic Water Pump (PHEV (Plug-in Hybrid Electric Vehicle))

## PCB Block

Fuse Name	Fuse Rating	Circuit Protected
WIPER FRT1	25A	FRONT WIPER MOTOR
OBC	10A	ON BOARD CHARGER UNIT(PHEV (Plug-in Hybrid Electric Vehicle))
SENSOR3	10A	FUEL PUMP RELAY
SENSOR2	10A	OIL CONTROL VALVE, , PURGE CONTROL SOLENOID VALVE, VARIABLE OIL PUMP VALVE CONTROL, COOLING FAN MOTOR RELAY,FUEL TANK ISOLATION VALVE(PHEV (Plug-in Hybrid Electric Vehicle))
SENSOR1	15A	Oxygen Sensor (UP/DOWN)
IGN COIL	20A	Ignition coil #1/#2/#3/#4
ECU1	20A	ECM (ENGINE CONTROL MODULE)
ECU2	15A	ECM (ENGINE CONTROL MODULE)
CHARGER	10A	CHARGER LOCK/UNLOCK RELAY(PHEV)
ECU3	10A	ECM (ENGINE CONTROL MODULE)
IEB4	10A	IEB (Integrated Electric Brake Module)
EWP3	10A	Battery Electronic Water Pump
DCT3	15A	DUAL CLUTCH TRANSMISSION

## Relay

Refer to the following table for the relay type.

Relay Name	TYPE
PDM (IG1)	MICRO
PDM (ACC)	MICRO
PDM (IG2)	MICRO
IG3	MICRO
FUEL PUMP	MICRO
BATTERY C/FAN	MICRO
BLOWER	MICRO
PTC HEATER1	MICRO
PTC HEATER2	MICRO
POWER OUTLET	MICRO
WIPER RR	MICRO
REAR HEATED	MINI
COOLING FAN	MINI

### Engine compartment fuse panel (Battery terminal cover) (For Plug-in Hybrid)



### \* NOTICE

Not all fuse panel descriptions in this manual may be applicable to your vehicle. It is accurate at the time of printing. When you inspect the fuse panel in your vehicle, refer to the fuse panel label.

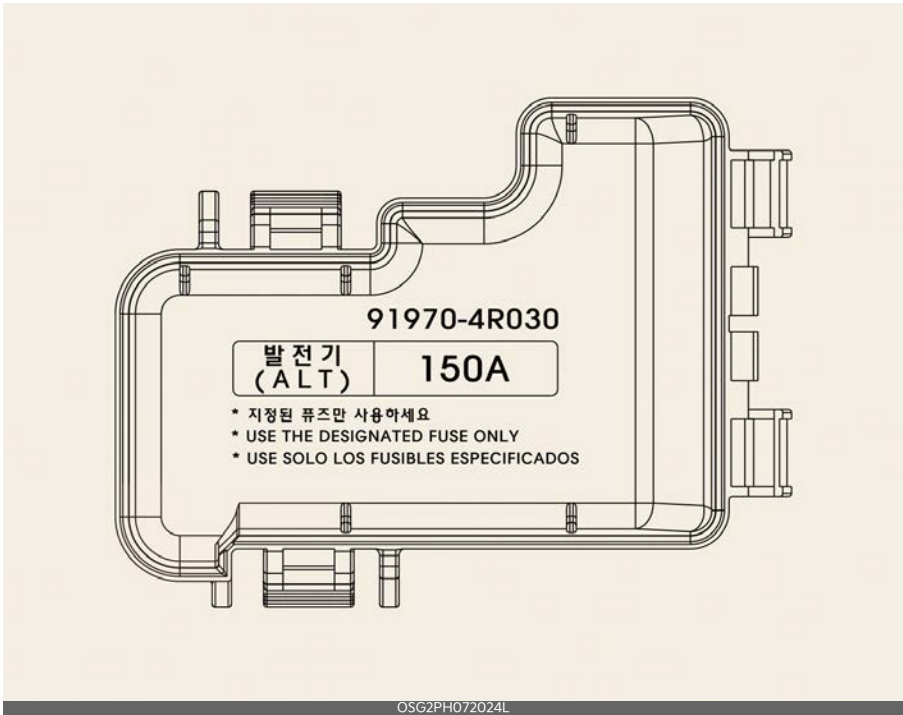

## Light bulbs

Light bulbs are installed in various parts of the vehicle to provide lighting inside and outside the vehicle as well as to alert other vehicles.

### Bulb replacement precaution

Please keep extra bulbs on hand with appropriate wattage ratings in case of emergencies.

Refer to "Bulb wattage" on page 9-4.

When changing lamps, first turn off the vehicle at a safe place, firmly apply the parking brake and disconnect the (-) battery terminal (For plug-in hybrid vehicle) or battery connector (For hybrid vehicle).

### ⚠ WARNING

#### Working on the lights

Prior to start working on the light system, firmly apply the parking brake, ensure that turn the ignition switch or ENGINE START/STOP button and turn off the lights to avoid sudden movement of the vehicle and burning your fingers or receiving an electric shock.

Use only bulbs of the specified wattage.

### ⚠ CAUTION

#### Light replacement

Be sure to replace the burned-out bulb with one of the same wattage rating. Otherwise, it may cause damage to the fuse or electric wiring system.

Fully install light bulbs and any parts used to secure them. Failure to do so may result in heat damage, fire, or water entering the headlamp unit. This may damage the headlamps or cause condensation to build up on the lens. To

prevent damage or fire, make sure bulbs are fully seated and locked.

### ⚠ CAUTION

#### Headlamp lens

To prevent damage, do not clean the headlamp lens with chemical solvents or strong detergents.

### \* NOTICE

- If the light bulb or lamp connector is removed while the lamp is still on, the fuse box's electronic system may log it as a malfunction. Therefore, a lamp malfunction incident may be recorded as a Diagnostic Trouble Code (DTC) in the fuse box.
- It is normal for an operating lamp to flicker momentarily. This is due to a stabilization function of the vehicle's electronic control device. If the lamp lights up normally after momentarily blinking, then it is functioning as normal.

However, if the lamp continues to flicker several times or turns off completely, there may be an error in the vehicle's electronic control device. Please have the vehicle checked by an authorized Kia dealer immediately.

### \* NOTICE

Have the headlamp aiming adjusted by an authorized Kia dealer after an accident or after the headlamp assembly is reinstalled.

### \* NOTICE

You can find moisture inside the lens of lamps after a car wash or driving in the rain. It is a natural event caused by the

temperature difference between the inside and the outside of the lamp and does not mean there is a problem with its functions. The moisture inside the lamp would disappear if you drive the vehicle with the headlamp turned on. However, the level at which the moisture is removed may differ depending on the size/location/condition of the lamp. If the moisture continues to stay inside the lamp, have the vehicle checked by an authorized Kia dealer.

If you don't have the necessary tools, the correct bulbs and the expertise, consult an authorized Kia dealer. In many cases, it is difficult to replace vehicle light bulbs because other parts of the vehicle must be removed before you can get to the bulb. This is especially true if you have to remove the headlamp assembly to get to the bulb(s).

Removing/installing the headlamp assembly can result in damage to the vehicle. If non-genuine parts or substandard bulbs are used, it may lead to blowing a fuse or other wiring damages. Kia Genuine Parts we guarantee for quality and performance.

Do not install extra lamps or LEDs to the vehicle. If additional lights are installed, it may lead to lamp malfunctions and flickering. Additionally, the fuse box and other wiring may be damaged.

### Light bulb position (Front)

Headlamp - Type A



Headlamp - Type B



Fog lamp



- 1 Headlamp (Low) (LED type)
- 2 Headlamp (Low/High) (Bulb type)
- 3 Headlamp (Low/High) (LED type)
- 4 Day time running lamp/Position lamp/  
Front turn signal lamp (LED type)
- 5 Front fog lamp (LED type)
- 6 Front side marker lamp (LED type)

### Light bulb position (Rear)

Rear combination lamp - Type A



Rear combination lamp - Type B



- 1 Rear turn signal lamp (Bulb type)
- 2 Backup lamp (Bulb type)
- 3 Rear turn signal lamp (LED type)
- 4 Backup lamp (LED type)
- 5 Tail lamp/Stop lamp (LED type)
- 6 High mounted stop lamp (LED type)
- 7 License plate lamp (Bulb type)
- 8 Rear side marker (LED type)

Light position (Side)



- 1 Side repeater lamp (LED type)

Replacing lights (LED type)

If the LED lamp does not operate, have your vehicle checked by an authorized Kia dealer. The LED lamp cannot be replaced as a single component because it is an integrated unit. The LED lamp has to be replaced with the unit.

A skilled technician should check or repair the LED lamp, for it may damage related parts of the vehicle.

Replacing headlamp (Low beam/ High beam) (Bulb type)

Operation

1. Before turning off the vehicle, operate the steering wheel in the opposite direction of the lamp to be replaced to steer the tires toward the inside of the vehicle body.
  - When replacing the right headlamp: operate to the left
  - When replacing the left headlamp: operate to the right
2. Turn off vehicle and disconnect the (-) battery terminal (For plug-in hybrid vehicle) or battery connector (For hybrid vehicle).
3. Remove the wheel guard fasteners using a tool and then remove the wheel guard.



4. Remove the socket from the assembly (1) by turning the socket counter-clockwise until the tabs on the socket align with the slots on the assembly



5. Remove the bulb from the socket by pressing it in and rotating it counter-clockwise until the tabs on the bulb align with the slots in the socket. Pull the bulb out of the socket.

6. Insert a new bulb by inserting it into the socket and rotating it until it locks into place
7. Install the socket in the assembly by aligning the tabs on the socket with the slots in the assembly. Push the socket into the assembly and turn the socket clockwise
8. Connect the (-) battery terminal (For plug-in hybrid vehicle) or battery connector (For hybrid vehicle).

## Headlamp bulb



### **⚠ WARNING**

## Halogen bulbs

- Halogen bulbs contain pressurized gas that will produce flying pieces of glass if broken.
- Always handle them carefully, and avoid scratches and abrasions. If the bulbs are lit, avoid contact with liquids. Never touch the glass with bare hands. Residual oil may cause the bulb to overheat and burst when lit. A bulb should be operated only when installed in a headlight.
- If a bulb becomes damaged or cracked, replace it immediately and carefully dispose of it.
- Wear eye protection when changing a bulb. Allow the bulb to cool down before handling it.

## Replacing rear turn signal lamp, backup lamp (Bulb type)

If the rear turn signal lamp or backup lamp does not operate, have your vehicle checked by a professional workshop. A skilled technician should check or repair the lamps, for it may damage related parts of the vehicle.

## Replacing high mounted stop lamp (LED type)



If the high mounted stop lamp (LED) does not operate, have your vehicle checked by an authorized Kia dealer.

The LED lamp cannot be replaced as a single unit because it is an integrated unit. The LED lamp has to be replaced with the unit.

A skilled technician should check or repair the high mounted stop lamp (LED), for it may damage related parts of the vehicle.

## Replacing license plate lamp (Bulb type)

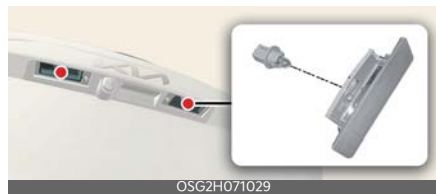

1. Turn off vehicle and disconnect the (-) battery terminal (For plug-in hybrid vehicle) or battery connector (For hybrid vehicle).



- Using a flat-blade screwdriver, gently pry the lens cover from lamp housing.
- Remove the bulb by pulling it straight out.
- Install a new bulb in the socket.
- Align the lens cover tabs with the lamp housing notches and snap the lens into place.

### Replacing map lamp (Bulb type)



#### **⚠ WARNING**

#### Interior lamps

Prior to working on the Interior lamps, ensure that the "OFF" button is depressed to avoid burning your fingers or receiving an electric shock.

- Turn off vehicle and disconnect the (-) battery terminal (For plug-in hybrid vehicle) or battery connector (For hybrid vehicle).
- Using a flat-blade screwdriver, gently pry the lens cover from lamp housing.
- Remove the bulb by pulling it straight out.
- Install a new bulb in the socket.
- Align the lens cover tabs with the lamp housing notches and snap the lens into place.

#### **⚠ CAUTION**

Be careful not to dirty or damage the lens, lens tab, and plastic housings.

### Replacing room lamp (Bulb type)



#### **⚠ WARNING**

#### Interior lamps

Prior to working on the Interior lamps, ensure that the "OFF" button is depressed to avoid burning your fingers or receiving an electric shock.

- Turn off vehicle and disconnect the (-) battery terminal (For plug-in hybrid vehicle) or battery connector (For hybrid vehicle).
- Using a flat-blade screwdriver, gently pry the lens cover from lamp housing.
- Remove the bulb by pulling it straight out.
- Install a new bulb in the socket.
- Align the lens cover tabs with the lamp housing notches and snap the lens into place.

#### **⚠ CAUTION**

Be careful not to dirty or damage the lens, lens tab, and plastic housings.

## Replacing vanity mirror lamp (Bulb type)



### ⚠ WARNING

#### Interior lamps

Prior to working on the Interior lamps, ensure that the "OFF" button is depressed to avoid burning your fingers or receiving an electric shock.

1. Turn off vehicle and disconnect the (-) battery terminal (For plug-in hybrid vehicle) or battery connector (For hybrid vehicle).
2. Using a flat-blade screwdriver, gently pry the lamp assembly from interior.
3. Remove the bulb by pulling it straight out.
4. Install a new bulb in the socket.
5. Install the lamp assembly to interior.

### ⚠ CAUTION

Be careful not to dirty or damage the lens, lens tab, and plastic housings.

## Replacing glove box lamp (Bulb type)

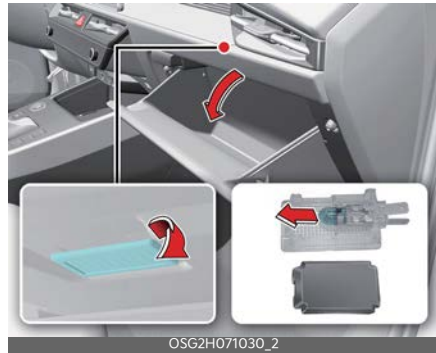

### ⚠ WARNING

#### Interior lamps

Prior to working on the Interior lamps, ensure that the "OFF" button is depressed to avoid burning your fingers or receiving an electric shock.

1. Turn off vehicle and disconnect the (-) battery terminal (For plug-in hybrid vehicle) or battery connector (For hybrid vehicle).
2. Using a flat-blade screwdriver, gently pry the lamp assembly from interior.
3. Remove the cover from the lamp assembly.
4. Remove the bulb by pulling it straight out.
5. Install a new bulb in the socket.
6. Install the cover to the lamp assembly.
7. Install the lamp assembly to interior.

### ⚠ CAUTION

Be careful not to dirty or damage the lens, lens tab, and plastic housings.

## Replacing luggage lamp (Bulb type)



### ⚠ WARNING

#### Interior lamps

Prior to working on the Interior lamps, ensure that the "OFF" button is depressed to avoid burning your fingers or receiving an electric shock.

1. Turn off vehicle and disconnect the (-) battery terminal (For plug-in hybrid vehicle) or battery connector (For hybrid vehicle).
2. Using a flat-blade screwdriver, gently pry the lamp assembly from interior.
3. Remove the cover from the lamp assembly.
4. Remove the bulb by pulling it straight out.
5. Install a new bulb in the socket.
6. Install the cover to the lamp assembly.
7. Install the lamp assembly to interior.

### ⚠ CAUTION

Be careful not to dirty or damage the lens, lens tab, and plastic housings.

## Appearance care

Use the information in the following sections to keep the exterior and interior of your vehicle clean.

### Exterior care

Use the information in the following sections to maintain the exterior of your vehicle. Keeping the exterior clean is not only aesthetically pleasing, but it also helps to prolong the life of the vehicle.

### \* NOTICE

If you park the vehicle around a stainless signboard or windshield building etc., the plastic exterior trim (bumper, spoiler, garnish, lamp, outside mirror etc.) may be damaged by reflected sunlight from the external structure. To avoid damaging the plastic exterior trim, park the vehicle away from the areas where the reflected light may occur or use a vehicle cover. (Depending on the vehicle, the type of exterior trim applied such as spoiler may differ.)

### Exterior general caution

It is very important to follow the label directions when using any chemical cleaner or polish. Read all warning and caution statements that appear on the label.

## Finish maintenance

### Washing

To help protect your vehicle's finish from rust and deterioration, wash it thoroughly and frequently at least once a month with lukewarm or cold water.

If you use your vehicle for off-road driving, you should wash it after each off-road trip. Pay special attention to the removal of any accumulation of salt, dirt, mud, and other foreign materials. Make sure the drain holes in the lower edges of the doors and rocker panels are kept clear and clean.

Insects, tar, tree sap, bird droppings, industrial pollution and similar deposits can damage your vehicle's finish if not removed immediately.

Even prompt washing with plain water may not completely remove all these deposits. A mild soap, safe for use on painted surfaces, may be used.

After washing, rinse the vehicle thoroughly with lukewarm or cold water. Do not allow soap to dry on the finish.

After washing the vehicle, test the brakes while driving slowly to see if they have been affected by water. If braking performance is impaired, dry the brakes by applying them lightly while maintaining a slow forward speed.

### CAUTION

- Do not use strong soap, chemical detergents or hot water, and do not wash the vehicle in direct sunlight or when the body of the vehicle is warm.
- Be careful when washing the side windows of your vehicle, especially with high-pressure water. Water may leak through the windows and wet the interior.

- To prevent damage to the plastic parts and lamps, do not clean with chemical solvents or strong detergents.

### WARNING

After washing the vehicle, test the brakes while driving slowly to see if they have been affected by water. If braking performance is impaired, dry the brakes by applying them lightly while maintaining a slow forward speed.

### High-pressure washing

When using high-pressure washers, make sure to maintain sufficient distance from the vehicle.

Insufficient clearance or excessive pressure can lead to component damage or water penetration.

Do not spray the camera, sensors or its surrounding area directly with a high pressure washer. Shock applied from high pressure water may cause the device to not operate normally.

Do not bring the nozzle tip close to boots (rubber or plastic covers) or connectors as they may be damaged if they come into contact with high pressure water.

### WARNING

After washing the vehicle, test the brakes while driving slowly to see if they have been affected by water. If braking performance is impaired, dry the brakes by applying them lightly while maintaining a slow forward speed.

**⚠ CAUTION****Wetting engine compartment**

- Water washing in the engine compartment including high pressure water washing may cause the failure of electrical circuits located in the engine compartment.
- Never allow water or other liquids to come in contact with electrical/electronic components and air duct inside the vehicle as this may damage them.
- After the vehicle has been washed, brake carefully while paying attention to the traffic conditions until the braking effect has been fully restored.

**Waxing**

Wax the vehicle when water will no longer bead on the paint.

Always wash and dry the vehicle before waxing. Use a good quality liquid or paste wax, and follow the manufacturer's instructions. Wax all metal trim to protect it and to maintain its luster.

Removing oil, tar, and similar materials with a spot remover will usually strip the wax from the finish. Be sure to re-wax these areas even if the rest of the vehicle does not yet need waxing.

Be careful not to touch the lens when waxing the lamps.

**⚠ CAUTION****Drying vehicle**

- Wiping dust or dirt off the body with a dry cloth will scratch the finish.
- Do not use steel wool, abrasive cleaners, acid detergents or strong detergents containing high alkaline or caustic agents on chrome-plated or anodized aluminum parts. This may result in damage to the protective coating and cause discoloration or paint deterioration.

**Finish damage repair**

Deep scratches or stone chips in the painted surface must be repaired promptly. Exposed metal will quickly rust and may develop into a major repair expense.

**\* NOTICE**

If your vehicle is damaged and requires any metal repair or replacement, be sure the body shop applies anti-corrosion materials to the parts repaired or replaced.

**Bright-metal maintenance**

To remove road tar and insects, use a tar remover, not a scraper or other sharp object.

To protect the surfaces of bright metal parts from corrosion, apply a coating of wax or chrome preservative and rub to a high luster.

During winter weather or in coastal areas, cover the bright metal parts with a heavier coating of wax or preservative. If necessary, coat the parts with non-cor-

rosive petroleum jelly or other protective compound.

### Underbody maintenance

Road salt and other corrosive chemicals are used in cold weather states to melt snow and prevent ice accumulation. If these chemicals are not regularly removed, they will corrode the vehicle underbody and, over time, damage many parts: the fuel lines, the fuel tank retention system, the vehicle's suspension, the exhaust system, and even the body frame.

### Aluminum wheel maintenance

The aluminum wheels are coated with a clear protective finish.

- Do not use any abrasive cleaner, polishing compound, solvent, or wire brushes on aluminum wheels. They may scratch or damage the finish.
- Clean the wheel when it has cooled.
- Use only a mild soap or neutral detergent, and rinse thoroughly with water. Also, be sure to clean the wheels after driving on salted roads. This helps prevent corrosion.
- Avoid washing the wheels with high speed vehicle wash brushes.
- Do not use any alkaline or acid detergents. It may damage and corrode the aluminum wheels coated with a clear protective finish.

## Corrosion protection

### Protecting your vehicle from corrosion

By using the most advanced design and construction practices to combat corro-

sion, we produce vehicles of the highest quality. However, this is only part of the job. To achieve the long-term corrosion resistance your vehicle can deliver, the owner's cooperation and assistance is also required.

### Common causes of corrosion

The most common causes of corrosion on your vehicle are:

- Road salt, dirt and moisture that is allowed to accumulate underneath the vehicle.
- Removal of paint or protective coatings by stones, gravel, abrasion or minor scrapes and dents which leave unprotected metal exposed to corrosion.

### High-corrosion areas

If you live in an area where your vehicle is regularly exposed to corrosive materials, corrosion protection is particularly important. Some of the common causes of accelerated corrosion are road salts, dust control chemicals, ocean air and industrial pollution.

### Moisture breeds corrosion

Moisture creates the conditions in which corrosion is most likely to occur. For example, corrosion is accelerated by high humidity, particularly when temperatures are just above freezing. In such conditions, the corrosive material is kept in contact with the vehicle's surface by moisture that evaporates slowly.

Mud is particularly corrosive because it dries slowly and holds moisture in contact with the vehicle. Although the mud appears to be dry, it can still retain the moisture and promote corrosion.

High temperatures can also accelerate corrosion of parts that are not properly ventilated so the moisture can be dispersed. For all these reasons, it is particularly important to keep your vehicle clean and free of mud or accumulations of other materials. This applies not only to the visible surfaces but particularly to the underside of the vehicle.

### To help prevent corrosion

You can help prevent corrosion from beginning by observing the following:

#### Keep your vehicle clean

The best way to prevent corrosion is to keep your vehicle clean and free of corrosive materials. Attention to the underside of the vehicle is particularly important.

If you live in a high-corrosion area where road salts are used, near the ocean, areas with industrial pollution, acid rain, etc.—, you should take extra care to prevent corrosion. In winter, hose off the underside of your vehicle at least once a month and be sure to clean the underside thoroughly when winter is over.

When cleaning underneath the vehicle, give particular attention to the components under the fenders and other areas that are hidden from view. Do a thorough job; just dampening the accumulated mud rather than washing it away will accelerate corrosion rather than prevent it. Water under high pressure and steam are particularly effective in removing accumulated mud and corrosive materials.

When cleaning lower door panels, rocker panels and frame members, be sure that drain holes are kept open so that mois-

ture can escape and not be trapped inside to accelerate corrosion.

#### Keep your garage dry

Don't park your vehicle in a damp, poorly ventilated garage. This creates a favorable environment for corrosion. This is particularly true if you wash your vehicle in the garage or drive it into the garage when it is still wet or covered with snow, ice or mud. Even a heated garage can contribute to corrosion unless it is well ventilated so moisture is dispersed.

#### Keep paint and trim in good condition

Scratches or chips in the finish should be covered with "touch-up" paint as soon as possible to reduce the possibility of corrosion. If bare metal is showing through, the attention of a qualified body and paint shop is recommended.

Bird droppings: Bird droppings are highly corrosive and may damage painted surfaces in just a few hours. Always remove bird droppings as soon as possible.

#### Don't neglect the interior

Moisture can collect under the floor mats and carpeting and cause corrosion. Check under the mats periodically to be sure the carpeting is dry. Use particular care if you carry fertilizers, cleaning materials or chemicals in the vehicle.

These should be carried only in proper containers and any spills or leaks should be cleaned up, flushed with clean water and thoroughly dried.

## Interior care

Use the information in the following sections to maintain the interior of your vehicle.

## Interior general precautions

Prevent chemicals such as perfume, cosmetic oil, sun cream, hand cleaner, and air freshener from contacting the interior parts because they may cause damage or discoloration. If they do contact the interior parts, wipe them off immediately. If necessary, use a mixture of warm water and mild non-detergent cleaner (test all cleaners on a concealed area before use). Use proper car cleaner to clean interior parts.

### ⚠ CAUTION

## Electrical components

Never allow water or other liquids to come in contact with electrical/electronic components inside the vehicle as this may damage them.

### ⚠ CAUTION

## Leather

When cleaning leather products (steering wheel, seats etc.), use neutral detergents or low alcohol content solutions. If you use high alcohol content solutions or acid/alkaline detergents, the color of the leather may fade or the surface may get stripped off.

## Taking care of leather seats

- Vacuum the seat periodically to remove dust and sand on the seat. It will prevent abrasion or damage of the leather and maintain its quality.
- Wipe the leather seat cover often with dry or soft cloth.
- Sufficient use of a leather protective may prevent abrasion of the cover and helps maintain the color. Be sure to read the instructions and consult a specialist when using leather coating or protective agents.
- Leather with bright colors (beige, cream beige) is easily contaminated and clear in appearance. Clean the seats frequently.
- Avoid wiping with wet cloth. It may cause the surface to crack.

## Cleaning the leather seats

Remove all contaminations instantly. Refer to instructions below for removal of each contaminant.

- Cosmetic products (sunscreen, foundation, etc.)
  - Apply cleansing cream on a cloth and wipe the contaminated point. Wipe off the cream with a wet cloth and remove water with a dry cloth.
- Beverages (coffee, soft drink, etc.)
  - Apply a small amount of neutral detergent and wipe until contaminations do not smear.
- Oil, blue jeans/clothes (Color transfer)
  - Remove oil/stain instantly with absorbable cloth and wipe with stain remover for leather only.
- Chewing gum
  - Harden the gum with ice and remove gradually.

## Fabric seat cover (if equipped)

Please clean the fabric seats regularly with a vacuum cleaner in consideration of fabric material characteristics. If they



are heavily soiled with beverage stains, etc., use a suitable interior cleaner. To prevent damage to seat covers, wipe off the seat covers down to the seams with a large wiping motion and moderate pressure using a soft sponge or microfiber cloth.

Velcro closures on clothing or sharp objects may cause snagging or scratches on the surface of the seats. Make sure not to rub such objects against the surface.

## Cleaning the upholstery and interior trim

### Car interior surfaces

Remove dust and loose dirt from interior surfaces with a whisk broom or a vacuum cleaner. If necessary, clean interior surfaces with a mixture of warm water and mild non-detergent cleaner (test all cleaners on a concealed area before use).

### Fabric

Remove dust and loose dirt from fabric with a whisk broom or vacuum cleaner. Clean with a mild soap solution recommended for upholstery or carpets. Remove fresh spots immediately with a fabric spot cleaner. If fresh spots do not receive immediate attention, the fabric can be stained and its color can be affected. Also, its fire-resistant properties can be reduced if the material is not properly maintained.

Using anything but recommended cleaners and procedures may affect the fabric's appearance and fire-resistant properties.

## Cleaning the lap/shoulder belt webbing

Clean the belt webbing with any mild soap solution recommended for cleaning upholstery or carpet. Follow the instructions provided with the soap. Do not bleach or re-dye the webbing because this may weaken it.

## Cleaning the interior window glass

If the interior glass surfaces of the vehicle become fogged (that is, covered with an oily, greasy or waxy film), they should be cleaned with a glass cleaner. Follow the directions on the glass cleaner container.

### CAUTION

#### Rear window

Do not scrape or scratch the inside of the rear window. This may result in damage of the rear window defroster grid.

## Emission control system

The emission control system of your vehicle is covered by a written limited warranty. Please see the warranty information contained in the Warranty & Consumer Information manual in your vehicle.

Your vehicle is equipped with an emission control system to meet all applicable emission regulations. There are three emission control systems, as follows.

1. Crankcase emission control system
2. Evaporative emission control system
3. Exhaust emission control system

In order to assure the proper function of the emission control systems, it is recommended that you have your vehicle inspected and maintained by an authorized Kia dealer in accordance with the maintenance schedule in this manual.

### Caution for the Inspection and Maintenance Test (With Electronic Stability Control (ESC) system)

- **To prevent the vehicle from misfiring during dynamometer testing, turn the ESC off by pressing the ESC switch.**
- **After dynamometer testing is completed, turn the ESC back on by pressing the ESC switch again.**

### 1. Crankcase emission control system

The Positive Crankcase Ventilation system is employed to prevent air pollution caused by blow-by gases being emitted from the crankcase. This system supplies fresh filtered air to the crankcase through the air intake hose. Inside the

crankcase, the fresh air mixes with blow-by gases, which then pass through the Positive Crankcase Ventilation (PCV) valve into the induction system.

### 2. Evaporative emission control (including Onboard Refueling Vapor Recovery (ORVR)) system

The evaporative emission control system is designed to prevent fuel vapors from escaping into the atmosphere. (The ORVR system is designed to allow the vapors from the fuel tank to be loaded into a canister while refueling at the gas station, preventing the escape of fuel vapors into the atmosphere.)

#### Canister

Fuel vapors generated inside the fuel tank are absorbed and stored in the onboard canister. When the engine is running, the fuel vapors absorbed in the canister are drawn into the surge tank through the Purge Control Solenoid Valve.

#### Purge Control Solenoid Valve (PCSV)

The Purge Control Solenoid Valve (PCSV) is controlled by the Engine Control Module (ECM); when the engine coolant temperature is low during idling, the PCSV closes so that evaporated fuel is not taken into the engine. After the engine warms up during ordinary driving, the PCSV opens to introduce evaporated fuel to the engine.

### 3. Exhaust emission control system

The exhaust emission control system is a highly effective system which controls exhaust emissions while maintaining good vehicle performance.

#### Vehicle modifications

This vehicle should not be modified. Modification of your vehicle could affect its performance, safety or durability and may even violate governmental safety and emissions regulations.

#### \* NOTICE

In addition, damage or performance problems resulting from any modification may not be covered under warranty.

#### ⚠ CAUTION

If you use authorized electronic devices, it may cause the vehicle to operate abnormally, wire damage, battery discharge and fire. For your safety, do not use unauthorized electronic devices.

#### Engine exhaust gas precautions (carbon monoxide)

- Carbon monoxide can be present with other exhaust fumes. Therefore, if you smell exhaust fumes of any kind inside your vehicle, have it inspected and repaired immediately. If you ever suspect exhaust fumes are coming into your vehicle, drive it only with all the windows fully open. Have your vehicle checked and repaired immediately.

#### ⚠ WARNING

##### Exhaust

Engine exhaust gases contain carbon monoxide (CO). Though colorless and odorless, it is dangerous and could be lethal if inhaled. Follow the instructions on this page to avoid CO poisoning.

- Do not operate the engine in confined or closed areas (such as garages) any more than what is necessary to move the vehicle in or out of the area.
- When the vehicle is stopped in an open area for more than a short time with the engine running, adjust the ventilation system (as needed) to draw outside air into the vehicle.
- Never sit in a parked or stopped vehicle for any extended time with the engine running.
- When the engine stalls or fails to start, excessive attempts to restart the engine may cause damage to the emission control system.

#### ⚠ WARNING

##### Catalytic converter

Keep away from the catalytic converter and exhaust system while the vehicle is running or immediately thereafter. The exhaust and catalytic systems are very hot and may burn you.

## Operating precautions for catalytic converters

### **WARNING**

#### Fire

- Do not park, idle or drive the vehicle over or near flammable objects, such as grass, vegetation, paper, leaves, etc. A hot exhaust system can ignite flammable items under your vehicle.
- Also, do not remove the heat sink around the exhaust system, do not seal the bottom of the vehicle or do not coat the vehicle for corrosion control. It may present a fire risk under certain conditions.

Your vehicle is equipped with a catalytic converter emission control device.

Therefore, the following precautions must be observed:

- Use only UNLEADED FUEL for gasoline engines.
- Do not operate the vehicle when there are signs of engine malfunction, such as misfire or a noticeable loss of performance.
- Do not misuse or abuse the engine. Examples of misuse are coasting with the ignition off and descending steep grades in gear with the ignition off.
- Do not operate the engine at high idle speed for extended periods (5 minutes or more).
- Do not modify or tamper with any part of the engine or emission control system. All inspections and adjustments must be made by an authorized Kia dealer.

- Avoid driving with an extremely low fuel level. Running out of fuel could cause the engine to misfire, damaging the catalytic converter.

Failure to observe these precautions could result in damage to the catalytic converter and to your vehicle. Additionally, such actions could void your warranties.

### **Procedure for entering forced engine activation mode**

If the engine needs to be kept running while the vehicle is stopped to inspect emission gas or perform vehicle maintenance, follow below procedure to enter forced engine activation mode.

1. Place the shift lever or dial in P (Park) position with the vehicle stopped. Engage the parking brake. Then, follow the steps (1) to (5).

Below steps from (1) to (5) must be completed within 60 seconds. If not, the process is reset and you must start again from step (1).

- 1) Turn the ignition switch to the ON position. Vehicles equipped with the smart key, press the ENGINE START/STOP button twice without depressing the brake pedal.
- 2) Place the shift lever or dial in P (Park) position and depress the accelerator pedal twice.
- 3) Place the shift lever or dial in N (Neutral) position and depress the accelerator pedal twice.
- 4) Place the shift lever or dial in P (Park) position and depress the accelerator pedal twice.
- 5) With the brake pedal depressed, start the engine, and maintain idling state. The engine remains in idle state and the forced engine

activation mode is maintained even when the gear is shifted to a different position.

2. **(READY)** indicator on the instrument cluster blinks when the vehicle is in forced engine activation mode. Check the **(READY)** indicator blinking to ensure that the forced engine activation mode is correctly entered.

The **(READY)** indicator continues blinking until the forced engine activation mode is canceled. When the mode is canceled the **(READY)** indicator will stop blinking.

3. To cancel the forced engine activation mode, turn the vehicle off.



# Specifications & Consumer information

Dimensions .....	9-2
Engine .....	9-2
Gross vehicle weight .....	9-3
Luggage volume .....	9-3
Air conditioning system.....	9-3
Bulb wattage .....	9-4
Tires and wheels .....	9-5
Recommended lubricants and capacities .....	9-6
• Recommended SAE viscosity number.....	9-7
Vehicle Identification Number (VIN).....	9-8
Vehicle certification label.....	9-8
Tire specification and pressure label.....	9-8
Engine number.....	9-8
Air conditioner compressor label .....	9-9
Reporting Safety Defects .....	9-9

## Specifications & Consumer information

### Dimensions

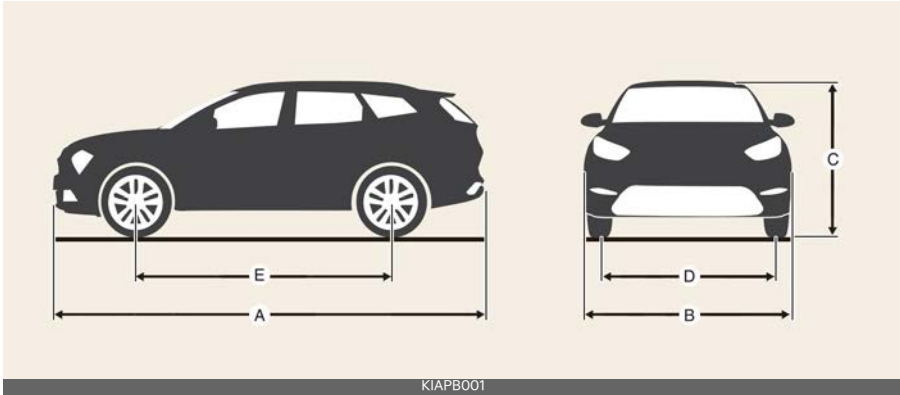

Item		mm (in)		
A	Vehicle overall length	4,420 (174.0)		
B	Vehicle overall width	1,825 (71.9)		
C	Overall height	1,545 (60.8)		
D	Tread	Front	205/60 R16	1,585 (62.4)
			225/45 R18	1,573(61.9)
		Rear	205/60 R16	1,596 (62.8)
			225/45 R18	1,585 (62.4)
E	Wheelbase	2,720 (107.1)		

### Engine

Item	Smartstream G1.6 GDI HEV/PHEV
Displacement [cc (cu in)]	1,580 (96.4)
Bore x Stroke [mm (in)]	72.0 x 97.0 (2.83 x 3.81)
Firing order	1-3-4-2
No. of cylinders	4 (inline)



## Gross vehicle weight

Item	Gross vehicle weight [kg (lbs.)]
Smartstream G1.6 GDi HEV	1,910 (4,211)
Smartstream G1.6 GDi PHEV	2,040 (4,497)

## Luggage volume

- Min: Behind rear seat
- Max: Behind front seat

Item		Volume	
Luggage volume (SAE) [L (cu ft)]	Smartstream G1.6 GDi HEV	MIN.	646 (22.9)
		MAX.	1,805 (63.7)
	Smartstream G1.6 GDi PHEV	MIN.	550 (19.4)
		MAX.	1,546 (54.6)

## Air conditioning system

Item		Weight of volume (g)	Classification
Refrigerant	HEV	450±25	R-1234yf
	PHEV	480±25	
Compressor lubricant		120±10	POE

Please contact a professional workshop for more details.

Contact an authorized Kia dealer.

## Bulb wattage

\*: if equipped

Light bulb	Bulb type	Wattage (Watt)	
Head lamp (Type A)	Head lamp (High/Low)	HB3	60
	Turn signal lamps	LED	LED
	Position and daytime running lamps	LED	LED
	Side marker	LED	LED
Head lamp (Type B)	Head lamp (High)	LED	LED
	Head lamp (High/Low)	LED	LED
	Turn signal lamps	LED	LED
	Position and daytime running lamps	LED	LED
	Side marker	LED	LED
Front and side	Front fog lamps	LED	LED
	Side repeater lamps	LED	LED
Rear combination lamp	Stop lamps	LED	LED
	Tail lamps	LED	LED
Rear lower combination lamp (Type A)	Turn signal lamps	PY21W	21
	Backup lamps	W16W	16
Rear lower combination lamp (Type B)	Turn signal lamps	LED	LED
	Backup lamps	LED	LED
Rear	High mounted stop lamp	LED	LED
	License plate lamps	W5W	5
	Side marker	LED	LED
Interior	Map lamps (Bulb type)	WEDGE(W10W)	10
	Map lamps (LED type)	LED	LED
	Room lamps (Bulb type)	FESTOON	10
	Room lamps (LED type)	LED	LED
	Vanity mirror lamps*	FESTOON	5
	Glove box lam	W5W	5
	Luggage lamp (Bulb type)	FESTOON	10
	Luggage lamp (LED type)	LED	LED
Ambient light	LED	LED	

\* : if equipped

## Tires and wheels

\*1. Load Index

\*2. Speed Symbol

Item	Tire size	Wheel size	Load capacity		Speed capacity		Inflation pressure [kPa (psi)]				Wheel lug nut torque kgf·m (lbf·ft, N·m)
			L <sup>*1</sup>	kg	SS <sup>*2</sup>	km/h	Normal load		Maximum load		
							Front	Rear	Front	Rear	
Full size tire	205/60 R16	6.5Jx16	92	630	H	210	250 (36)				11~13 (79~94, 107~127)
	225/45 R18	7.5Jx18	95	690	V	240					
Compact spare tire (steel wheel)	T125/80 D16	4Tx16	97	730	M	130	420 (60)				

### **⚠ CAUTION**

When replacing tires, use the same size originally supplied with the vehicle. Using tires of a different size can damage the related parts or make it work irregularly.

### **\* NOTICE**

- We recommend that when replacing tires, use the same originally supplied with the vehicles. If not, that affects driving performance.
- When driving in high altitude grades, it is natural for the atmospheric pressure to decrease. Therefore, please check the tire pressure and add more air when necessary. Additionally required tire air pressure per km above sea level: 10.5 kPa (1.5 psi)/km

## Recommended lubricants and capacities

To help achieve proper engine and powertrain performance and durability, use only lubricants of the proper quality.

The correct lubricants also help promote engine efficiency that results in improved fuel economy.

These lubricants and fluids are recommended for use in your vehicle.

Lubricant		Volume	Classification
Engine oil (drain and refill) <sup>1</sup> Recommends <b>Kia  TotalEnergies</b>	Smart stream G1.6 GDi HEV/PHEV	3.8L (4 US qt)	Full synthetic SAE 0W-16, API SN PLUS/SP or ILSAC GF-6
Dual clutch transmission (DCT) fluid <sup>2</sup>		1.6L ~ 1.7L (1.7 US qt ~ 1.8 US qt)	HK D DCTF TGO-10 PLUS (SK) SPIRAX S6 GHDE 70W DCTF PLUS (H-K SHELL) Kia genuine DCTF 70W SYNTHETIC PLUS
Coolant (Engine) <sup>3</sup>		6.7L (7.1 US qt)	An Phosphate based ethylene glycol based coolant
Coolant (Inverter) <sup>3</sup>	HEV	1.8 L (1.9 US qt)	An Phosphate based ethylene glycol based coolant
	PHEV	4.8 L (5.1 US qt)	Contact an authorized Kia dealer
Brake fluid		As required	SAE J1704 DOT-4 LV / FMVSS 116 DOT-4 / ISO4925 CLASS-6
Engine clutch actuator fluid		As required	SAE J1704 DOT-4 LV / FMVSS 116 DOT-4 / ISO4925 CLASS-6
Fuel	HEV	42 L (11.1 US gal)	Gasoline
	PHEV	37L (9.8 US gal)	

\*1. Refer to "Recommended SAE viscosity number" on page 9-7.

\*2. Use only specified genuine dual clutch transmission fluid. The use of non-specified (even marked as compatible with genuine) could result in shift quality deterioration and vibrations, eventually, the transmission failure. (Refer to "Explanation of scheduled maintenance items" on page 8-13.)

\*3. Different type of coolant or water may damage the electrical component.

## Recommended SAE viscosity number

Temperature Range for SAE Viscosity Numbers										
Temperature	°C	-30	-20	-10	0	10	20	30	40	50
	°F	-10	0	20	40	60	80	100	120	
Smartstream G1.6 GDI HEV/PHEV		0W-16								



An engine oil displaying this American Petroleum Institute (API) Certification Mark conforms to the International Lubricant Specification Advisory Committee (ILSAC). It is recommended to only use engine oils that uphold this API Certification Mark.

### **CAUTION**

Always be sure to clean the area around any filler plug, drain plug, or dipstick before checking or draining any lubricant. This is especially important in dusty or sandy areas and when the vehicle is used on unpaved roads. Cleaning the plug and dipstick areas will prevent dirt and grit from entering the engine and other mechanisms that could be damaged.

Engine oil viscosity (thickness) has an effect on fuel economy and cold weather operating (engine start and engine oil flow ability). Lower viscosity engine oils can provide better fuel economy and cold weather performance, however, higher viscosity engine oils are required for satisfactory lubrication in hot weather.

Using oils of any viscosity other than those recommended could result in engine damage.

When choosing an oil, consider the range of temperature your vehicle will be operated in before the next oil change. Proceed to select the recommended oil viscosity from the chart.

## Vehicle Identification Number (VIN)

The Vehicle Identification Number (VIN) is the number used in registering your vehicle and in all legal matters pertaining to its ownership, etc.

Type A



The number is punched on the floor under the front right side seat. To check the number, open the cover.

Type B



The VIN is also on a plate attached to the top of the dashboard. The number on the plate can easily be seen through the windshield from outside.

## Vehicle certification label



The vehicle certification label attached on the driver's side center pillar gives the vehicle identification number (VIN).

## Tire specification and pressure label



The tires supplied on your new vehicle are chosen to provide the best performance for normal driving.

The tire label located on the driver's side center pillar gives the tire pressures recommended for your vehicle.

## Engine number

The engine number is stamped on the engine block as shown in the drawing.



## Air conditioner compressor label



A compressor label informs you the type of compressor your vehicle is equipped with such as model, supplier part number, production number, refrigerant (1) and refrigerant oil (2).

## Reporting Safety Defects

If you believe that your vehicle has a defect which could cause a crash or could cause injury or death, you should immediately inform Transport Canada (TC) in addition to notifying **Kia Canada Inc.**

Mailing Address:

Transport Canada - ASFAD  
330 Sparks Street  
Ottawa, ON  
K1A 0N5

Telephone: 819-994-3328 (Ottawa-Gatineau area or internationally)  
Toll free: 1-800-333-0510 (in Canada)

Online:

<http://www.tc.gc.ca/recalls>

If TC receives similar complaints, it may open an investigation, and if it finds that a safety defect exists in a group of vehicles, it may order a recall and remedy campaign. However, TC cannot become involved in individual problems between you, your dealer, or **Kia Canada Inc.**





# Abbreviation **A**

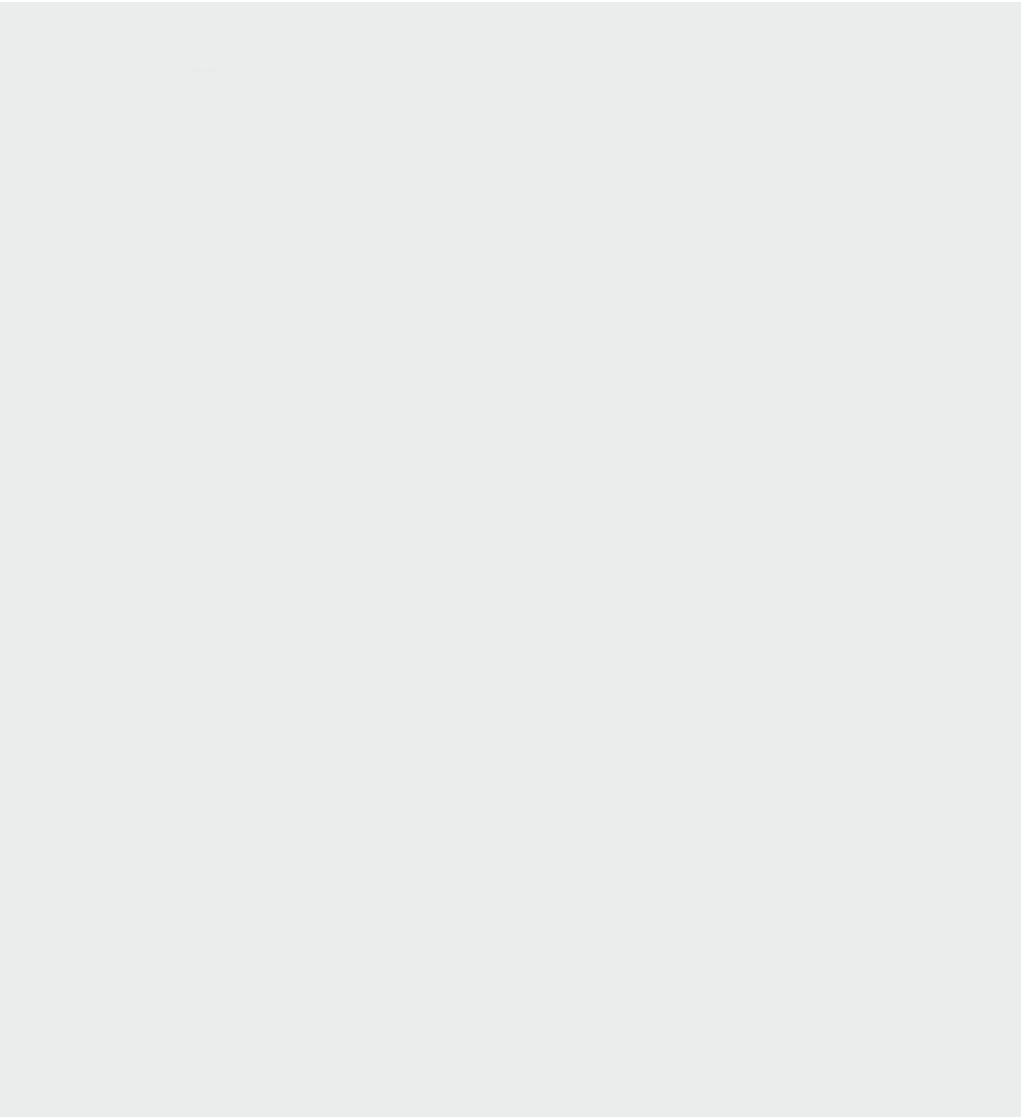

## Abbreviation

### **ABS**

Anti-lock Brake System

### **BAS**

Brake Assistant System

### **BCA**

Blind-Spot Collision-Avoidance Assist

### **CC**

Cruise Control

### **CRS**

Child Restraint System

### **DAW**

Driver Attention Warning

### **DRL**

Daytime Running Light

### **EBD**

Electronic Brake force Distribution

### **ECM**

Electric Chromic Mirror

### **EPS**

Electric Power Steering

### **ESC**

Electronic Stability Control

### **FCA**

Forward Collision-Avoidance Assist

### **HAC**

Hill-start Assist Control

### **HBA**

High Beam Assist

### **HDA**

Highway Driving Assist

### **HMSL**

High Mounted Stop Lamp

### **ISLA**

Intelligent Speed Limit Assist

### **LATCH**

Lower Anchors and Tether for Children

### **LFA**

Lane Following Assist

### **LKA**

Lane Keeping Assist

### **MIL**

Malfunction Indicator Lamp

### **MSLA**

Manual Speed Limit Assist

### **NSSC**

Navigation-based Smart Cruise Control

### **ODS**

Occupant Detection System

### **PCA**

Reverse Parking Collision-Avoidance Assist

### **PDW**

Reverse Parking Distance Warning

## Abbreviation

### **RCCA**

Rear Cross-Traffic Collision-Avoidance Assist

### **RVM**

Rear View Monitor

### **SCC**

Smart Cruise Control

### **SEW**

Safe Exit Warning

### **SRS**

Supplemental Restraint System

### **SRSCM**

SRS Control Module

### **TBT**

Turn By Turn

### **TCS**

Traction Control System

### **TIN**

Tire Identification Number

### **TPMS**

Tire Pressure Monitoring System

### **VIN**

Vehicle Identification Number

### **VSM**

Vehicle Stability Management



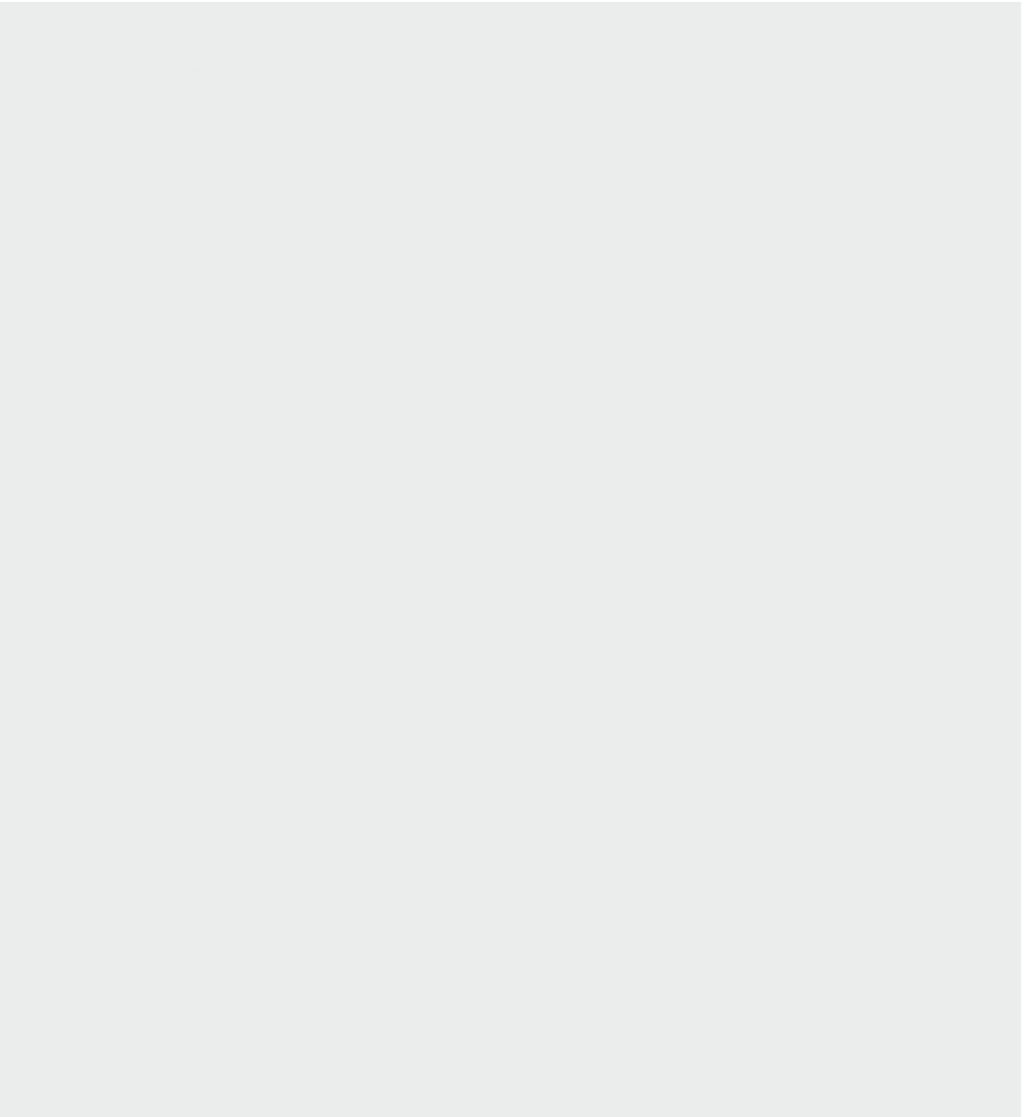

# Index

---

## A

<b>AC charge</b>	1-9
<b>AC charging connector lock</b>	1-6
<b>ac inverter</b>	5-146
<b>active air flap</b>	6-57
malfunction	6-57
<b>adjusting instrument cluster illumination</b>	5-77
<b>air bag</b>	
adding equipment to or modifying your air bag-equipped vehicle	4-53
additional safety precautions	4-52
air bag collision sensors	4-48
air bag warning labels	4-53
inflation conditions	4-49
non-inflation conditions	4-50
supplemental restraint system (SRS)	4-51
<b>air bags</b>	4-33
curtain air bag	4-46
driver's and passenger's front air bag	4-43
occupant detection system (ODS)	4-38
operation of the system	4-34
side air bag	4-45
SRS components and functions	4-36
warning light	4-35
<b>air cleaner filter</b>	8-23
<b>air ventilation seat</b>	5-144
<b>ambient light</b>	5-142
<b>anti-lock brake system (ABS)</b>	6-46
<b>appearance care</b>	8-61
exterior care	8-61
interior care	8-66
<b>armrest</b>	4-14
<b>audio system</b>	5-155
radio	5-156
USB port	5-156
<b>auto hold</b>	6-44
<b>automatic climate control system</b>	5-129
air conditioning	5-136
controlling air intake	5-135
controlling fan speed	5-136

heating and air conditioning automatically	5-132
heating and air conditioning manually	5-133
mode selection	5-134
temperature control	5-134
turning off the front air climate control	5-137
using the infotainment/climate switchable controller	5-131

---

## B

<b>battery</b>	8-28
<b>battery saver function</b>	5-113
<b>before driving</b>	6-7
<b>blind-spot collision-avoidance assist (BCA)</b>	6-85
malfunction and limitations	6-90
operation	6-88
settings	6-86
<b>brake assistant system (BAS)</b>	6-51
<b>brake fluid</b>	8-21
<b>brake system</b>	6-38
anti-lock brake system (ABS)	6-46
auto hold	6-44
brake assistant system (BAS)	6-51
electronic parking brake (EPB)	6-40
electronic stability control (ESC)	6-48
system	6-48
good braking practices	6-52
hill-start assist control (HAC)	6-50
power brakes	6-38
vehicle stability management (VSM)	6-50
system	6-50
<b>bulb replacement precaution</b>	8-55

---

## C

<b>care of seat belts</b>	4-24
<b>cargo security screen</b>	5-152
<b>center console storage</b>	5-141
<b>changing plug-in hybrid mode (plug-in hybrid vehicle)</b>	1-18
<b>charging Information</b>	1-4
<b>charging precautions</b>	1-7
<b>charging status</b>	1-5

## charging the plug-in hybrid

<b>vehicle</b>	1-4
AC charge	1-9
AC charging connector lock	1-6
charging information	1-4
charging precautions	1-7
charging status	1-5
charging time	1-4
charging type	1-4
how to disconnect charging connector	
in emergency	1-17
scheduled charging	1-6
trickle charger (portable charging cable)	1-11
<b>charging time</b>	1-4
<b>charging type</b>	1-4
<b>child restraint system (CRS)</b>	4-25
children always in the rear	4-25
installing a CRS	4-28
selecting a CRS	4-26
types	4-27
<b>climate control air filter</b>	8-24
<b>climate control system</b>	5-125
air conditioning	5-126
checking the amount of air conditioner refrigerant	5-127
checking the amount of compressor lubricant	5-127
climate control air filter	5-127
heating	5-125
system operation	5-125
ventilation	5-125
<b>closing the hood</b>	5-50
<b>coat hook</b>	5-150
<b>components of the hybrid/plug-in hybrid vehicle</b>	1-33
hybrid vehicle components	1-36
if an accident occurs	1-39
plug-in hybrid vehicle components	1-33
service interlock connector	1-38
when the hybrid vehicle shuts off	1-39
<b>coolant</b>	8-17
<b>cruise control (CC)</b>	6-115
operation	6-115
<b>cup holder</b>	5-142
<b>curtain air bag</b>	4-46

## D

<b>day/night rear view mirror</b>	5-63
<b>daytime running light (DRL)</b>	5-114
<b>declaration of conformity</b>	5-159, 6-183
<b>defogging (windshield)</b>	5-137
<b>defrosting (windshield)</b>	5-137
<b>digital key 2 touch</b>	5-22
card key	5-26
personalized profile and vehicle settings	5-29
smart phone	5-22
used vehicle/digital key 2 touch maintenance	5-32
<b>distance to empty</b>	5-80
<b>door locks</b>	5-16
child-protector rear door lock	5-20
door lock/unlock features	5-20
from inside the vehicle	5-18
rear occupant alert (ROA) system	5-21
with the mechanical key	5-17
with the smart key	5-16
<b>drive mode</b>	6-55
<b>drive mode integrated control system</b>	6-55
drive mode	6-55
<b>driver attention warning (DAW)</b>	6-110
malfunction and limitations	6-113
operation	6-111
settings	6-111
<b>driver position memory system</b>	5-33
easy access function	5-34
recalling memory positions	5-33
storing memory positions	5-33
system reset	5-33
<b>driver's and passenger's front air bag</b>	4-43
<b>driving the hybrid/plug-in hybrid vehicle</b>	1-18
energy flow	1-29
hybrid system gauge	1-21
LCD display messages	1-23
special features	1-20
starting the vehicle	1-18
warning and indicator lights	1-22

<b>driving the plug-in hybrid vehicle</b>	
changing plug-in hybrid mode (plug-in hybrid vehicle)	1-18
<b>dual clutch transmission (DCT) (Dial SBW)</b>	6-22
<b>dual clutch transmission (DCT) (dial SBW)</b>	
DCT warning messages	6-23
operation	6-22
shift lock system	6-29
transmission ranges	6-25
<b>dual clutch transmission (DCT) (shift Lever)</b>	6-14
DCT warning messages	6-16
operation	6-14
<b>dual clutch transmission (DCT) (shift lever)</b>	
shift lock system	6-20

## E

<b>easy access function</b>	5-34
<b>economical operation</b>	6-184
<b>electronic chromic mirror (ECM)</b>	5-63
<b>electronic parking brake (EPB)</b>	6-40
<b>electronic stability control (ESC) system</b>	6-48
<b>emergency</b>	7-3
emergency while driving	7-3
engine doesn't turn over	7-4
engine stalls at a crossroad or crossing	7-3
engine will not start	7-4
flat tire while driving	7-3
flat tire (with spare tire)	7-13
flat tire (with tire mobility kit)	7-21
hazard warning flasher	7-3
not start	7-4
road warning	7-3
turns over slowly	7-4
vehicle stalls while driving	7-3
<b>emission control system</b>	8-68
<b>Engine clutch actuator fluid</b>	8-22
<b>engine oil</b>	8-15
<b>engine overheats</b>	7-7
<b>engine start/stop button</b>	6-11

<b>ENGINE START/STOP button position</b>	6-11
<b>Illuminated ENGINE START/STOP button</b>	6-11
starting the engine	6-12
<b>EV button</b>	1-18
<b>exterior features</b>	5-154
roof rack	5-154

## F

<b>flat tire</b>	
removing and storing the spare tire	7-15
using of compact spare tire	7-18
<b>flat tire (with spare tire)</b>	7-13
<b>flat tire (with tire mobility kit)</b>	7-21
<b>floor mat anchor(s)</b>	5-151
<b>forward collision-avoidance assist (FCA) (Front Camera Only)</b>	6-58
malfunction and limitations	6-63
operation	6-61
settings	6-59
<b>forward collision-avoidance assist (FCA) (Sensor Fusion)</b>	6-68
malfunction and limitations	6-74
operation	6-71
settings	6-70
<b>forward/reverse parking distance warning (PDW)</b>	6-160
malfunction and precautions	6-163
operation	6-161
settings	6-161
<b>front glass heater</b>	5-141
<b>front seat adjustment for power seat</b>	4-9
<b>front seat headrest</b>	4-11
<b>fuel filler door</b>	5-51
closing the fuel filler door	5-53
opening the fuel filler door	5-51
<b>fuel gauge</b>	5-80
<b>fuel requirements</b>	2-2
<b>full LCD cluster</b>	5-76
<b>fuses</b>	8-42
driver's side fuse panel	8-47
engine compartment fuse panel	8-51
engine compartment fuse panel (battery terminal cover) (for plug-in hybrid)	8-54



engine compartment fuse replacement	8-45
inner panel fuse replacement	8-44

## G

<b>gauges</b>	5-77
distance to empty	5-80
fuel gauge	5-80
odometer	5-80
outside temperature gauge	5-81
plug-in hybrid mode indicator	5-79
power gauge	5-78
SOC gauge	5-78
speedometer	5-77
<b>glove box</b>	5-142
<b>green zone drive mode for Europe</b>	6-56

## H

<b>headlamp delay function</b>	5-113
<b>headrest</b>	4-11
front seat headrest	4-11
rear seat headrest	4-14
<b>head-up display (HUD)</b>	5-112
<b>heated steering wheel</b>	5-61
<b>HEV (hybrid electric vehicle) system</b>	1-3
<b>hev powertrain</b>	2-8
<b>high beam assist (HBA)</b>	5-117
malfunction and limitations	5-118
operation	5-117
setting	5-117
<b>highway driving assist (HDA)</b>	6-139
malfunction and limitations	6-143
operation	6-141
settings	6-140
<b>hill-start assist control (HAC)</b>	6-50
<b>HomeLink® system</b>	5-63
<b>hood</b>	5-49
closing the hood	5-50
opening the hood	5-49
<b>hybrid starter &amp; generator (hsg) belt</b>	8-20
<b>hybrid system overview</b>	1-2
<b>hybrid vehicle components</b>	1-36

## I

<b>immobilizer system</b>	5-11
folding key immobilizer system	5-11
smart key immobilizer system	5-12
<b>Important safety precautions</b>	4-3
<b>indicator lights</b>	5-108
<b>infotainment system</b>	5-155
audio system	5-155
using the infotainment/climate switchable controller	5-155
<b>inside rear view mirror</b>	5-62
day/night rear view mirror	5-63
HomeLink® system	5-63
<b>instrument cluster</b>	5-75
adjusting instrument cluster illumination	5-77
dual clutch transmission shift indicator	5-81
full LCD cluster	5-76
gauges	5-77
plug-in hybrid mode indicator	5-79
transmission shift indicator	5-81
<b>intelligent speed limit assist (ISLA)</b>	6-104
malfunction and limitations	6-108
operation	6-107
settings	6-105
<b>interior features</b>	5-142
ac inverter	5-146
air ventilation seat	5-144
ambient light	5-142
cargo security screen	5-152
coat hook	5-150
cup holder	5-142
floor mat anchor(s)	5-151
power outlet	5-147
seat warmer	5-143
sun visor	5-145
USB charger	5-145
wireless smart phone charging system	5-147
<b>interior light</b>	5-123
automatic turn off function	5-123
glove box lamp	5-125
luggage room lamp	5-124
map lamp	5-123
room lamp	5-124

vanity mirror lamp 5-125

---

## K

**key positions** 6-9

ignition switch position 6-9

illuminated ignition switch 6-9

starting the engine 6-10

**keys** 5-6

battery replacement 5-10

remote key 5-6

smart key 5-6

---

## L

**lane following assist (LFA)** 6-136

malfunction and limitations 6-139

operation 6-137

settings 6-136

**lane keeping assist (LKA)** 6-80

malfunction and limitations 6-83

operation 6-82

settings 6-80

**LCD display** 5-82

LCD display modes 5-83

**LCD display messages** 5-96

**LCD display modes**

driver assistance settings

(infotainment system) 5-91

**LCD displays** 5-92

LCD display messages 5-96

service mode 5-95

trip information (trip computer) 5-92

**liftgate** 5-35

closing the liftgate 5-36

emergency liftgate safety release 5-36

opening the liftgate 5-35

**light bulbs** 8-55

bulb replacement precaution 8-55

light bulb position (front) 8-56

light bulb position (rear) 8-56

light bulb position (side) 8-57

**lighting** 5-113

battery saver function 5-113

daytime running light (DRL) 5-114

front fog light 5-116

headlamp delay function 5-113

high beam assist (HBA) 5-117

lighting control 5-114

one-touch lane change 5-116

operating high beam 5-115

operating turn signals 5-116

**lighting control** 5-114

auto light 5-115

head light (low beam) 5-114

position and tail lamp 5-114

**luggage board** 5-151

**luggage net holder** 5-151

---

## M

**maintenance**

battery 8-28

brake fluid 8-21

climate control air filter 8-24

coolant 8-17

engine clutch actuator fluid 8-22

engine oil 8-15

fuses 8-42

hybrid starter & generator (hsg) belt 8-20

lights bulbs 8-55

maintenance services 8-5

owner maintenance 8-6

tires and wheels 8-31

washer fluid 8-23

wiper blades 8-25

**manual speed limit assist**

**(MSLA)** 6-102

operation 6-102

**mirrors** 5-62

electronic chromic mirror (ECM) 5-63

inside rear view mirror 5-62

outside rear view mirror 5-72

---

## N

**navigation-based smart cruise**

**control (NSCC)** 6-131

limitations 6-134

operation 6-132

settings 6-132

---

## O

**occupant detection system**

**(ODS)** 4-38

<b>odometer</b>	5-80	<b>settings</b>	6-146
<b>one-touch lane change</b>	5-116	<b>regenerative braking system</b>	
<b>open source software notice</b>	2-6	adjusting with paddle shifter	6-31
<b>opening the hood</b>	5-49	<b>remote smart parking assist (RSPA)</b>	6-172
<b>outside rear view mirror</b>	5-72	malfunction and precautions	6-179
adjusting the outside rear view mirror	5-72	operation	6-174
folding the outside rear view mirror	5-73	settings	6-173
reverse parking aid function	5-73	<b>reverse parking collision-avoidance assist (PCA)</b>	6-165
<b>outside temperature gauge</b>	5-81	malfunction and precautions	6-168
		operation	6-167
		settings	6-165

## P

<b>paddle shifter</b>	6-30	<b>reverse parking distance warning (PDW)</b>	6-157
<b>PHEV (plug-in hybrid electric vehicle) system</b>	1-2	malfunction and precautions	6-159
<b>plug-in hybrid mode indicator</b>	5-79	operation	6-158
<b>plug-in hybrid vehicle components</b>	1-33	settings	6-157
<b>portable charge</b>		<b>risk of burns when parking or stopping vehicle</b>	2-6
charging status indicator lamp for portable charger	1-14	<b>roof rack</b>	5-154
how to connect	1-11		
<b>power gauge</b>	5-78		
<b>power liftgate</b>	5-37		
emergency liftgate safety release	5-41		
operating the power liftgate	5-39		
resetting the power liftgate	5-41		
setting the power liftgate	5-40		
<b>power outlet</b>	5-147		
<b>power window lock button</b>	5-48		
<b>pre-tensioner seat belt</b>	4-22		

## R

<b>rear cross-traffic collision-avoidance</b>	6-150	<b>safe exit assist (SEA)</b>	6-98
<b>rear cross-traffic collision-avoidance assist (RCCA)</b>	6-149	malfunction and limitations	6-100
malfunction and limitations	6-154	operation	6-99
operation	6-151	settings	6-98
<b>rear occupant alert (ROA) system</b>	5-21	<b>safe exit warning (SEW)</b>	6-94
<b>rear seat headrest</b>	4-14	malfunction and limitations	6-96
<b>rear view monitor (RVM)</b>	6-146	operation	6-95
malfunction and limitations	6-148	settings	6-95
operation	6-147	<b>scheduled charging</b>	1-6
		<b>scheduled maintenance items</b>	8-13
		air cleaner filter	8-13
		air conditioning refrigerant	8-14
		automatic transmission fluid	8-13
		brake discs, pads and calipers	8-14
		brake fluid	8-14
		brake hoses and lines	8-13
		coolant	8-13
		cooling system	8-13
		drive shafts and boots	8-14
		Exhaust pipe and muffler	8-14
		fluid levels	8-14
		fuel lines, fuel hoses and connections	8-13
		Fuel tank and fuel cap	8-13
		spark plugs	8-13

steering gear box, linkage & boots/lower arm ball joint	8-14	air conditioning system	9-3
suspension mounting bolts	8-14	bulb wattage	9-4
<b>scheduled maintenance service</b>	8-8	dimensions	9-2
<b>scheduled maintenance service precaution</b>	8-8	engine	9-2
<b>seat</b>	4-5	engine number	9-8
feature of seat leather	4-7	gross vehicle weight	9-3
folding the rear seat	4-14	lubricants and capacities	9-6
front seat adjustment for manual seat	4-8	luggage volume	9-3
front seat adjustment for power seat	4-9	tire specification and pressure label	9-8
infotainment system	4-8	tires and wheels	9-5
seatback pocket	4-13	vehicle certification label	9-8
<b>seat belts</b>	4-17	vehicle identification number (VIN)	9-8
3-point system with emergency locking retractor	4-19	<b>speedometer</b>	5-77
care of seat belts	4-24	<b>starting the engine</b>	
precautions	4-23	starting the engine	6-14
pre-tensioner seat belt	4-22	<b>starting the engine with smart key</b>	6-13
<b>seat warmer</b>	5-143	<b>starting the gasoline engine</b>	6-14
<b>seatback pocket</b>	4-13	<b>steering wheel</b>	5-59
<b>service interlock connector</b>	1-38	electric power steering (EPS)	5-59
<b>service mode</b>	5-95	heated steering wheel	5-61
<b>side air bag</b>	4-45	horn	5-62
<b>smart cruise control (SCC)</b>	6-118	tilt & telescopic steering wheel	5-60
malfunction and limitations	6-126	<b>storage compartment</b>	5-141
operation	6-120	center console storage	5-141
settings	6-119	glove box	5-142
<b>smart key</b>	5-6	luggage board	5-151
mechanical key	5-8	luggage net holder	5-151
operation	5-7	<b>sun visor</b>	5-145
<b>smart liftgate with auto open</b>	5-42	<b>sunroof</b>	5-56
detecting area	5-44	automatic reversal	5-57
how to deactivate	5-43	resetting the sunroof	5-58
how to use	5-42	slide open/close	5-57
<b>smart regeneration system</b>	6-33	sunroof open warning	5-59
activation	6-33	sunshade	5-56
basic setting of smart regeneration system	6-35	tilt open/close	5-56
limitation	6-36		
malfunction	6-35	<b>T</b>	
resuming	6-34	<b>theft-alarm system</b>	5-14
setting	6-33	armed stage	5-14
<b>SOC gauge</b>	5-78	disarmed stage	5-15
<b>special driving conditions</b>	6-185	theft-alarm stage	5-14
<b>specifications</b>	9-2	<b>tire pressure monitoring system (TPMS)</b>	7-9
air conditioner compressor label	9-9	effective use of the TPMS	7-9
		tire replacement with TPMS	7-12

<b>tires and wheels</b>	8-31	<b>vehicle modifications</b>	2-5
all season tires	8-40	<b>vehicle settings (infotainment system)</b>	5-91
checking tire inflation pressure	8-32	<b>vehicle stability management (VSM) system</b>	6-50
low aspect ratio tire	8-41	<b>vehicle weight</b>	6-195
radial-ply tires	8-41	base curb weight	6-195
snow tires	8-40	cargo weight	6-195
summer tires	8-40	GAW (gross axle weight)	6-195
tire maintenance	8-34	GAWR (gross axle weight rating)	6-196
tire replacement	8-33	GVW (gross vehicle weight)	6-196
tire rotation	8-32	GVWR (gross vehicle weight rating)	6-196
tire sidewall labeling	8-34	overloading	6-196
tire terminology and definitions	8-37	vehicle curb weight	6-195
tire traction	8-34		
wheel alignment and tire balance	8-33		
wheel replacement	8-34		
<b>towing</b>	7-26		
without wheel dollies	7-28		
<b>transmission shift indicator</b>	5-81		
<b>trickle charger (portable charging cable)</b>	1-11		
<b>trip information (Trip computer)</b>			
energy flow	5-96		
range	5-96		
<b>trip information (trip computer)</b>			
accumulated driving information mode	5-94		
drive info display	5-93		
fuel economy	5-93		
information since refueling	5-94		
trip modes	5-92		
<hr/>			
<b>U</b>			
<b>USB charger</b>	5-145		
<b>using the infotainment/climate switchable controller</b>	5-155		
<hr/>			
<b>V</b>			
<b>vehicle auto shut-off system</b>	6-54		
<b>vehicle break-in process</b>	2-5		
<b>vehicle data collection and event data recorders</b>	2-7		
<b>vehicle handling instructions</b>	2-6		
<b>vehicle identification number (VIN)</b>	9-8		
<b>vehicle load limit</b>	6-192		
		<b>W</b>	
		<b>warning and indicator lights</b>	5-102
		indicator lights	5-108
		warning lights	5-102
		<b>warning lights</b>	5-102
		<b>washer fluid</b>	8-23
		<b>welcome system</b>	5-122
		<b>window opening and closing</b>	5-46
		<b>windows</b>	5-45
		power window lock button	5-48
		window opening and closing	5-46
		<b>windshield defrosting and defogging</b>	5-137
		defogging logic	5-140
		defroster	5-139
		front glass heater	5-141
		<b>winter driving</b>	6-189
		<b>wiper blades</b>	8-25
		<b>wipers and washers</b>	5-119
		<b>wireless smart phone charging system</b>	5-147

